

The Gifts
Collection

Gifts
to make
your brand
unique

Index 2023

01	Technology and Accessories	04-75
02	Home and Kitchen	76-141
03	Food and Beverage	142-147
04	Dining and Drinkware	148-241
05	Rain and Umbrellas	242-263
06	Personal and Care	264-339
07	Caps and Accessories	340-359
08	Writing and Gifts	360-421
09	Business and Office	422-485
10	Travel and Business	486-523
11	Shopping and Bags	524-579
12	Children and Games	580-619
13	Leisure and Outdoor	620-633
14	Summer and Beach	634-687
15	Pets and Accessories	688-693
16	Fitness and Wellness	694-743
17	Tools and Torches	744-773
18	Events and Festivals	774-797
19	Packaging and Solutions	798-813

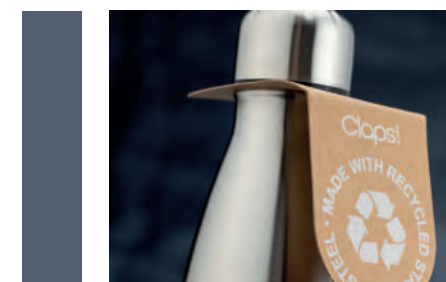

COLLECTION 100% CERTIFIED SECURITY AND QUALITY

La sicurezza e la qualità dei nostri prodotti è diventata fondamentale. Durante tutte le fasi di produzione ci assicuriamo che vengano rispettate le principali norme Europee garantendo un prodotto 100% certificato secondo le vigenti normative.

Security and quality control has become essential for us. We make sure that all production phases are in accordance with main European regulations in force; by doing this, we guarantee that our products are 100% certified according to these standards.

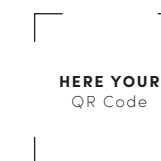

Nel catalogo le misure menzionate sono indicative. Ci riserviamo il diritto di effettuare le opportune modifiche dove è necessario. Colori e misure potrebbero cambiare, lasciando inalterata la tipologia del prodotto.

In this catalogue all the mentioned measures are indicative, we keep the right to make the appropriate changes if necessary. Colours and measures can change, leaving the product typology unchanged.



Technology and Accessories
04-75



Home and Kitchen
76-141



Dining and Drinkware
148-241

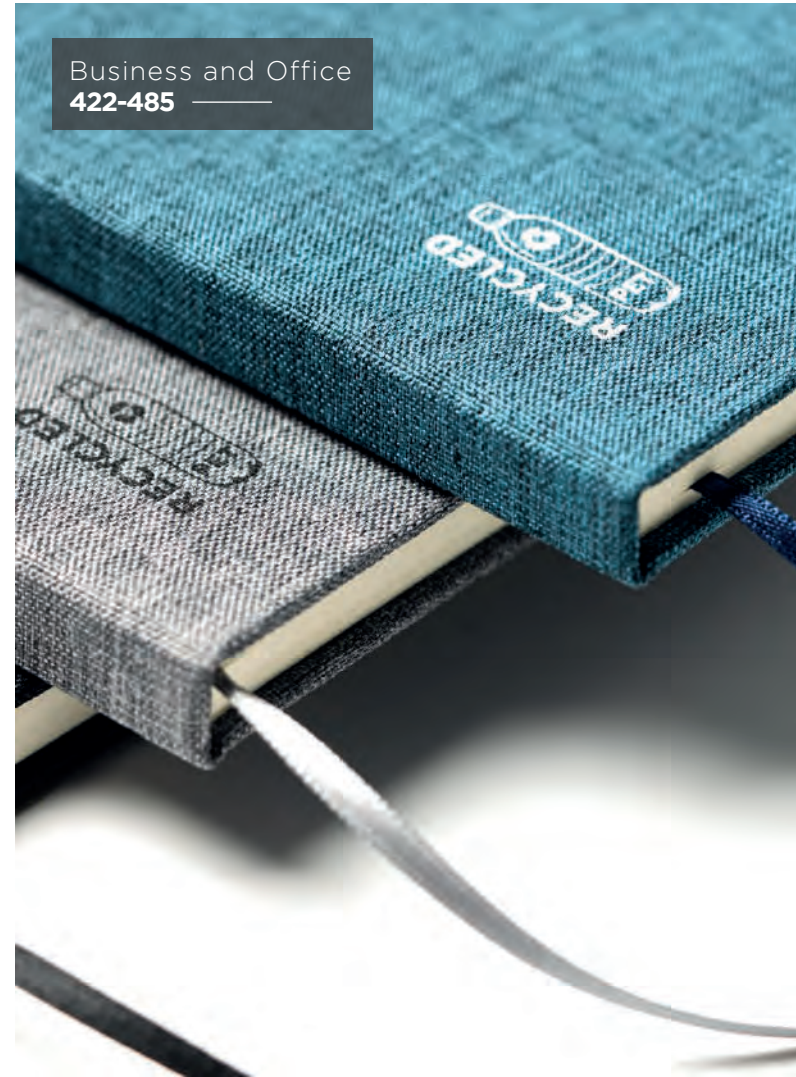

Business and Office
422-485



Travel and Business
486-523



Leisure and Outdoor
620-633

2023 THE GIFTS COLLECTION



Rain and Umbrellas
242-263



Writing and Gifts
360-421



Shopping and Bags
524-579



Fitness and Wellness
694-743



Summer and Beach
634-687



Tools and Torches
744-773

Technology and Accessories

Power bank, basi di ricarica, lampade, sveglie multifunzione, speaker e auricolari bluetooth, hub USB da scrivania, mouse, tappetini mouse, chiavette USB, supporti per smartphone e molto altro...

Power banks, charging bases, lamps, multifunctional alarm clocks, bluetooth speakers and headsets, desktop USB hubs, computer mouse, mouse pads, USB flash drives, smartphone holders, and more...

Technology and Accessories



WIRELESS CHARGER

Compatible with devices that include wireless charger features.



26325
Bryan



Base di ricarica. Include cavo da 30cm. Dotato di protezione NTC. Compatibile con dispositivi con tecnologia di ricarica wireless. | Wireless charger, included a cable of 30 cm long. It has NTC protection. Compatible with devices that include wireless charger features.

Bamboo | bamboo

9 x 0,9 cm



26316
Fofi



Caricabatterie wireless con base in cemento calcareo e supporto in bambù. Compatibile con i modelli con tecnologia wireless. | Wireless charger with square base in limestone cement and rectangular stand in natural bamboo. Compatible with wireless technology models.

Cemento calcareo, Bamboo | Limestone cement, Bamboo

9,4 x 12,5 x 9,4 cm



26327
Fumo



Caricatore wireless 5W con supporto per smartphone e tablet integrato. Corpo in legno di bambù naturale. Include un cavo micro USB da 1m. | 5W nature line wireless charger, with integrated holder for smartphones and tablets. Case in bamboo. Includes 1m micro USB cable.

Bamboo | bamboo

12,5 x 1,6 x 8 cm



2 OUTPUT USB 3.0



.00



26550
Tallio



Caricatore wireless. Carica fino a 3 dispositivi simultaneamente. Compatibile con i modelli con tecnologia di ricarica wireless. Cavo incluso. | Wireless charger. Charges up to 3 devices simultaneously. Compatible with models with wireless charging technology. Cable included.

Bamboo | bamboo

9 x 9 x 0,9 cm



.02



26304
Kristo



Caricabatterie wireless 5W con corpo in ABS bianco e superficie in bambù naturale. Cavo incluso. | 5W wireless charger with white ABS body and natural bamboo top surface. Cable included.

Plastica, Bamboo | Plastic, Bamboo

Ø 6 x 1 cm





26485
Yara

Base di ricarica wireless in bambù, adatta a 2 dispositivi. Indicatore LED. Include cavo type C. | Wireless charging base made of bamboo for two devices. 5W power. Led indicator. Includes type C cable.

Bamboo | bamboo

19 x 7 x 1,1 cm

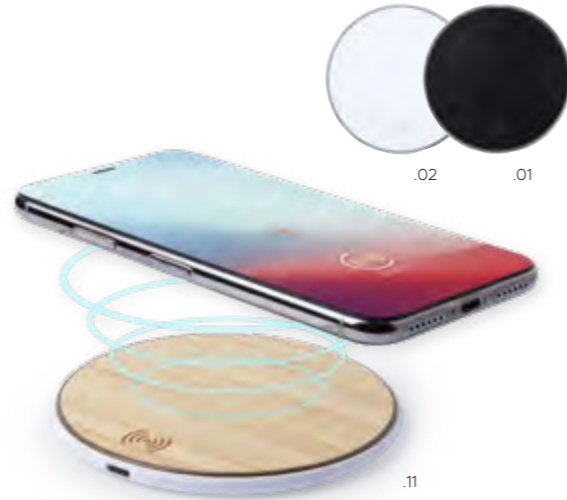

26263
Zhalpaktl

Caricatore wireless con tecnologia Qi. Base antiscivolo. Cavo USB incluso. | Wireless charger with Qi technology and charging base. Non-slip base. USB cable included.

Bamboo | bamboo

0,7 x Ø10 cm



26354
Fiastrone

Supporto telefono con caricatore wireless integrato. Cavo incluso. | Phone stand with built-in wireless charger. Cable included.

Bamboo | bamboo

7 x 11,5 x 8 cm



26543
Escallonia

Portapenne con supporto telefono con caricatore wireless integrato. Potenza di ricarica 1W. | Pencil holder with built-in smartphone stand with wireless charger. Charging power 1W.

Bamboo | bamboo

7,7 x 11,2 x 7 cm



WHEAT FIBER



.13

WIRELESS CHARGER

Compatible with devices equipped with wireless technology



26424
Sonso

Caricatore wireless realizzato in fibra di grano. Compatibile con dispositivi dotati di tecnologia wireless, DC5V. Comprende cavo micro usb. | Wireless charger made of wheat fiber. Compatible with devices equipped with wireless technology, DC5V. Includes micro usb cable.

Fibra di grano, Abs | Wheat Fiber, Abs

1 x Ø 7 cm



.13



26569
Agordo

Portapenne multifunzione. Include supporto per smartphone, caricabatteria wireless potenza 5W e tre porte USB. Cavo micro USB incluso. | Multifunctional pen holder. Includes smartphone holder, 5W wireless charger and three USB ports. Micro USB cable included.

Fibra di grano | Wheat fiber

8,5 x 9 x 10 cm



PEN HOLDER

WHEAT FIBER



WIRELESS CHARGING





NATURAL CORK
WHEAT FIBER



26529
Acidanthera



Caricabatterie wireless in sughero e fibra di grano. DC5V. Cavo incluso. | Wireless charger with body in natural cork and wheat fibre. DC5V. Cable included

Sughero | Cork

1,9 x 9 cm



NATURAL CORK



26538
Acero



Portapenne con caricatore wireless. 2 porte USB DC5V. | Pencil holder with built-in wireless charger, additional USB ports. DC5V.

Sughero | Cork

15,2 x 10,6 x 10,6 cm



RECYCLED CARDBOARD



26599
Roana



Base wireless realizzata in bamboo e cartone FSC. Cavo RTPE Type C incluso | Wireless base with RTPE Type C cable

Cartone FSC, Bamboo FSC | FSC cardboard, FSC bamboo

13,8 x 7,3 x 1,6 cm



**BAMBOO
DESK TRAY**

Wireless charger, in-built on a desk tray. White cable included



26504
Genio



Caricatore wireless in bambù naturale integrato nel vassoio organizer. Compatibile con i modelli con tecnologia di ricarica wireless. Cavo bianco incluso. | Wireless charger in natural bamboo, in-built on a desk tray. White cable included.

Bambù | bamboo

27 x 14,5 x 1,5 cm





WIRELESS CHARGING



26308
Ares



Orologio con caricatore wireless integrato. Funzione data e orologio, sveglia e termometro. Compatibile con i dispositivi wireless. 3 modalità di luce. | Clock with integrated wireless charger. With time and date functions, alarm and thermometer. 3 lighting positions, with micro USB cable included and compatible with devices equipped with wireless charging technology.

Legno | Wood

16 x 2,8 x 7,8 cm



.00



WIRELESS CHARGING

PHOTO FRAME

NATURAL CORK



49130
Altavilla



Cornice porta foto con caricatore wireless integrato, realizzata in sughero. Ideale per foto dimensione 10x15cm. Cavo incluso. | Photo frame with integrated wireless charger, made of cork. Ideal for 10x15cm size photos. Cable included.

Sughero | Cork

17,6 x 21 cm



.00



WIRELESS CHARGING

.11



WIRELESS CHARGING

.11



26568
Agugliaro



Orologio sveglia multifunzione con base di ricarica wireless, sensore di temperatura, controllo automatico della luminosità, possibilità di impostare 3 sveglie. Il display mostra orologio, data e temperatura. | Multifunctional alarm clock with wireless charging base, temperature sensor, automatic brightness control, possibility to set 3 alarms. The display shows the clock, date and temperature.

Bambù | bamboo

16 x 4 x 7,5 cm



26588
Polesine



Orologio da tavolo in bambù, con caricatore wireless integrato. Funzionalità: ora, data, allarme e temperatura. Connessione di tipo C. Cavo incluso. | Bamboo table clock, with built-in wireless charger. Functionality: time, date, alarm and temperature. Type C connection. Cable included.

Bambù | bamboo

16 x 3,7 cm



.11



49132
Scodosia



Caricabatterie wireless con cornice. Ideale per fotografie 10 x 15 cm. Compatibile con i dispositivi dotati di tecnologia wireless. Potenza 10 W. Cavo incluso. | Wireless charger with frame. Ideal for 10 x 15 cm photographs. Compatible with devices equipped with wireless technology. Power 10 W. Cable included.

Bambù | bamboo

20,5 x 16,5 cm



.11



26567
Albaredo



Caricatore wireless 2 in 1. Cornice porta foto in acrilico integrata. Fornito con cavo. | 2 in 1 wireless charger Integrated acrylic photo frame. Supplied with cable

Bambù, plastica acrilica | Bamboo, acrylic plastic

Acrylic: 10 x 13 cm / Base: 10 x 10 x 1,2 cm



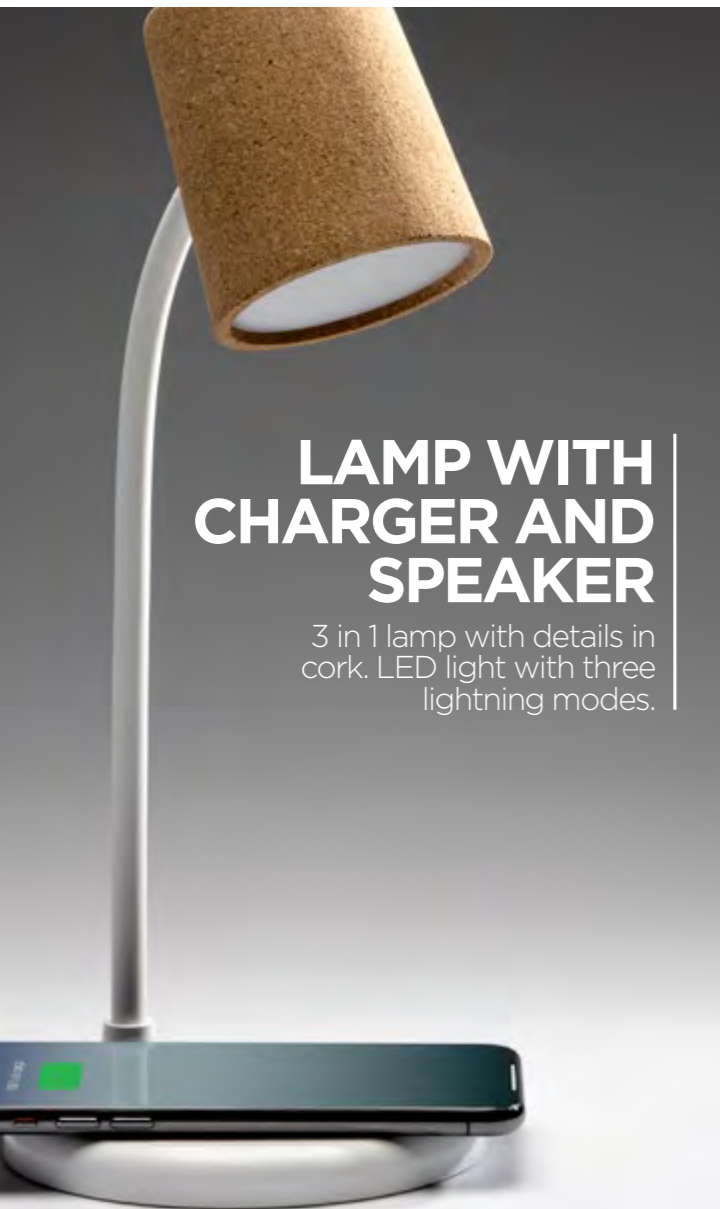

LAMP WITH CHARGER AND SPEAKER

3 in 1 lamp with details in cork. LED light with three lightning modes.



85062
Possagno



Lampada da tavolo con dettagli in sughero, con caricatore wireless integrato sulla base e speaker wireless. Luce LED con tre modalità di illuminazione. | Table lamp with cork details, with integrated wireless charger on the base and wireless speaker. LED light with three lighting modes.

Plastica, Sughero | Plastic, Cork

33 x 12 cm



BAMBOO FOLDABLE LAMP

Wireless charging base. LED lights with lightning and intensity modes.

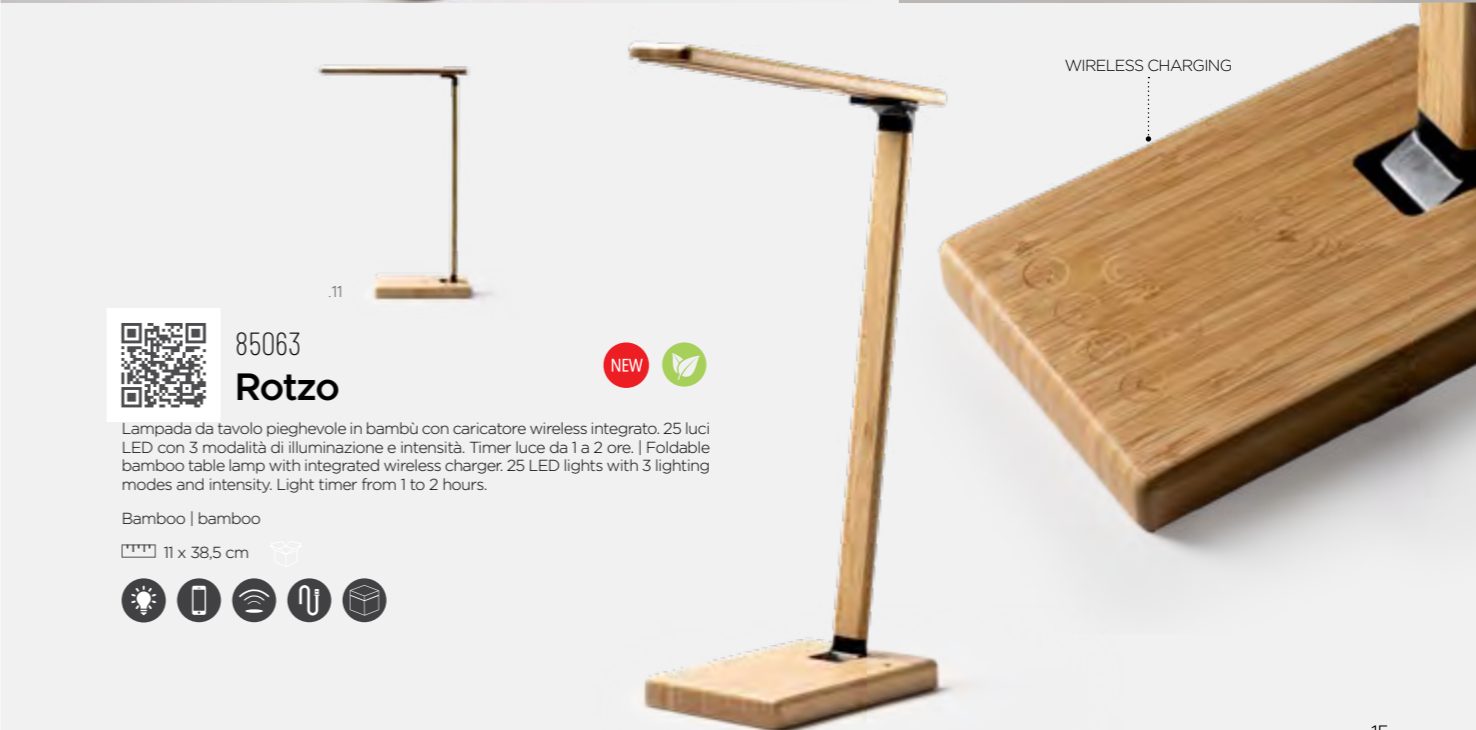

85063
Rotzo



Lampada da tavolo pieghevole in bambù con caricatore wireless integrato. 25 luci LED con 3 modalità di illuminazione e intensità. Timer luce da 1 a 2 ore. | Foldable bamboo table lamp with integrated wireless charger. 25 LED lights with 3 lighting modes and intensity. Light timer from 1 to 2 hours.

Bamboo | bamboo

11 x 38,5 cm



BAMBOO POWERBANK

6000mAh bamboo powerbank with wireless charging. Includes type C cable



6000 mAh



.11



26573 Albettone



Powerbank da 6000mAh in bambù con ricarica wireless. Uscita DC5V/2.1A. Wireless da DC5V. Include cavo tipo C. | 6000mAh bamboo powerbank with wireless charging. DC5V/2.1A output. Wireless from DC5V. Includes type C cable

Bamboo | bamboo

7,5 x 14,5 x 1,6 cm



26561 Shanghai



Powerbank con pannello solare. Una uscita USB, due ingressi microusb e type c. Indicatore di ricarica led. Cavo incluso. | Powerbank with solar panel. One USB output, two microusb and type c inputs. LED charging indicator. Cable included.

Bamboo | bamboo

7,3 x 15,5 cm



.11



.11



26486 Decibel



Powerbank con base di ricarica wireless. Potenza 5W. Indicatore LED. Include cavo. | Powerbank with wireless charging base of 5W power. Led indicator. Includes cable

Bamboo | bamboo

6,8 x 14,5 x 1,6 cm



.11



26514 Kuka



Powerbank con corpo rettangolare in ABS bianco e superficie in bambù. Include un cavo Micro USB. | Powerbank with rectangular white ABS body and bamboo top surface. Micro USB cable included.

Plastica, Bamboo | Plastic, Bamboo

10,1 x 6,3 x 1,5 cm





PLASTIC POWERBANK

With a large printing area with matching colour carrying keychain



26333
Kalix

Powerbank con ampia superficie di stampa. Portachiavi colorato coordinato. | Powerbank with a large printing area with matching colour carrying keychain.

Plastica | Plastic

9,7 x 2,3 x 2,6 cm



26368
Kurgan

Powerbank da 2200mAh, in alluminio, cavo di ricarica microusb escluso. Ampia superficie di stampa, particolarmente adatto all'incisione laser. Fornito in confezione singola. | 2.200 mAh, external auxiliary battery. In aluminium, micro usb cable excluded. Large printing surface, especially recommended for laser. Presented in an attractive design box.

Alluminio | Aluminum

9,4 x 2,2 x 2,1 cm

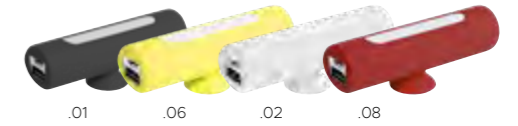

26340
Rapids

Powerbank dotato di ventosa per attaccarlo al retro del dispositivo. Cavo microusb, superficie frontale in plastica. | Powerbank in cylindrical rubber design and suction cups for attaching to the rear of the device. With micro USB cable and plastic front printing surface.

Plastica, Silicone | Plastic, Silicone

3,2 x 2,5 x 9,6 cm



26341
Rapinafis

Powerbank con indicatore di carica e cavo microusb. | Powerbank with charging indicators and micro USB cable.

Plastica | Plastic

10 x 2,4 x 2,7 cm



26388
Grignasco

Powerbank cilindrico. Ingresso microusb e uscita USB. Cavo non incluso. | Cylindrical powerbank. Micro usb input, USB output. Cable not included.

Plastica | Plastic

10 x Ø 2,5 cm



26520
Kraker

Powerbank con indicatore di carica LED. Include cavo con collegamento USB e micro USB. | Powerbank with LED charging indicator. Includes cable with USB connection and Micro USB.

Alluminio | Aluminum

9,4 x 2,2 x 2,1 cm



26214
Heliotrope

Powerbank con cavo microusb e laccetto coordinati. Fornito in custodia singola. | Powerbank with micro USB cable and matching colour carrying strap.

Plastica | Plastic

9,7 x 4,5 x 2,3 cm





26303
Fiamma

Powerbank per ricarica wireless. Funzione di fissaggio tramite ventose. Indicatore di carica LED. Include cavo Micro USB. | Powerbank for wireless charging. Fixing function by suction cups. LED charging indicator. Micro USB cable included.

Abs | Abs

10,4 x 1,6 x 6,5 cm

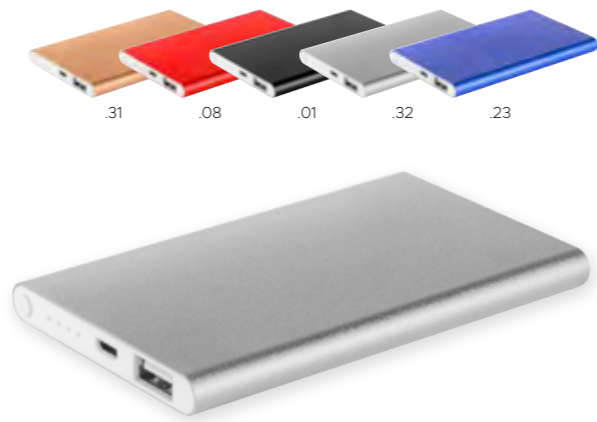

26347
Charoite

Powerbank con indicatore di ricarica e pulsante di accensione. Include cavo di ricarica. | Powerbank with charge indicator, power button. It includes cable.

Alluminio | Aluminum

11 x 1 x 7 cm



26232
Giatrus

Powerbank con pannello solare. Resistente all'acqua e con rivestimento in silicone, doppia porta USB per caricare contemporaneamente due dispositivi. Con segnale LED di emergenza. Include cavo micro usb. | Powerbank for solar recharging. Water resistant and silicone coated. Featuring dual USB output, charging indicators. With a powerful SOS LED signal.

Plastica | Plastic

14,3 x 7,7 x 1,6 cm



26289
Fausta

Powerbank bicolore. Indicatore di carica LED. Include cavo Micro USB. | Two-color powerbank. LED charging indicator. Micro USB cable included.

Abs | Abs

14,4 x 7,7 x 1,4 cm



26891
Kangasniemi

Powerbank con funzione di ricarica wireless. 2 ingressi (type-c e microusb), 2 uscite USB. Con ventose per attaccarlo al retro del dispositivo. Cavo incluso. | Powerbank with wireless charging. It includes Micro USB and Type C entry, USB output. 5W power. Charging led indicators. Power button. Cable included.

Abs | Abs

7 x 2 x 13,5 cm

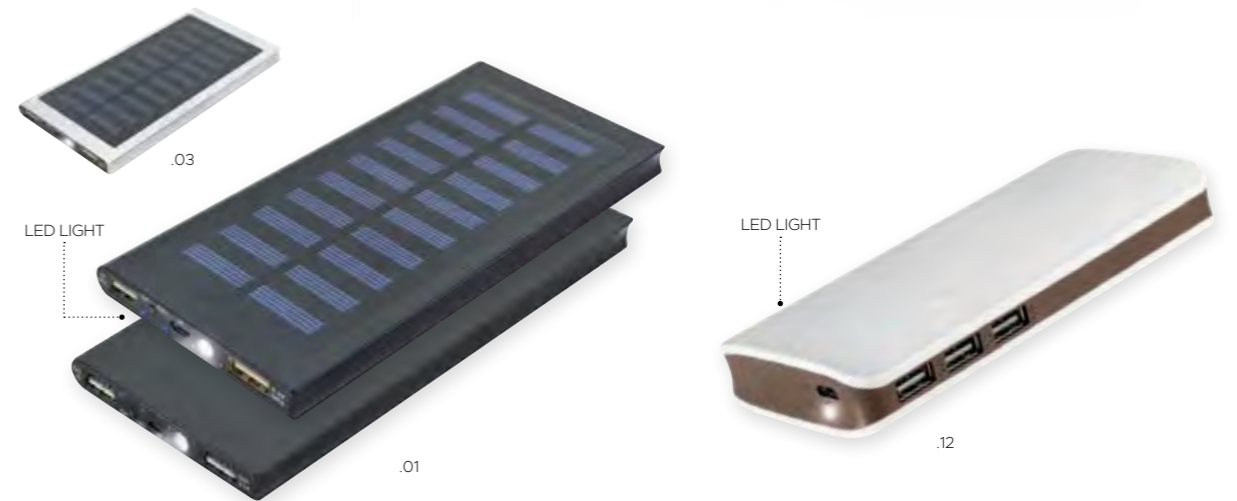

26564
Hangzhou

Powerbank da 8000mAh, dotato di 2 uscite USB per caricare contemporaneamente fino a 2 dispositivi. Ingresso micro USB. Indicatore di ricarica LED. Dotato di luce LED. | 8000mAh powerbank, equipped with 2 USB outputs to charge up to 2 devices at the same time. Micro USB input. LED charging indicator. Equipped with LED light.

Alluminio | Aluminum

7,5 x 15,4 cm



26068
Gemona

Powerbank con indicatore di ricarica, 3 porte USB per caricare fino a 3 dispositivi contemporaneamente. Ampia superficie di stampa. | Powerbank with charging indicator, 3 USB ports to charge up to 3 devices at the same time. Large print surface.

Plastica | Plastic

6,5 x 14,3 x 2,2 cm





26548
Taklia

Base di ricarica wireless da 15W. Ampia superficie di stampa. Compatibile con dispositivi dotati di sistema di ricarica wireless. | 15W wireless charging base. Large printing surface. Compatible with devices equipped with wireless charging technology

Abs, Alluminio | Abs, Aluminum

☐ 9,8 x 0,65 cm



26235
Ektorp

Base di ricarica wireless bianca con tecnologia Qi. Due porte usb da 2100mAh. Base antiscivolo. Compatibile con dispositivi con tecnologia di ricarica wireless. | Wireless charger with Qi technology. 2,100 mAh dual USB output. With non-slip base. Compatible with devices equipped with wireless charging technology.

Plastica | Plastic

☐ 9 x 0,9 x 9 cm

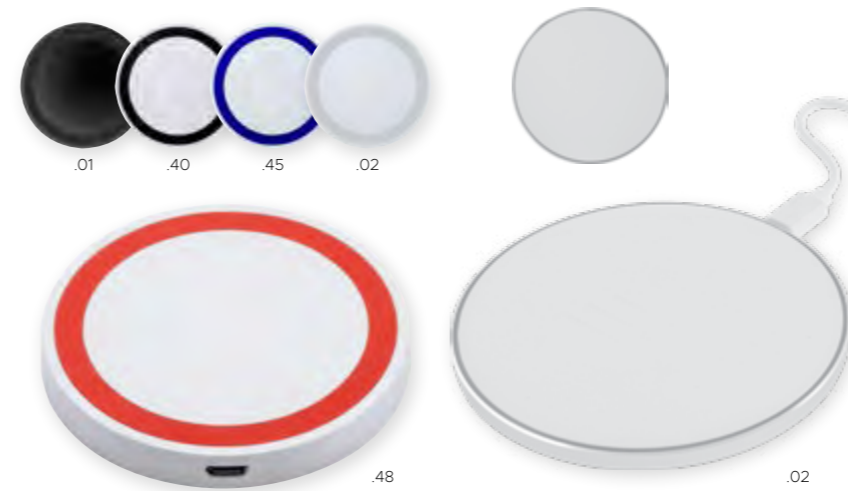

26290
Hämeenkyrö

Base di ricarica wireless con tecnologia Qi. Con base antiscivolo. Cavo incluso. Compatibile con dispositivi dotati di tecnologia di ricarica wireless. | Wireless charger with Qi technology. With non-slip base. Cable included. Compatible with devices equipped with wireless charging technology.

Abs | Abs

☐ 7 x 0,9 cm



26210
Mindy

Set powerbank, caricatore auto e caricatore da parete. Fornito in custodia. | Set of powerbank, car lighter charger and wall charger in cheerful colours. Presented in a resistant PU leather case in matching colours.

Similpelle, Plastica | Leatherette, Plastic

☐ 7,5 x 11,5 x 4 cm



26899
Kalajoki

Base di ricarica wireless con ricarica rapida e tecnologia Qi. Potenza 10W. Fornito in confezione regalo | Quick charge wireless base with Qi technology, 10W power. Presentation in black gift box. Cable included

Metallo, Abs | Metal, Abs

☐ 10 x 0,9 cm

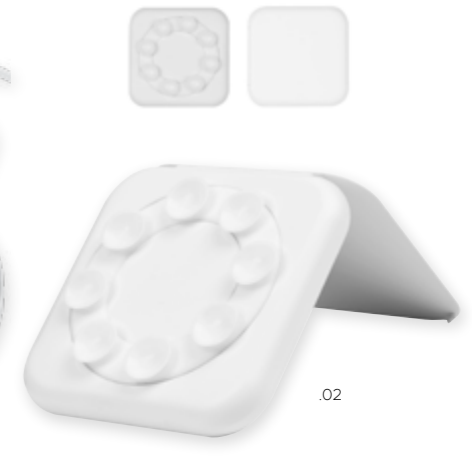

26294
Aston

Caricatore wireless e supporto telefono 2 in 1. Un lato caricatore wireless, secondo lato supporto telefono. Include cavo di ricarica. | Wireless charger and mobile holder 2 in 1. One side wireless charger, other side phone holder. Includes charging cable.

Abs | Abs

☐ 6,2 x 6,2 x 1,3 cm





.43



26559
Tenessinio



Base di ricarica wireless con un lato in tessuto RPET. Basterà appoggiare il vostro dispositivo per avviare la ricarica. Compatibile con modelli con tecnologia wireless. Fornito con cavo micro usb. | Wireless charging base with one side in RPET fabric. Compatible with models with wireless charging.

Abs riciclato, RPET | Recycled abs, RPET

□□□□ □ 10 x 0,7 cm



.43



26558
Tellurio



Powerbank wireless con un lato in tessuto RPET. Uscita USB 5V/2.1A. Fornito con cavo micro usb. Indicatore di ricarica led. | Powerbank with one side in RPET fabric. Charging led indicator. Micro USB cable included.

Abs riciclato, RPET | Recycled abs, RPET

□□□□ □ 6,7 x 12 x 12,6 cm



.02



26557
Tecnezio



Speaker bluetooth con profilo con luce led. Bluetooth 5.0. Potenza 3W. Batteria ricaricabile con cavo incluso. | Bluetooth speaker with led light profile. Bluetooth 5.0. 3W power.

Abs riciclato | Recycled abs

□□□□ □ 6,2 x 6,5 cm



.03



26556
Tau



Speaker bluetooth wireless. Corpo in tessuto RPET e membrana a vista. Bluetooth 5.0. Potenza 3W. Batteria ricaricabile. Cavo incluso. | Wireless bluetooth 5.0 speaker. Woven RPET body and exposed membrane. 3W power.

Abs riciclato, RPET | Recycled abs, RPET

□□□□ □ 7,9 x 4,6 cm



RECYCLED ABS



I principali vantaggi della plastica ABS sono il suo punto di fusione relativamente basso e la sua temperatura di transizione vetrosa, che ne facilitano la fusione e l'utilizzo nello stampaggio a iniezione. Grazie a questo, è considerato un materiale molto versatile e perfetto per un gran numero di applicazioni.

Quando parliamo di RABS, ci riferiamo a un materiale riciclato post-consumo. È caratterizzato da approvvigionamento sostenibile e bassa impronta di carbonio.

ABS plastic main advantages are its relatively low melting point and its glass transition temperature, which makes it easy to melt down and use in injection moulding. Thanks to this, it is considered a very versatile material and perfect for a great number of applications.

When we talk about RABS, we refer to a post-consumer recycled material. It is characterized by sustainable procurement and low carbon footprint.



26593
Merlara

Caricatore wireless con carica rapida da 10 W. Connettore di tipo C. Cavo incluso. | Wireless charger with 10W fast charge. Type-C connector. Cable included.

Abs riciclato, sughero naturale | Recycled abs, natural cork

10,4 x 2,1 cm



WIRELESS CHARGING

CORK



26578
Schio

HUB usb con corpo in bambù e tessuto RPET. 2 porte USB e USB tipo C integrate. | USB HUB with body in bamboo and RPET fabric. Built-in 2 USB and USB Type-C ports.

Bamboo, RPET | Bamboo, RPET

8,2 x 1,2 cm



26580
Valeggio

Caricatore wireless compatibile con i dispositivi dotati di tecnologia wireless. Uscita 10W. Connettore di tipo C. Cavo incluso. | Wireless charger compatible with devices equipped with wireless technology. 10W output. Type-C connector. Cable included.

Bamboo, RPET | Bamboo, RPET

0,8 x 9,8 cm



26594
Morgano

Sveglia con modalità luce mattutina. 12 luci LED con funzione di lampada. Cavo incluso. | Alarm clock in recycled ABS and cork. 12 LED lights with lamp function. Cable included.

Sughero, Abs riciclato | Cork, recycled Abs

18,5 x 14,4 x 6,6 cm



26579
Teolo

Speaker wireless con corpo. Uscita da 3W e batteria ricaricabile. Connessione di tipo C. Cavo incluso. | Wireless speaker with body. 3W output and rechargeable battery. Type C connection. Cable included.

Bamboo, RPET | Bamboo, RPET

5,3 x 6 cm



BAMBOO

RPET FABRIC

BAMBOO WOOD
RECYCLED PLASTIC

RPET FABRIC

BAMBOO

BAMBOO WOOD
RECYCLED PLASTIC

BAMBOO WOOD
RECYCLED PLASTIC



WIRELESS SPEAKER IN RPET

Speaker with bamboo details. 3W output. Type C connection.



.00



BAMBOO



26581
Pincara



Speaker wireless. Uscita da 3W e batteria ricaricabile. Connessione di tipo C. Cavo incluso. | wireless speakers. 3W output and rechargeable battery. Type C connection. Cable included.

Bamboo, RPET | Bamboo, RPET

9,5 x 9,5 cm



WIRELESS SPEAKER IN RPET

Speaker in RPET fabric. 3W output. Type C connection.



.03

RPET FABRIC



26586
Tregnago



Speaker wireless con caricatore wireless integrato da 5W. Uscita 3W. Connessione di tipo C. Cavo incluso. | Wireless speaker with built-in 5W wireless charger. 3W output. Type C connection. Cable included.

RPET | RPET

8 x 9,3 cm



WIRELESS CHARGING



RECYCLED PLASTIC

SET OF USB CHARGERS

Chargers for car and wall. In fun colours.



26123
Wezen

Set di caricatori USB da auto e da parete. Capacità di ricarica 1000mAh, con indicatore di ricarica. Fornito in resistente custodia | Set of USB chargers for car and wall. 1.000 mAh charging capacity and in fun colours. , with charging indicators and presented in a bold and resistant case.

Plastica | Plastic

6 x 3,5 x 7,5 cm



26286
Hamina

Cavo di ricarica 3 in 1, con connettore Type-c, microusb e lightning. | USB charger cable 3 in 1, with Type-C, micro USB and Lightning connections.

Metallo, Tessuto | Metal, Fabric

15 cm



26339
Derby

Cavo di ricarica USB con connettore microusb. Lunghezza 1 mt. Fornito in pouch | Cable to charge devices with USB input and connection for micro USB input. 1 meter length. Presented in a single pouch with drawstring.

Nylon, Rame | Nylon, Copper

Pouch: 8,5 x 14 cm - Cable: 1 m



26081
Elly

Caricatore USB per accendisigari della macchina. Capacità di ricarica 1000mAh. Indicatore di ricarica led. | USB charger for car cigarette lighter. 1.000 mAh charging capacity, with LED charge indicator.

Plastica | Plastic

5,4 x Ø 2,3 cm



26122
Placidus

Caricatore USB per accendisigari della macchina. Capacità di ricarica 2100mAh. Doppia porta USB. Finitura semitrasparente con indicatore led. | USB charger for car lighter. 2.100 mAh charging capacity in bold bicolour design. With dual USB output. Translucent cover with LED indicator.

Plastica | Plastic

2,6 x 3,7 x 8 cm



26396
Carnelian

Portachiavi con caricatore da auto con una uscita USB. | Keyring with car charger with one usb output.

Plastica | Plastic

5 x 2,5 x 1,5 cm



29296
Barinas

Cavetto adattatore 2 in 1 autoavvolgente. Connettore micro USB/lightning e tipo C | Charger cable with retractile mechanism. 2 in 1 Micro USB and lightning and type-c connection

Plastica | Plastic

4,5 x 4 x 1,7 cm



26293
Barile

Portachiavi caricatore, con cavo tipo C, micro USB e standard USB | USB charging cable with key ring. Includes standard USB, type C and micro USB.

Plastica | Plastic

18,8 x 2,8 x 1,5 cm



26278
Myrte

Portachiavi caricatore USB, con doppio connettore microusb/lightning | USB keychain charger. With dual micro USB/lightning connection.

Plastica | Plastic

1,3 x 5,2 x 1,3 cm





 **26393**
Goro
Splitter per dispositivi mobili. 5 ingressi jack. | Splitter for mobile devices. 5 jack input.
Plastica | Plastic
4,5 x 6,5 cm



 **85086**
Gaby
Flash aggiuntivo per dispositivi mobili. Luce con 16 led. | Additional flash light for mobile devices and tablets. It has 16 led light.
Plastica | Plastic
4 x 4 cm
  



 **85038**
Shelkovo
Luce 6 led con braccio flessibile, alimentata con USB. | 6 LED lamp with flexible arm and USB power supply.
Plastica | Plastic
1,8 x 16,8 x 1 cm
   



 **26428**
Assino   
Hub usb realizzato con 4 porte USB integrate. Fornito in confezione dal design eco. | USB hub made with 4 integrated USB ports. Supplied in eco design packaging.
Fibra di grano | Wheat fiber
1,8 x Ø 5,2 cm
 



 **26582**
Refrontolo  
Portachiavi con cavo di ricarica 3 in 1. Micro USB, Tipo C e connessione lightning. | Keychain with 3 in 1 charging cable. Micro USB, Type C and lightning connection.
Bamboo | bamboo
4 x 10 cm
  







 **26193**
Yantarny
Hub usb dal design bicolore. Dotato di 4 porte USB 2.0. | Bicolour design USB hub with an elegant aluminium finish. With 4 USB 2.0 ports.
Alluminio | Aluminum
9 x 4 x 2,5 cm
   



 **26471**
Wanda 
Cavo di ricarica 3 in 1, con dettagli in bambù. Connettori tipo C, micro USB/Lightning e USB. | 3 in 1 charger cable, with details in bamboo. Type-C, dual micro USB / Lightning and USB connections.
Plastica, Bamboo | Plastic, Bamboo
16,5 x 2,1 x 1 cm
  



 **26381**
Foro 
Hub con 3 porte USB 2.0. Fornito in confezione avana | Bamboo hub with 3 USB ports 2.0. Presented in and individual kraft box.
Bamboo | bamboo
8 x 1,5 x 4 cm
  

BLUETOOTH 5.0 SPEAKER

Fabric finish.
Transparent membrane with
6 LED light modes.
Equipped with
a durable handle.



26572
Alonte

NEW

Speaker bluetooth 5.0 con finitura in tessuto. Membrana trasparente con 6 modalità di luce LED. Potenza 10W. Dotato di resistente manico e placchetta speciale per la personalizzazione. Batteria di lunga durata. | Bluetooth 5.0 speaker with fabric finish. Transparent membrane with 6 LED light modes. Power 10W. Equipped with a durable handle and special plate for personalization. Long battery life.

Plastica, Tessuto | Plastic, Fabric

18,5 x Ø7,50 cm



POWER 10W

FABRIC FINISH

.01

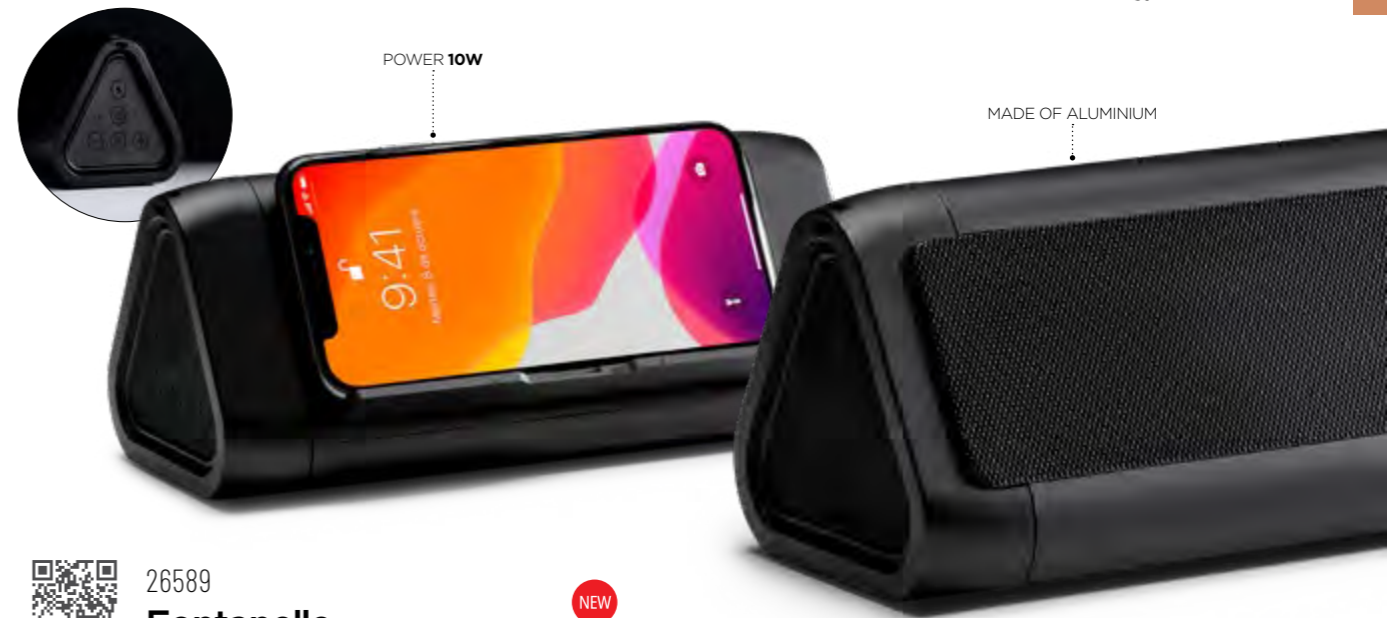

POWER 10W

MADE OF ALUMINIUM



26589
Fontelle

NEW

Speaker wireless in alluminio. Uscita 10W. Connessione di tipo C. Cavo incluso. Fornito in confezione singola dal design eco. | Aluminum wireless speaker. 10W output. Type C connection. Cable included. Supplied in eco-designed single pack.

Alluminio | Aluminum

19,9 x 8,5 cm



.01



.40

.01

.85



.88



26497
Gallo

Speaker wireless bicolore Bluetooth. Opaco effetto gommato. Potenza 3W. Batteria ricaricabile. Cavo incluso. | Bicolor Bluetooth wireless speaker. Body in matt rubber touch finishing. Power 3W. Cable included.

Plastica | Plastic

11,1 x 4,1 x 8,3 cm



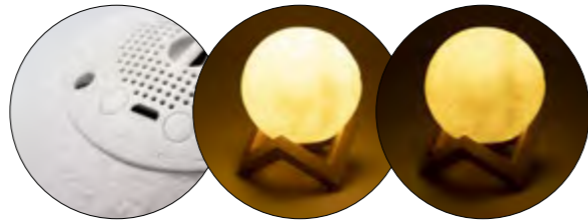

30028
Arente

NEW

Lampada speaker dal design lunare dotata di base in legno. Potenza 3W. Luce LED con diverse modalità. Cavo incluso. | Speaker lamp with a lunar design equipped with a wooden base. Power 3W. LED light with different modes. Cable included.

Legno, plastica | Wood, plastic

12 x 15 x 12 cm



4 LIGHT MODES



26383
Freganzorzi

NEW

Speaker wireless bluetooth 5.0 realizzato in bambù con LED multicolore con 4 modalità di luce. Potenza 3W. Batteria ricaricabile e cavo incluso. | Bluetooth 5.0 wireless speaker made of bamboo with multicolored LED with 4 light modes. Power 3W. Rechargeable battery and cable included.

Bamboo | bamboo

10,6 x Ø 6,4 cm



26570
Alpago

NEW

Speaker bluetooth 5.0, con corpo in bambù e ABS, con elegante laccettino per il trasporto. Potenza 3W. Batteria ricaricabile. Cavo di ricarica incluso. | Bluetooth 5.0 speaker, with bamboo and ABS body, with elegant carrying strap. Power 3W. Rechargeable battery. Charging cable included.

Bamboo, Abs | Bamboo, abs

8,1 x Ø 6,9 cm



.03



26317
Folletto

NEW

Speaker Bluetooth con corpo in cemento calcareo e superficie in bambù naturale. 5 W di potenza e caricabatterie wireless. | Bluetooth speaker with rectangular body in cement and top surface in natural bamboo. 5W output.

Cemento calcareo, Bamboo | Limestone cement, Bamboo

11,8 x 7,8 x 6,5 cm

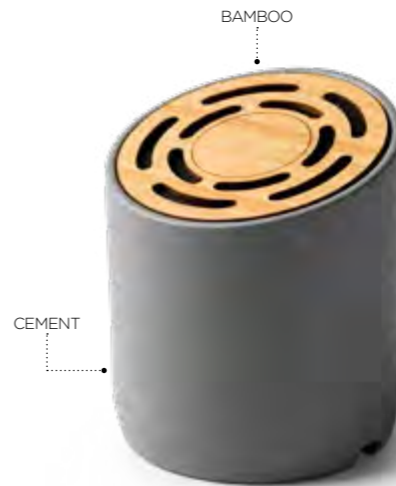

.03



26315
Flappy

NEW

Speaker wireless Bluetooth 5.0 con corpo in cemento calcareo e superficie in bambù naturale. Potenza 3 W e batteria ricaricabile. Cavo di ricarica incluso. | Wireless 5.0 Bluetooth speaker with round body in cement and top surface in natural bamboo. 3W output. Charging cable included.

Cemento calcareo, Bamboo | Limestone cement, Bamboo

Ø 7 x 7,2 cm



SPEAKER AND CHARGER

Round body made in cement and top surface in natural bamboo.

SPEAKER AND CHARGER

Made recycled cardboard and bamboo



30040
Quero



Speaker wireless. Potenza 3W. Autonomia di riproduzione 2h. Alimentato con cavo type C incluso (lunghezza 50cm) | wireless speakers. Power 3W. Playback autonomy 2h. Powered with included type C cable (50cm length)

Cartoncino FSC, Bamboo FSC | FSC cardboard, FSC bamboo
[] 6,5 x 6,5 x 8,6 cm



30036
Pieve



Speaker wireless con caricatore wireless integrato da 10W, potenza speaker 5W. Alimentato con cavo type C incluso (lunghezza 50cm). | Wireless speaker with built-in 10W wireless charger, 5W speaker power. Powered with included type C cable (50cm length).

Cartoncino FSC, Bamboo FSC | FSC cardboard, FSC bamboo
[] 10,7 x 7 x 7,1 cm



26306
Fido



Speaker wireless Bluetooth con corpo in ABS e frontale in bambù naturale. Include maniglia di trasporto in similpelle. Potenza 3 W. Cavo incluso. | Wireless Bluetooth speaker with ABS body, natural bamboo front. Handle in imitation leather included. 3W output. Cable included.

Abs, Bamboo, Similpelle | Abs, Bamboo, Leatherette
[] 7,4 x 7 x 4,5 cm



26505
Gentile



Speaker wireless con corpo in legno. Bluetooth 3.0. Potenza 3W. Batteria ricaricabile. Cavo incluso. | Wireless speaker with wooden body. Bluetooth 3.0. Power 3W. Cable included.

Legno | Wood
[] 6 x 6 x 6 cm



30034
Zolfo



Speaker bluetooth wireless. | Wireless Bluetooth speaker

Bamboo | bamboo
[] Ø 6 x 5 cm



30035
Chongqing



Speaker bluetooth 5.0 realizzato. Pulsanti di controllo integrati nella base. Funzione radio e ricezione chiamate. Potenza 3W. Inserto led luminoso. Ricaricabile con cavo microusb incluso. | Bluetooth 5.0 speaker. Control buttons integrated in the base. Radio function and call reception. Power 3W. Luminous led insert. Rechargeable with microusb cable included.

Bamboo | bamboo
[] 6 x 6 cm



30268
Zeri



Speaker bluetooth. Potenza 3W. Ricaricabile con cavo usb incluso. | Compact speaker in bamboo. Bluetooth* connectivity and 3W.

Bamboo | bamboo
[] Ø 7,3 x 4,2 cm





30037
Noale



Mini speaker wireless. Potenza 3W. Portata di trasmissione 10m. Ingresso DC5V. Fornito con cavo di ricarica. | Mini wireless speakers. Power 3W. Transmission range 10m. DCSV input. Supplied with charging cable.

Bamboo FSC | Bamboo FSC

9 x 6 x 2 cm



.00

WHEAT FIBER
NATURAL CORK



.11



26566
Pechino



Speaker bluetooth 5.0. Pulsanti di controllo integrati nella base. Grazie al led interno dopo l'incisione il logo si illumina Potenza 3W. Ricaricabile con cavo microusb incluso. | Bluetooth 5.0 speaker. Control buttons integrated in the base. Thanks to the internal LED after engraving the logo lights up. Power 3W. Rechargeable with microusb cable included.

Sughero, fibra di grano | Cork, wheat fiber

6 x 6 x 5,1 cm



NATURAL CORK



.00



26526
Abelia



Speaker con membrana a vista. Bluetooth 5.0. Potenza 3W. Batteria ricaricabile. Cavo incluso. | Speaker with visible cone. 5.0 Bluetooth. 3W output. Rechargeable battery. Cable included.

Sughero | Cork

4,6 x Ø 7,9 cm



WHEAT FIBER



.13



30026
Antelao



Speaker wireless bluetooth 5.0. Potenza 3W. Cavo incluso. | Bluetooth 5.0 wireless speaker. Power 3W. Cable included.

Fibra di grano, Abs | Wheat Fiber, Abs

4,5 x Ø 7,4 cm



WHEAT FIBER



.13



30024
Allai



Speaker con caricatore wireless integrato con tecnologia di ricarica veloce da 10W. Connessione bluetooth 5.0. Potenza 5W. Ricaricabile con cavo USB incluso. | Speaker with built-in wireless charger with 10W fast charging technology. Bluetooth connection 5.0. 5W power. Rechargeable via USB cable included.

Fibra di grano, Abs, Bamboo | Wheat Fiber, Abs, Bamboo

16 x 5,9 x 6 cm





26365
Barolo

Speaker a forma di microfono. Connessione bluetooth 4.1. Portata massima 10 metri. Potenza 3W. Microfono integrato per funzione vivavoce. | Speaker shaped as a microphone. Bluetooth version 4.1. Operation range up to 10 meters. Power 3 W. Built-in microphone for hands-free phone call.

Plastica | Plastic

8,5 x 16,5 cm

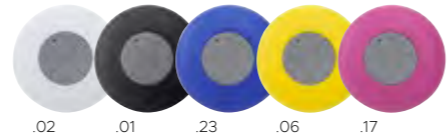

26400
Ghedi

Speaker bluetooth resistente all'acqua. Connessione Bluetooth, potenza 3W, funzione viva-voce, ventosa in silicone alla base. | Bluetooth* connectivity speaker. Water splash resistant. With Bluetooth* 3.0 connection, it delivers 3W of power, has hands-free function and includes a silicone suction cup at the base.

Abs | Abs

Ø 8,4 x 5 cm



26496
Galilea

Speaker wireless Bluetooth 5.0 rifinitura bianco in gomma. Pannello di controllo tattile e luce LED multicolore Potenza 3W. Batteria ricaricabile. Cavo incluso. | Wireless Bluetooth 5.0 speaker in white finish with rubber touch. Touch control panel and multicolored LED light Power 3W. Cable included.

Plastica | Plastic

Ø 7,1 cm



26190
Sherpi

Speaker. Connessione bluetooth, potenza 3W, funzione vivavoce, alloggiamento per mini SD card fino a 32GB, ingresso jack da 3,5mm. Include cavo di ricarica mini USB, cavo con jack da 3,5mm. | Speaker with bluetooth* 3.0 connection, it delivers 3W of power, has hands-free function, a slot for mini SD cards up to 32 GB and auxiliary line input via jack 3,5mm, includes mini USB cable

Plastica | Plastic

7,5 x Ø 6 cm



26183
Alvdal

Speaker ad induzione. Funziona appoggiando lo smartphone sulla superficie e ascoltando il suono che viene amplificato. | Induction speaker. Simply place your mobile phone on the flat surface and listen to the amplified sound. No wireless settings or cables needed.

Plastica | Plastic

12,5 x 3,8 x 6,8 cm



30004
Damasco

Speaker bluetooth. Connessione Bluetooth, potenza 3W, funzione vivavoce, slot per schede mini SD fino a 64 GB di capacità, funzione radio FM. | Compact Bluetooth* connectivity speaker. Bluetooth* 3.0 connection, it delivers 3W of power, has hands-free function, a slot for mini SD cards up to 64 GB of capacity, FM radio function.

Metallo | Metal

Ø 5,9 x 5 cm

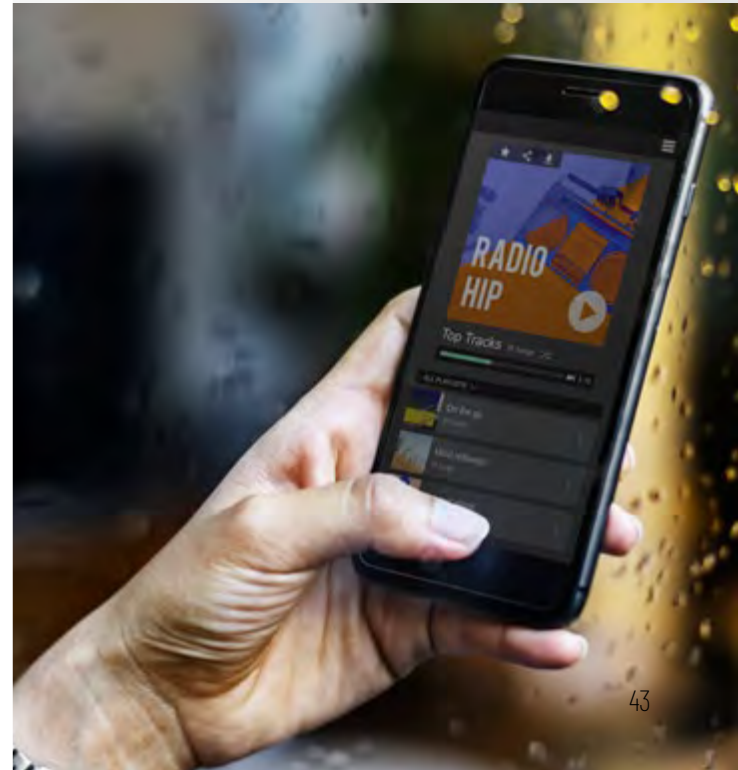



WHEAT FIBER

.13



26473
Coda



Auricolari con connessione Bluetooth® 5.0 realizzati in fibra di grano. Pannello di controllo touch integrato sull'auricolare, base di ricarica coordinata con LED. | Earphones with Bluetooth® 5.0 connection in wheat straw, including an integrated, touch control panel in the earphone, with matching colour charging base and LED light for charging status.

Fibra di grano, Abs | Wheat Fiber, Abs

▮▮▮▮▮ 4,5 x 6,8 x 2,2 cm



WHEAT FIBER

.13



26585
Torre



Auricolari wireless con custodia di ricarica. Pannello di controllo integrato con tecnologia touch. Batteria ricaricabile. Cavo di tipo C incluso. | Wireless earphones with charging case. Integrated control panel with touch technology. Rechargeable battery. Type-C cable included.

Fibra di grano, Abs, Bamboo | Wheat Fiber, Abs, Bamboo

▮▮▮▮▮ 3,9 x 2,3 x 3,7 cm



.11



26483
Yoko



Auricolari bluetooth 5.0 con custodia in bambù. Potenza 3mW. Raggio di portata 10m. | Bluetooth 5.0 wireless headsets presented in a bamboo box. Autonomy of approximately 2 hours. Power 3mW. Range 10 meters.

Bambù, Abs | Bamboo, abs

▮▮▮▮▮ 7,8 x 3,2 x 3,2 cm



RECYCLED ABS

CORK

.02



26591
Jesolo



Auricolari wireless. Custodia di ricarica con batteria ricaricabile. Pannello di controllo touch integrato nell'auricolare. Connessione di tipo C. Cavo incluso. | Wireless earphones. Charging case with rechargeable battery. Touch control panel integrated into the headset. Type C connection. Cable included.

Sughero, Abs riciclato | Cork, recycled Abs

▮▮▮▮▮ 6,7 x 5 x 3 cm



BAMBOO

RECYCLED ABS

.02



26553
Tanacetum



Auricolari bluetooth dotati di custodia di ricarica con inserto in legno. Indicatore led di ricarica. Portata del bluetooth fino a 10mt. | Bluetooth earphones with charging case with wooden insert.

Abs riciclato, Bambù | Recycled Abs, Bamboo

▮▮▮▮▮ 6,5 x 2,6 x 3,6 cm



WIRELESS NOISE-CANCELLING EARBUDS

In-built control panel with touch technology. Hands-free function.



26584
Sossano

NEW

Auricolari wireless con tecnologia di cancellazione del rumore. Pannello di controllo integrato con tecnologia touch. Custodia di ricarica con batteria ricaricabile e indicatore di ricarica. Connessione di tipo C. | Wireless earphones with noise canceling technology. Integrated control panel with touch technology. Charging case with rechargeable battery and charging indicator. Type-C Connection

Plastica | Plastic

5,9 x 5,3 cm



.02



.02



26492
Vicky

Auricolare Bluetooth 5.0 con custodia di ricarica. Indicatore di carica a LED sulla custodia e pulsante multifunzione integrato. Cavo incluso | Bluetooth 5.0 wireless headsets with charging case. Autonomy of approximately 3-4 hours. Cable included

Plastica | Plastic

6,2 x 2,8 x 4 cm



.02



26542
Celastro

NEW

Auricolari bluetooth con indicatore di ricarica. Forniti con custodia di ricarica, ricaricabile tramite micro USB. Ampia superficie di stampa sulla custodia. | Bluetooth earphones with numerical charge indicator. Supplied in a charging case, rechargeable via micro USB. Large printing area on the case.

Abs | Abs

5,5 x 2,5 x 5 cm



.02



26462
Whoopi



Auricolari antibatterici con elegante finitura bianca e connessione Bluetooth® 5.0. Realizzati in ABS lucido e dal design ergonomico, includono un pulsante touch control integrato nell'auricolare, con base di ricarica coordinata. | Antibacterial earphones with Bluetooth® 5.0 connection in an elegant white colour design in glossy finish. Including an integrated, touch control button in the earphone, with matching colour charging base. Micro USB cable included.

Plastica | Plastic

4,5 x 6,8 x 2,2 cm



.02



26441
Bure

Auricolari con connessione bluetooth 5.0. Controllo touch sensitive. Forniti in custodia di ricarica. Ricaricabile con cavo USB incluso. | Earphones with bluetooth connection 5.0. Touch sensitive buttons. Presented in an individual charging case. Rechargeable with USB cable included.

Plastica | Plastic

4,5 x 6,8 x 2,2 cm





.02



26307
Figaro

Auricolari magnetici con connessione bluetooth, autonomia di circa 1,5 ore. Portata massima 10 metri. Forniti in confezione singola. | Magnetic earphones with bluetooth connection 4.1, with autonomy of 1 hour and a half approximately. It has a magnet on the back of the earphones to join them. Scope 10 meters. Power 5mw.

Metallo, Abs | Metal, Abs

7,5 x 3,2 x 3,2 cm



.02



26990
Anekoski

Auricolari bluetooth. Base di ricarica con indicatore di carica led e coperchio. Ricaricabile tramite cavo USB incluso. | Earphones with Bluetooth® connectivity. Charging base with led light charging indicators and lid. Rechargeable via USB cable -included-

Abs | Abs

5,5 x 3 x 6,5 cm



.01

.02



26086
Hanna

Auricolari retraibili con attacco con jack da 3,5mm | Retractable earphones with 3,5mm jack input.

Plastica | Plastic

2,5 x 3,8 x 1,1 cm



.02



26397
Diaspore

Auricolari con connessione con jack da 3.5mm. Con custodia in plastica supporto per cellulare integrato. | Earphone with 3.5mm jack connection. With plastic box with phone holder integrated.

Plastica | Plastic

Ø 6,8 cm



.01

.02



26995
akaa

Auricolari con connessione bluetooth. Design ergonomico, pulsanti di controllo integrati nel cavo. Ricaricabile con cavo mini usb incluso. | Earphones with bluetooth connection. Ergonomically designed, including an integrated control panel in the cable. Rechargeable via mini USB cable -included-

Custodia in similpelle | Leatherette case

Ø 8 x 3,9 cm



.02

WIRELESS EARBUDS

In-built control panel with touch technology. Hands-free function



26583
Salizzole

NEW

Auricolari wireless con custodia di ricarica. Pannello di controllo integrato con tecnologia touch. Batteria ricaricabile con connessione di tipo C. Cavo incluso. | Wireless earphones with charging case. Integrated control panel with touch technology. Rechargeable battery with type C connection. Cable included.

Plastica | Plastic

4,6 x 4,6 cm



.47

.46

.44

.01

.02

.23



.02

.06

.08

.17

.05

.01

.04

.07



.02

.05

.08



.08



26522
Jim

Auricolari con connessione con jack da 3,5mm, cavo coordinato. Fornito in custodia di plastica trasparente, con gommini di ricambio | Earphones with a bicolored design, 3.5mm jack connection and matching colour cable. Presented in an elegant design case and with spare pads.

Plastica | Plastic

7 x 7 x 2 cm



26197
Vytegra

Auricolari pratici e confortevoli, con jack da 3,5mm, cavo coordinato. Fornito in bustina in PVC con chiusura. | Practical and comfortable earphones, with 3,5 mm jack connection and matching color cable. Presented in transparent PVC bag with self-closure.

Plastica | Plastic

8 x 7,8 x 1,2 cm



26230
Dunham

Auricolari in plastica con jack da 3,5mm. | Earphones with 3,5 mm audio Jack connection

Plastica | Plastic

5,5 x 5,8 x 2,1 cm



ADJUSTABLE WIRELESS HEADPHONES

Made of bamboo and RPET fabric. Padded headband and ear pads.



26587
Zimella



Cuffie wireless. Archetto regolabile imbottito. Padiglioni imbottiti. Controllo touch integrato con tecnologia stereo. Batteria ricaricabile. Cavo di tipo C incluso. | Wireless headphones. Padded adjustable headband. Padded earpads. Integrated touch control with stereo technology. Rechargeable battery. Type-C cable included.

Bamboo, RPET | Bamboo, RPET

12,5 x 18 cm



MADE OF RPET



MADE OF BAMBOO

.11

WHEAT FIBER



.13



26571
Allegha



Cuffie wireless. Archetto e padiglioni imbottiti. Pieghevoli. Pannello per il controllo integrato con tecnologia stereo. Funzione radio FM. Batteria ricaricabile. Cavo incluso. | Wireless headphones. Padded headband and earcups. Foldable. Integrated control panel with stereo technology. FM radio function. Rechargeable battery. Cable included.

Fibra di grano | Wheat fiber

17 x 7,5 x 18,5 cm



WHEAT FIBER



.02

.05

.01



.01



26517
Kiara

Cuffie wireless Bluetooth 5.0 con rifinitura in gomma. Pieghevoli. Imbottitura ecopelle. Lateralini in alluminio. Pannello di controllo integrato con tecnologia stereo. Radio FM. Cavo incluso. | Bluetooth 5.0 wireless headphones with rubber touch finish. Foldable. Upper padding and soft leatherette ear pads. Aluminium sides. Integrated control panel with stereo technology. Cable included.

Finitura gommata; imbottitura superiore e cuscinetti in morbida similpelle | Rubberized finish; upper padding and cushions in soft leatherette

19 x 7,7 x 18,5 cm



26518
Kie

Cuffie wireless Bluetooth 5.0 con pannello di controllo integrato e tecnologia stereo. Pieghevoli. Comodi cuscinetti in ecopelle. Cavo incluso. | Bluetooth 5.0 wireless headphones with integrated control panel and stereo technology. Foldable. Comfortable leatherette ear pads. Cable included.

Plastica | Plastic

19 x 8 x 17,5 cm



.08



.02



49131

Rivamonte

NEW

Allarme personale, attivabile separando il connettore collegato al portachiavi. | Personal alarm, which can be activated by separating the connector connected to the key ring.

Plastica | Plastic

3,9 x 6,1 cm



26219

Tanzanite

Visore per realtà virtuale con lenti regolabili e alloggiamento per smartphone. Connettore jack da 3.5mm. | Virtual Reality glasses with adjustable lenses and tray for all types of smartphones. 3.5mm audio.

Abs | Abs

14 x 12,9 x 20 cm



.02

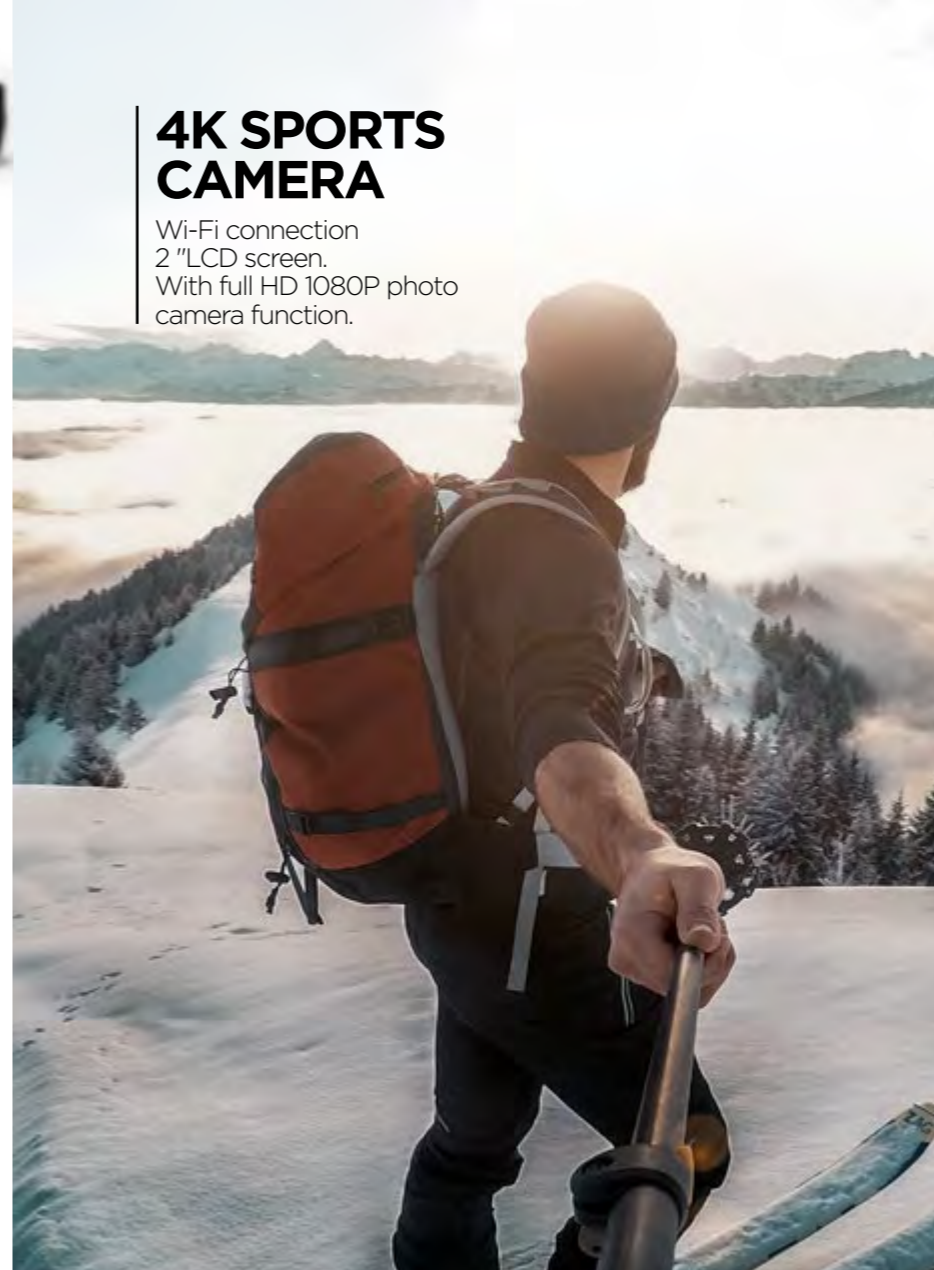

4K SPORTS CAMERA

Wi-Fi connection
2" LCD screen.
With full HD 1080P photo camera function.



.01



26516

Krende

Fotocamera sportiva con tecnologia video HD 4K e connessione Wi-Fi. Schermo LCD 2". Risoluzione foto Full HD 1080P. Include custodia resistente all'acqua e vari accessori di collegamento multifunzione. Cavo incluso. | Sports camera with 4K HD video technology and Wi-Fi connection. 2" LCD screen. With full HD 1080P photo camera function. Includes rugged submersible case. Cable included.

Plastica | Plastic

3 x 4,2 x 6 cm



4K





.01



26551
Tamaro

Supporto auto per smartphone con caricatore wireless. Collega il dispositivo, posiziona il cellulare su di esso e lascialo caricare. Cavo incluso. | Smartphone holder with wireless car charger. Plug in your device, place your phone on it and let it charge. Cable included.

Metallo | Metal

☐ 6,4 cm

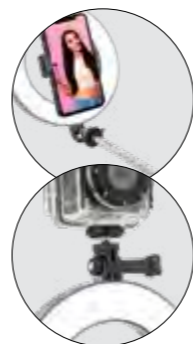

.01



26574
Anguillara

NEW

Treppiede da viaggio per influencer. Con anello luminoso diffusore per illuminare il viso in selfie e video. 3 modalità di luce (fredda, mista e calda) e 2 intensità regolabili. Funzione treppiede e selfie stick. | Influencer travel tripod With diffuser light ring to illuminate the face in selfies and videos. 3 light modes (cold, mixed and warm) and 2 adjustable intensities. Tripod and selfie stick function.

Abs, Alluminio | Abs, Aluminum

☐ 40cm



3 LIGHT MODES

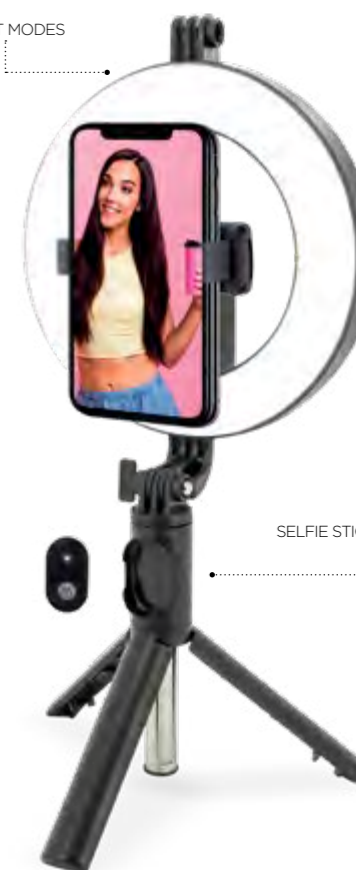

SELFIE STICK FUNCTION



.02

.01



29242
Rancher

Supporto per smartphone. Sistema di fissaggio alle prese d'aria della macchina. | Holder for smartphone. With fixing system for car ventilation grille

Abs | Abs

☐ 5 x 9,7 x 2,8 cm



.01

.00



26254
Lattjo

Supporto magnetico per smartphone. Sistema di fissaggio alle prese d'aria della macchina. | Magnetic holder for smartphone. With fixing system for car ventilation grille.

Alluminio | Aluminum

☐ 3 x 0 3,3 cm



3 LIGHT MODES

.01



26575
Angiari

NEW

Treppiede per influencer. Pratico treppiede con anello luminoso integrato per illuminare professionalmente il tuo viso. Con intensità regolabile nelle sue 3 modalità di luce (calda, fredda e mista). Ha un giunto a sfera regolabile per adattare l'angolo id | Influencer tripod Handy tripod with integrated light ring to professionally illuminate your face. With adjustable intensity in its 3 light modes (warm, cold and mixed). It has an adjustable ball joint to adjust the ideal angle in your shooting.

Abs, Alluminio | Abs, Aluminum

☐ 26cm



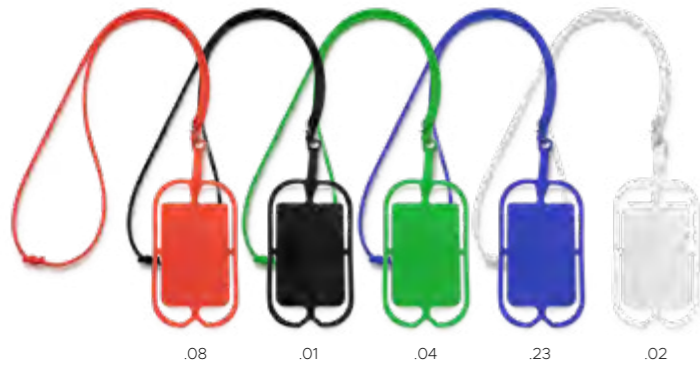

.08 .01 .04 .23 .02



41141
Padova

NEW

Lanyard con funzione porta cellulare e porta carte di credito, sistema di regolazione. Dotato di moschettone. | Lanyard with mobile phone and credit card holder function, adjustment system. Equipped with carabiner.

Silicone | Silicone

58 cm



.02 .01 .08 .03 .23



26870
Barguzin



Oscurante per fotocamera, adesivo 3M riutilizzabile. | Cover for mobile device camera, with 3M reusable adhesive.

Plastica | Plastic

3,2 x 1,3 cm



.32



.32

.31

.01



.02



.02



85059
Ningbo

Lampada da scrivania con portapenne integrato con funzione di supporto telefono. Con potente LED. Rotazione fino a 180°. Alimentata con cavo USB incluso. | Desk lamp with integrated pen holder with telephone holder function. With powerful LED. Powered with included USB cable.

Plastica | Plastic

9 x 27 cm



26264
Falterona

Supporto per cellulare | Mobile Support

Metallo | Metal

3,5 x 3 cm



26993
Föglö

Supporto per smartphone. Con anellino telescopico doppia funzione: supporto per telefono e accessorio per selfie. | Sticky holder with telescopic rear finger ring with double function: as a holder and as an accessory for selfies.

Plastica | Plastic

3,5 x 4 x 0,6 cm



26373
Harry

Supporto scorrevole adesivo per smartphone | Slider adhesive holder for mobile devices.

Abs | Abs

8 x 2,5 x 0,4 cm





WHEAT FIBER



41133
Biscotto



Supporto per smartphone realizzato in fibra di grano/PP. Piedini pieghevoli in PVC antiscivolo. | Holder for mobile device of nature line. Made of wheat straw/PP. Folding legs with non-slip PVC stops.

Fibra di grano, PP | Wheat fiber, PP

8,5 x 3 x 8,5 cm



HOLDER FOR MOBILE

With folding legs and with non-slip stops.



29183
Adhara

Supporto per dispositivi mobili, pieghevole con inserti antiscivolo. | Holder for mobile device with folding legs and with non-slip stops.

Plastica | Plastic

8,5 x 3 x 8,5 cm



30020
Ried

Bastone per selfie pieghevole, sistema antirotazione e manico soft touch con finitura in gomma. | Foldable selfie stick with stainless steel pole, anti-rotation system and soft handle with rubber finish. Carrying belt.

Plastica | Plastic

116,5 x Ø 1,8 cm



26445
Casternone

Supporto adesivo pieghevole per smartphone, con adesivo alla base. | Foldable adhesive phone holder, with adhesive pad on the base. Compact size when folded. Large printing area.

Plastica | Plastic

Ø 4 x 3 cm



26100
Elsa

Puliscischiermo. | Screen cleaner.

Plastica | Plastic

8 x 7 x 2 cm



26078
Elvy

Puntatore touchscreen con puliscischiermo. | Touchscreen pointer with screen cleaner.

Plastica | Plastic

6,2 x 3 x 1,2 cm



26224
Kamenka

Set di 3 lenti per smartphone, adattabile alla fotocamera grazie alla clip. Lenti in vetro e alluminio, fish-eye, macro e grandangolo. Fornito in pouch. | Set of 3 universal lenses for smartphone, adjustable to the camera by means of a clip. Aluminium and glass lenses, with -fish-eye-, -macro- and -wide angle- effects. Presented in a velvet bag with self-closing laces.

Acciaio Inossidabile | Stainless steel

9,5 x 13,7 x 2,5 cm





.11



26560
Mufasa

Supporto per smartphone e tablet, in bambù. Un lato adatto ai tablet e uno per gli smartphone. | Mobile and tablet holder made of bamboo. One side suitable for smartphone and the other side for tablet.

Legno di pino | Pine wood

10 x 6 x 2 x 8 cm



.11



26488
Yoli

Supporto per smartphone e tablet, in bambù. Un lato adatto ai tablet e uno per gli smartphone. | Mobile and tablet holder made of bamboo. One side suitable for smartphone and the other side for tablet.

Bamboo | bamboo

6 x 7,5 cm



.11



26487
Dust

Supporto per dispositivi multimediali con anello portachiavi. | Mobile device holder made of bamboo with key ring.

Bamboo | bamboo

2,8 x 6 x 1,5 cm



.00



26541
Carota

Supporto per smartphone che funge da amplificatore. | Sound amplifier and smartphone stand.

Bamboo | bamboo

10 x 6 x 3 cm



.11



26320
Fred

Supporto per smartphone in bambù, con una fessura per la ricarica del dispositivo mentre è posizionato sulla base | Support made of bamboo from natural cuts with a slot for charging the device while it is placed onto the base

Bamboo | bamboo

8 x 12 x 8,1 cm



.13



26470
Ginger

Supporto per PC. Piano regolabile sul quale appoggiare il computer, accanto al quale è presente un ulteriore ripiano fisso sul quale appoggiare il mouse. È inoltre dotato di un cassetto porta oggetti. Regolabile in altezza. | PC stand. It has an adjustable surface on which to place the computer, next to which there is an additional fixed shelf on which to place the mouse. It is also equipped with a drawer for objects. Adjustable in height.

Bamboo | bamboo

54 x 34 cm



.13



26501
Gilda

Supporto per tablet e computer, sulla parte destra è dotato di un inserto in PU che funge da tappetino per il mouse. Dotato di scanalatura porta tablet. Barra di protezione per i polsi. | Tablet and computer stand made of bamboo, on the right side it is equipped with a PU insert that acts as a mouse pad. Equipped with tablet holder. Wrist guard bar. The back of the stand features a soft support to protect your knees during use.

Bamboo, canapa | Bamboo, hemp

55 x 36 x 8 cm



.13



26512
Gina

Supporto per tablet e computer con morbido cuscino integrato. Il cuscino è imbottito con particelle di schiuma. Il piano in bambù è dotato di una scanalatura rivestita in plastica, porta tablet. Adatto per pc fino a 15,6 | Tablet and laptop stand made of bamboo with integrated soft cushion. The pillow is filled with foam particles. The bamboo top featured a plastic card slot for tablet. Suitable for laptop max size 15.6

Bamboo | bamboo

37 x 27,5 x 8 cm



MOUSE PAD IN RPET

With wireless
charger.
Mobile and pen
stands included



RECYCLED PLASTIC



WIRELESS CHARGER



26577
Gregorio



Tappetino mouse in RPET con caricatore wireless integrato. Supporto per cellulare e portapenne integrati. | RPET mouse pad with integrated wireless charger. Built-in cell phone holder and pen holder.

RPET | RPET

31 x 27 cm



NATURAL CORK

WIRELESS CHARGER



26437
Bidente



Tappetino mouse con caricatore wireless integrato. Connettore tipo c. Base antiscivolo. Cavo incluso. | Mousepad with built-in wireless charger. Type c connection. Non-slip base. Cable included. Can be folded to use as a phone stand.

Sughero Naturale, Similpelle scamosciata | Natural Cork, Faux Suede

26,5 x 20,5 cm



.11



NATURAL CORK

MAXI MOUSEPAD
53 x 40 cm

NATURAL CORK

.00

.11



57005
Ceanoto

Tappetino da scrivania | Cork desk mat protector.

Sughero | Cork

53 x 40 x 0,3 cm



57008
Altissimo



Tappetino mouse con base antiscivolo | Mouse pad with non-slip base

Sughero | Cork

22 x 18 cm





NON-SLIP SILICONE BASE

EXTRA LARGE



29311
Altivole



Tappetino mouse extra large. Superficie in morbido poliestere particolarmente adatta alla sublimazione, base antiscivolo in silicone. | Extra large mouse pad Soft polyester surface particularly suitable for sublimation, non-slip silicone base.

Poliestere, Silicone | Polyester, Silicone

70 x 35 cm



.02



.02 .08 .01 .23



.02 .01 .08 .04



.23



29262
Bambou



Tappetino mouse dal design rotondo, superficie in poliestere liscio e base antiscivolo in silicone. | Mouse pad with round design, smooth polyester surface and silicone non-slip base

Poliestere, Silicone | Polyester, Silicone

Ø 20 cm



29264
Barlassina

Tappetino mouse con poggia polso. Base in silicone antiscivolo. | Mousepad with wrist-rest in soft. Non-slip base in silicone

Poliestere, Silicone | Polyester, Silicone

20,5 x 24,3 cm



.02



29279
Cotonaria



Tappetino mouse rotondo antibatterico, adatto alla sublimazione. | Round antibacterial mousepad, suitable for sublimation.

Poliestere | Polyester

Ø 20 cm



Antibacterial

.02



29276
Yani



Tappetino mouse antibatterico con certificato di efficacia antibatterica. | Mouse pad made of antibacterial material. Includes antibacterial efficacy certificate

Poliestere | Polyester

22 x 18 cm



.01 .04 .06 .08 .23



.02



29262
Bambou



Tappetino mouse dal design rotondo, superficie in poliestere liscio e base antiscivolo in silicone. | Mouse pad with round design, smooth polyester surface and silicone non-slip base

Poliestere, Silicone | Polyester, Silicone

Ø 20 cm



29092
Franke



Tappetino mouse quadrato con base in silicone antiscivolo. | Square design mousepad with silicone non-slip base.

Poliestere, Silicone | Polyester, Silicone

22 x 18 x 0,15 cm



.02



WIRELESS CHARGER

.01

.01



26279
Haapajärvi

Tappetino mouse con stazione di ricarica wireless con tecnologia Qi integrata. Compatibile con dispositivi dotati di tecnologia di ricarica wireless. | Mouse pad with built-in wireless charging dock with Qi technology. Compatible with devices equipped with wireless charging technology.

Similpelle | Leatherette

28 x 22 cm



29280
Terbio

Tappetino mouse nero | Mouse pad made in black colour pu.

Similpelle | Leatherette

22 x 18 cm



NEW



RECYCLED CARDBOARD



.00

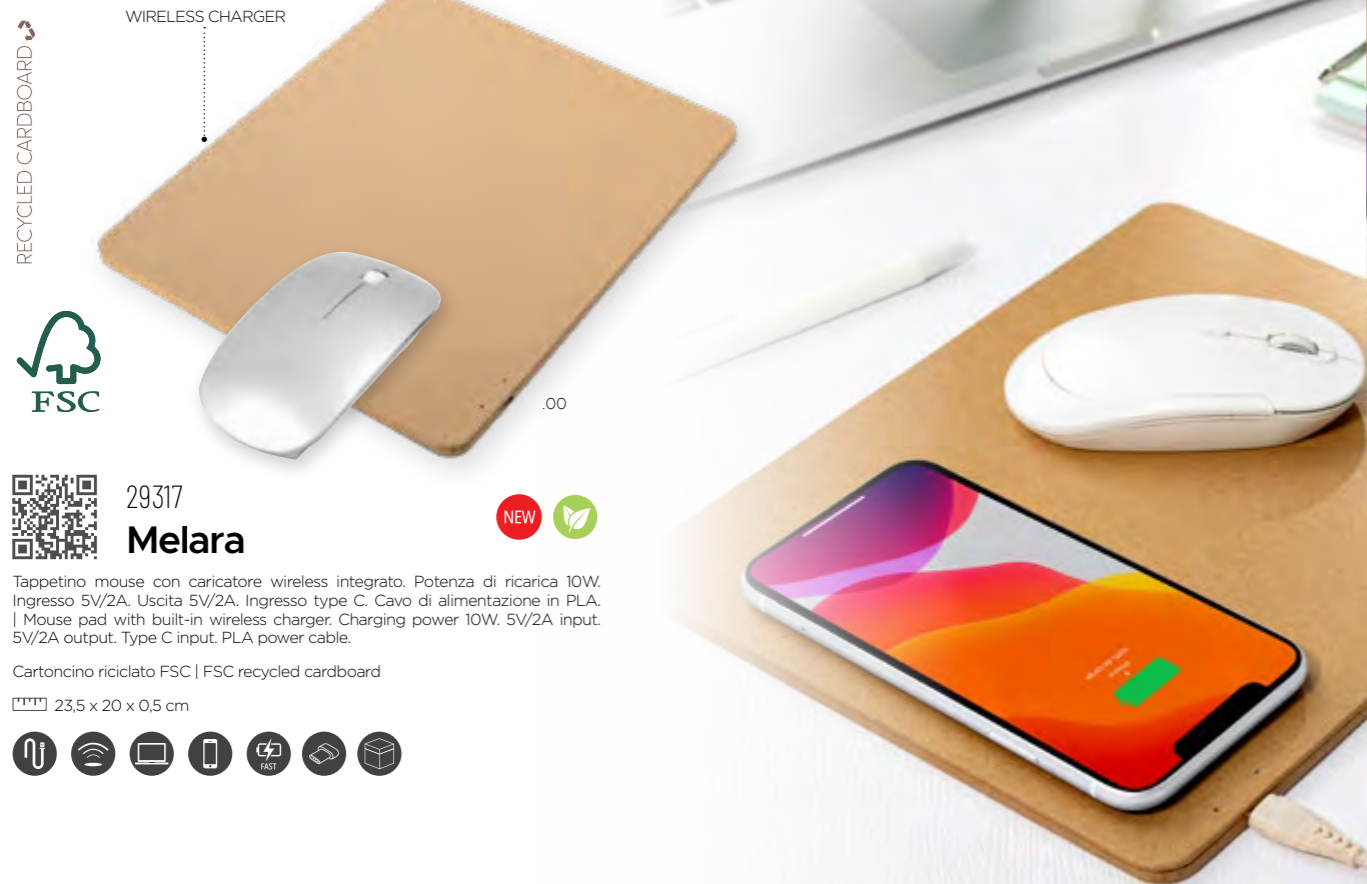

WIRELESS CHARGER

.00

RECYCLED CARDBOARD



29317
Melara

Tappetino mouse con caricatore wireless integrato. Potenza di ricarica 10W. Ingresso 5V/2A. Uscita 5V/2A. Ingresso type C. Cavo di alimentazione in PLA. | Mouse pad with built-in wireless charger. Charging power 10W. 5V/2A input. 5V/2A output. Type C input. PLA power cable.

Cartoncino riciclato FSC | FSC recycled cardboard

23,5 x 20 x 0,5 cm



NEW



WIRELESS CHARGER



26600
Meduna

Organizer da scrivania con caricatore wireless integrato. Potenza 10W. Ingresso 5V/2A. Uscita 5V/2A. Ingresso type C. Cavo di alimentazione in PLA. | Desk organizer with built-in wireless charger. Power 10W. 5V/2A input. 5V/2A output. Type C input. PLA power cable.

Cartoncino riciclato FSC | FSC recycled cardboard

25 x 10 x 1 cm



NEW



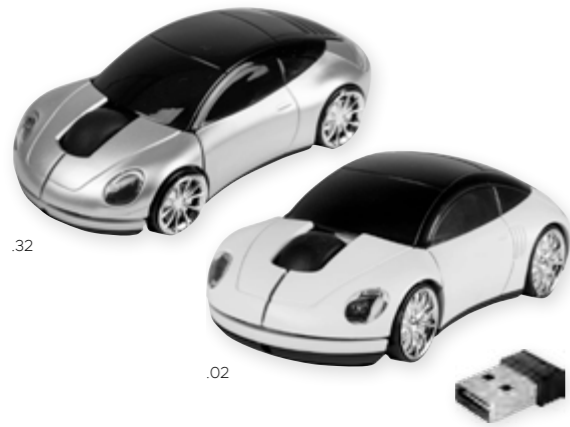

.32

.02



26147
Saiph

Mouse senza fili a forma di automobile. Ricevitore nel bagagliaio della macchina. | Car-shaped wireless mouse. Receiver at the car's boot.

Abs | Abs

11 x 5,5 x 3 cm



.01

.02



26361
Giakarta

Mini mouse wireless con finitura lucida. | Mini size glossy finish wireless mouse.

Abs | Abs

5,5 x 8 x 3,5 cm



.11



26601
Stanghella

Mouse wireless 1600DPI, funziona con 2 batterie AA non incluse. | Wireless mouse 1600DPI, works with 2 AA batteries (not included)

Bamboo, Abs riciclato | Bamboo, recycled Abs

10,2 x 5,8 x 3,4 cm



BAMBOO



.32

.02



.45

.02

.40



26072
Dagny

Mouse senza fili, con due pulsanti e rotellina di scorrimento centrale. Dotato di pulsante DPI per regolare la sensibilità del mouse. | Wireless mouse with two buttons and a central scroll wheel. It has DPI button.

Plastica | Plastic

5,7 x 11,3 x 2 cm



.48



26418
Barlad

Mouse wireless pieghevole con sensore ottico di precisione. Design ergonomico con superficie in gomma. | Wireless optical mouse. Foldable and ergonomic design, in bold colors.

Plastica | Plastic

10,8 x 3,6 x 6 cm



.01

.02



26188
Quebec

Mouse ottico senza fili, design ergonomico, colori solidi. Funziona con 2 batterie AAA non incluse. | Wireless optical mouse with ergonomic design and in bold colours. Battery powered: 2xAAA not included.

Plastica | Plastic

2,4 x 5,7 x 11,2 cm



BAMBOO WOOD



16 gb

.11



26598
Sarcedo

Chiavetta USB con corpo in bambù. | USB stick with bamboo body.
Bamboo | bamboo



WHEAT FIBER



16 gb

.13



26477
Trissino

Chiavetta USB, meccanismo girevole | USB flash drive, with twist mechanism
Metallo, Fibra di grano | Metal, Wheat Fiber



USB MEMORY STICK

Made of wheat fiber.
Presented in eco design box.

BAMBOO WOOD



16 gb

.11



26984
Quick

Chiavetta USB, meccanismo girevole | USB flash drive, with twist mechanism
Metallo, Bamboo | Metal, Bamboo

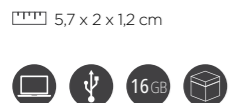

BAMBOO WOOD



16 gb

.11



26234
Kallax

Chiavetta USB girevole, realizzata in bambù. | Swivel USB stick, made of bamboo.
Bamboo | bamboo

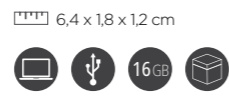

WHEAT FIBER



16 gb

.13



26596
Pontelongo

Chiavetta USB con corpo e parte girevole in fibra di grano. | USB flash drive with body and swivel in wheat fiber.

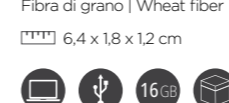

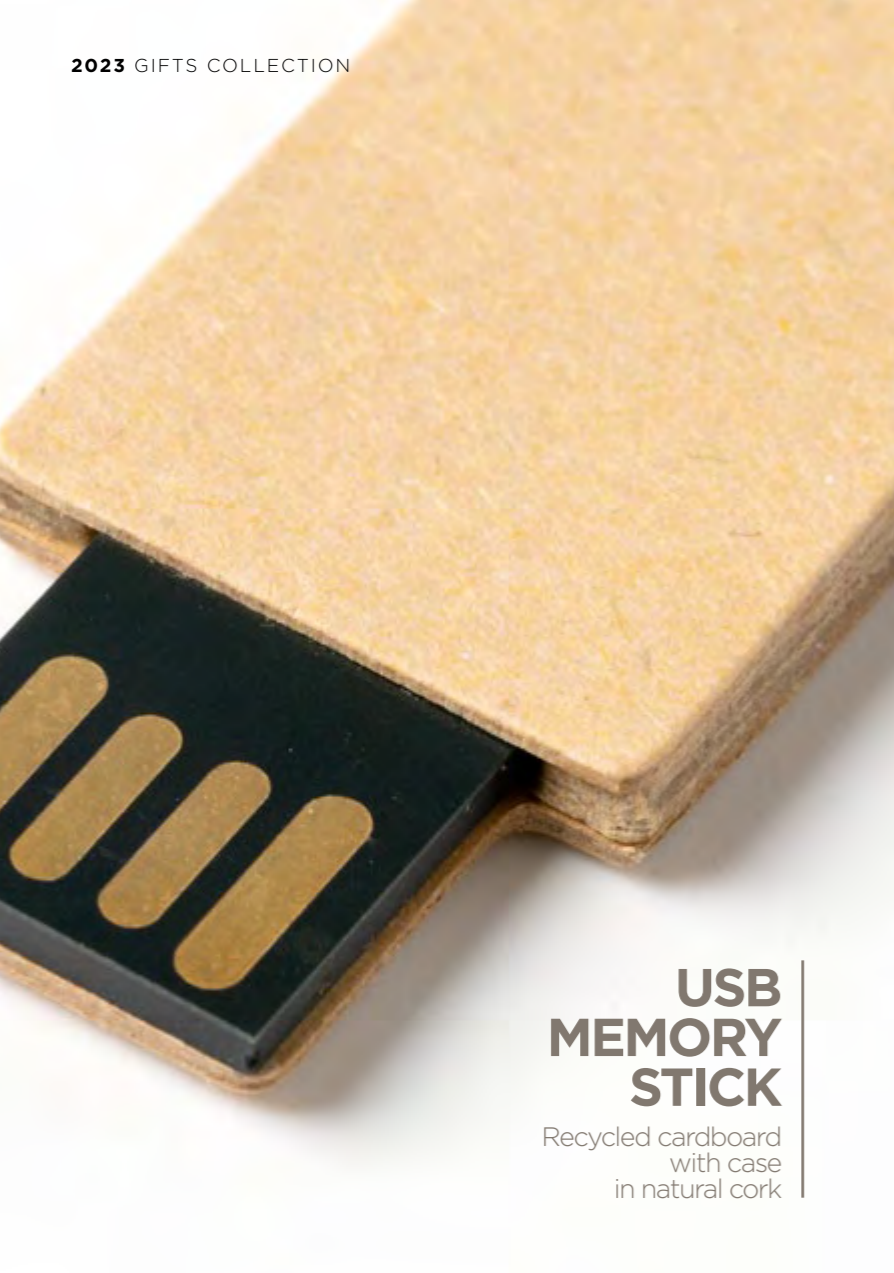

USB MEMORY STICK

Recycled cardboard with case in natural cork



26481
Progeno

Chiavetta USB con custodia in sughero | USB stick with natural cork cover.

Carta, sughero | Paper, cork

5,3 x 1,8 cm



26597
Rocca

Chiavetta USB cilindrica in cartoncino riciclato. | Cylindrical USB flash drive in recycled cardboard.

Cartoncino Riciclato | Recycled Cardboard



26482
Rovolon

Chiavetta USB, meccanismo girevole | USB flash drive, with twist mechanism

Metallo, Carta | Metal, Paper

5,7 x 2 x 1,2 cm



26595
Papozze

Chiavetta USB con corpo in bambù naturale. | USB stick with natural bamboo body.

Bambù | bamboo



BAMBOO WOOD



16 gb



NEW



26054

Mordillo

Chiavetta USB twister | Twister pen drive

Metallo, Plastica | Metal, Plastic

1,8 x 5,7 x 0,9 cm



16/32 gb



26037

Quan

Chiavetta USB twister | Twister pen drive

Metallo, Plastica | Metal, Plastic

1,8 x 5,7 x 0,9 cm



26555

Tantalo

Pendriva 2.0 dal design ultra compatto. Fornita in confezione di cartoncino bianca | 2.0 USB Flashdrive. Presented in an individual white box.

Metallo, Carta | Metal, Paper

3,8 x 1,2 x 0,4 cm



16/32 gb

.32



16 gb

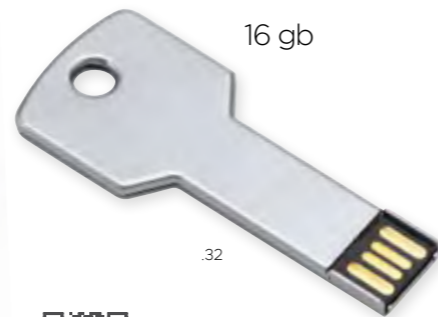

.32



26087

Blake

Chiavetta USB a forma di chiave | USB key

Metallo | Metal

2,4 x 5,7 x 0,2 cm

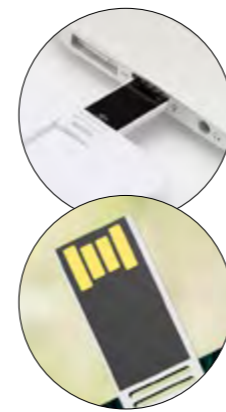

26102

Creditcard

USB a forma di carta di credito | USB credit card

Plastica | Plastic

8,5 x 5,5 x 0,2 cm



16 gb



.02



26024

dati

Penna a sfera con meccanismo a scatto. USB integrata. Con gommino per touch screen. | Ballpen with click action mechanism. Usb integrated. With pointer for touch screen.

Alluminio | Aluminum



26030

Olarevo

Penna a sfera 3 in 1 con gommino per touch screen colorato coordinato, memoria USB integrata. Meccanismo a torsione, inchiostro blu. | 3 in 1 ballpen with pointer for touchscreen in matching colour, and built-in USB memory. Twist action mechanism, blue ink.

Metallo, Plastica | Metal, Plastic



Home and Kitchen

Accessori per la casa di ogni tipo: taglieri in bambù, set di coltelli, rotelle taglia pizza, cavatappi e apribottiglie, set da vino, sacchetti refrigeranti per vino, grembiuli, candele, diffusori, orologi e stazioni meteo.

Home accessories of all kinds: bamboo cutting boards, knife sets, pizza cutter wheels, corkscrews and bottle openers, wine sets, wine cooler bags, aprons, candles, diffusers, clocks and weather stations.

Home and Kitchen





4 COASTERS



74049
Magica



Set da 4 sottobicchieri fornito in custodia di bambù | 4 Coasters set presented in a bamboo individual case

Bamboo | bamboo
11 x 11 x 4 cm



.00



.00



70060
Biedano



Set composto da 4 sottobicchieri. Presentato con un cordino di juta naturale. | Set consists of 4 coasters. Presented with a natural jute cord.

Legno di pino | Pine wood
4 x Ø 10 cm



70059
Navile



Sottobicchiere in bambù | Coaster made of bamboo

Bamboo | bamboo
Ø 9,5 x 0,5 cm



.00

PAPER WITH SEEDS



.00



3004
Monselice



Sottobicchiere ecologico, la carta contiene semi, basterà annaffiarlo per far crescere la piantina. | Ecological coaster, the paper contains seeds, just water it to grow the seedling.

Carta con semi | Paper with seeds
10 x 10 cm



NATURAL CORK



.00



82720
Naomi



Sottobicchiere | Coaster

Sughero | Cork
Ø 10 cm



COOKING TOOLS

Set of 3 tools made of bamboo. It includes fork, spoon, paddle and tools holder.



70020
Lene



Set per insalatiera | Salad set made of natural bamboo wood

Bamboo | bamboo
30 x 6 cm



70100
Baschi



Spatola | Spatula.
Bamboo | bamboo
6 x 30 cm



70402
Kalkgrund



Cucchiaio da cucina. Fornito in bustina singola. | Kitchen spoon in bamboo wood. Presented in an individual bag.

Bamboo | bamboo
30 x 6 cm

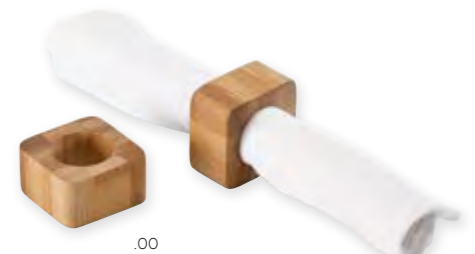

70011
Elin



Insalatiera in bambù | Salad bowl made of natural bamboo wood.

Bamboo | bamboo
21,4 x 21,4 x 6,7 cm



74158
Släkt



Scatola per bustine da tè (non incluse). | Box made of natural bamboo wood for tea bags (not included).

Bamboo | bamboo
16 x 7,8 x 8,7 cm



70019
Mesquite



Set di 2 portatovaglioli | Set of two napkin rings

Bamboo | bamboo
4,5 x 4,5 x 2,5 cm

3 TOOLS



.00



70063
Veigelia



Set di 3 utensili. Include una forchetta, un cucchiaio e una spatola in una pentola. | Set of 3 utensils. Includes fork, spoon, paddle and utensil holder.

Bamboo | bamboo

Holder: Ø 7,5 x 16 cm / Accessories: 30 cm



MAXIMUM CAPACITY 5 KG



.00



72000
Togarashi



Bilancia da cucina digitale con rivestimento frontale in bambù naturale. Capacità massima 5 kg. | Digital kitchen scale with natural bamboo front cover. Maximum capacity 5 kg. Battery included

Bamboo | bamboo
15 x 21,5 x 1,6 cm



SUPPORT FOR A GLASS OF WINE



.11



70031
Bosques



Tagliere per aperitivo con supporto per calice di vino | Chopping board for aperitif with support for a glass of wine

Bamboo | bamboo
20 x 15 x 0,8 cm



70055
Veni



Vassoio da aperitivo a forma di bancale | Happy hour tray, pallet style

Legno | Wood
24 x 16,1 x 3 cm



.13



CUTTING BOARD

Natural bamboo cutting board with liquid collection profile



.00



70065
Oderzo



Tagliere con bordatura scavata per la raccolta dei liquidi. | Natural bamboo cutting board with liquid collection profile.

Bamboo | bamboo
30 x 20 x 1,2 cm





 70006
Capelvenere 

Tagliere con manico fustellato | Board with die-cut handle

Bamboo | bamboo

 30 x 20 x 0,8 cm



 70064
Stagno 

Tagliere con manico che assicura un'ottima presa, dotato anche di cordino per essere appeso. | Wooden cutting board with handle and hanging rope.

Legno | Wood

 15 x 21,5 x 1,6 cm



 70067
Narciso 

Tagliere con manico fustellato | Board with die-cut handle

Bamboo | bamboo

 20 x 15 x 1 cm



BAMBOO ROUND BOARD

Round table board with handle and smooth finish.



 70016
Liam 

Tagliere con manico fustellato | Board with die-cut handle

Bamboo | bamboo

 20 x 15 x 0,8 cm



 70062
Thalia dealbata 

Tagliere rotondo con manico per una migliore presa, finitura liscia. | Round table with handle for easy handling and smooth finish.

Bamboo | bamboo

 42 x 31 x 1,2 cm

Legno di Acacia

Acacia wood

Se vuoi un tagliere che abbia tutti gli aspetti importanti da cercare (**durevolezza, bellezza e resistenza**), non guardare altro che un tagliere in legno di acacia. È anche versatile: parte della bellezza di questo legno è che può essere utilizzato come piatto da portata dopo essere stato utilizzato come tagliere. L'acacia è in realtà una scelta intelligente per un tagliere.

Il legno è estremamente durevole, resistente all'acqua e resiste ai graffi. Anche gli alberi crescono rapidamente, rendendo la loro raccolta sostenibile.





*If you are looking for a cutting board that has all of the important aspects to look for (**durability, beauty and resistance**), look no further than an Acacia wood chopping board. It's versatile too - part of the beauty of this wood is it can be used as a serving platter after being used as a cutting board. Acacia is actually a smart choice for a cutting board.*

The wood is extremely durable, water resistant and resists scratching. The trees grow quickly too, making harvesting them sustainable.





 70074
Ceregnano  
Tagliere da cucina con cordino in juta | kitchen chopping board with jute cord
Legno di acacia nilotica | Nilotic acacia wood
 30,5 x 29,5 x 1 cm



 70073
Cerro  
Tagliere da cucina rettangolare con cordino in juta | Rectangular kitchen chopping board with jute cord
Legno di acacia nilotica | Nilotic acacia wood
 40,5 x 13,5 x 1 cm



 70070
Ceneselli  
Tagliere con manico rotondo. | Chopping board with round handle.
Legno di acacia nilotica | Nilotic acacia wood
 19 x 26 x 1,7 cm



 70068
Cerea  
Vassoio ovale | Oval tray
Legno di acacia nilotica | Nilotic acacia wood
 12 x 15,5 x 1 cm

 70069
Cervarese  
Vassoio lungo | Long tray
Legno di acacia nilotica | Nilotic acacia wood
 25,5 x 7 x 1 cm

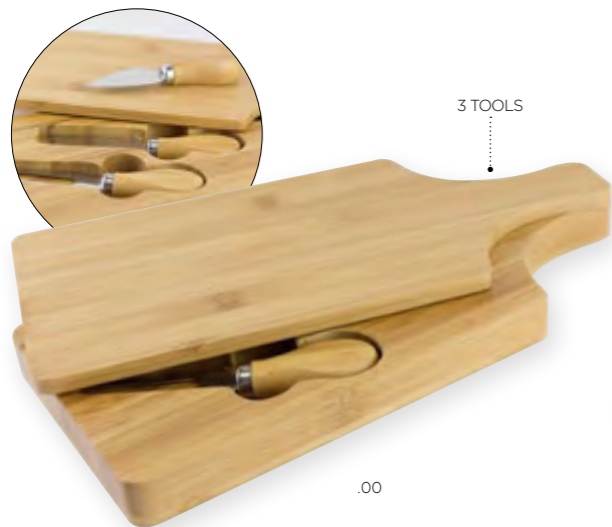

3 TOOLS

.00



70000
girasole

Tagliere con set coltelli per formaggio, comprende 3 tipi di coltello. Coperchio a rotazione | Cheese cutting board with 3 types of knives. Rotating lid.

Bambù, metallo | Bamboo, metal

30 x 14 x 3,1 cm



3 TOOLS

.00



70401
Olaus

Tagliere con due coltelli per formaggio e una forchetta, e una piccola ciotola | Cheese chopping board with 2 cheese knife and one fork, and bowl

Bambù, Acciaio Inossidabile, Ceramica | Bamboo, Stainless Steel, Ceramic

30 x 20 x 1,2 cm



3 TOOLS

.00



70044
Carpino

Tagliere | Tagliere con due coltelli per formaggio e una forchetta. Alloggiamento per i coltelli e la forchetta. | Cheese chopping board with 2 cheese knife and one fork. With die-cut space to hold knife and fork with magnetic detail to hold them.

Bambù | bamboo

33 x 19,5 x 1,5 cm



4 TOOLS

.01



70050
Zeke

Set formaggio con vari utensili. Fornito in confezione singola | Set for cheese with utensils. Presented in an individual case

Legno, Acciaio Inox | Wood, Stainless Steel

19 x 16 x 2,3 cm



4 TOOLS

.00



70041
Betulla

Set da formaggio con 4 utensili in acciaio inox e manico in legno e tagliere nella parte superiore. | Cheese set with 4 utensils in stainless steel and wooden handle with chopping board on the top surface.

Acciaio Inossidabile, legno | Stainless steel, wood

Ø 20 x 3,6 cm



CHEESE CUTTING BOARD

Made of Acacia wood and marble



2 TOOLS

.00



70076
Vighizzolo

Tagliere perfetto per i vostri aperitivi, dotato di due alloggiamenti con coltelli per formaggio inclusi. | Perfect cutting board for your aperitifs, equipped with two slots with cheese knives included.

Legno di acacia, marmo | Acacia wood, marble

29,5 x 20 x 1,3 cm

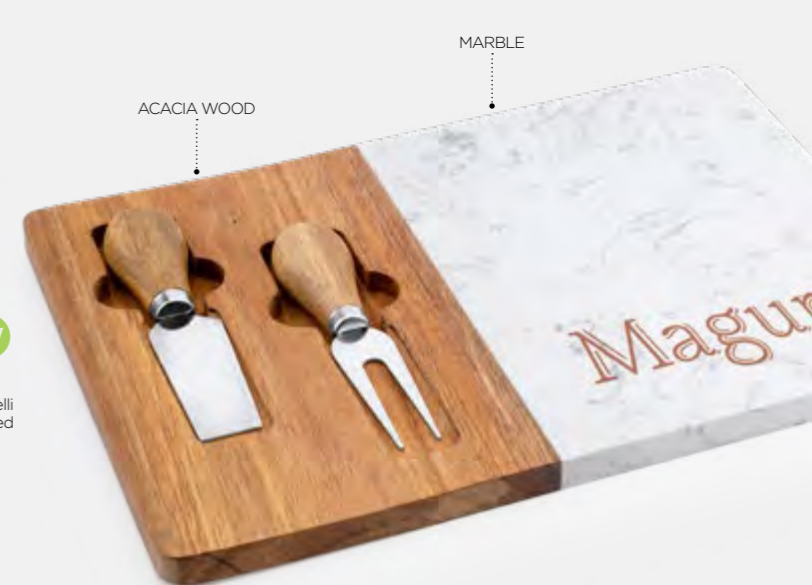

MARBLE

ACACIA WOOD

WINE SET IN STAINLESS STEEL

Pulltap corkscrew with folding blade, drip ring and pouring spout.



76042 Amaranto

Set vino in acciaio inox, cavatappi con tagliacapsule, vaschetta raccogli-gocce e dosatore. | Wine set in stainless steel accessories: pulltap corkscrew with folding blade, drip ring and pouring spout.

Acciaio Inossidabile | Stainless steel

18 x 4 x 11 cm



.00



.32



76049 Indio

Set vino con accessori, comprende cavatappi con taglia capsule, anello salvagoc-cia, tappo e versatore. | Wine set with stainless steel accessories, corkscrew with capsule cutter, bottle opener, stopper and dispenser.

Acciaio Inossidabile | Stainless steel

18 x 4 x 11 cm



76020 Naig

Set vino 4 accessori in elegante scatola regalo. Include cavatappi professionale, tappo per bottiglia, salva goccia e termometro. | Wine set in deluxe wooden gift box 4 pcs. Includes waitress knife, bottle stopper, drip stopper and thermometer.

Legno | Wood

15 x 16 x 5,5 cm



.00



.11



75095 Reid

Set da vino, 4 pezzi, in scatola di legno. Include cavatappi professionale, tappo per bottiglia, salvagocchia e versatore. | Wine set, 4 pcs, in wooden box. Includes waitress knife, bottle stopper, drip stopper and wine pourer

Legno | Wood

Ø 16 x 4 cm



76033 Namur

Set da vino con cavatappi professionale e tappo per bottiglia. Fornito in confezione | Wine set with bottle stopper and waitress knife. Presented in an individual giftbox.

Acciaio | Steel

10,3 x 13,3 x 2,8 cm



.32



76052
Barra



Set vino con accessori, cavatappi con taglia capsula, tappo e salva goccia. Fornito in confezione in bambù con interno sagomato. | Wine set with accessories, corkscrew with capsule cutter, stopper and drip saver. Supplied in bamboo packaging with a contoured interior.

Acciaio Inossidabile, Bambù | Stainless Steel, Bamboo

16 x 10 x 4,5 cm



.00



.00



76006
Tuala



Set vino in legno. Include cavatappi, taglierino, tappo stopper, versatore e anello salvagoccia | Wine set in bamboo wood. Stainless steel accessories. Includes corkscrew, capsule cutter, stopper, dispenser and drip collector.

Bambù | bamboo

36 x 11 x 12 cm



.08



76789
hållö

Set vino a forma di bottiglia. Include cavatappi con taglierino e apribottiglia, versatore, anello salvagoccia. | Wine set, bottle shaped, with a shiny finish, magnetic closure and stainless steel accessories. Includes corkscrew with capsule cutter and opener, dosing cap, drip stop, capsule cutter and stopper.

Plastica, Acciaio | Plastic, Steel

24 x Ø 6,4 cm



.29 .17 .07 .18



.88 .01



.01 .02



82022
Owen

Cavatappi | Corkscrew

Plastica | Plastic

17 x 8 x 3 cm



86072
Argo

Cavatappi classico con taglierino e apribottiglia incorporato. | Classic corkscrew with cutter and built-in bottle opener.

Plastica, Acciaio inossidabile | Plastic, Stainless steel

3,2 x 14 cm



82013
Gambettola

Cavatappi con apribottiglia e coltellino. | Waitress knife with bottle opener, corkscrew and foil cutter.

Plastica, Metallo | Plastic, Metal

13 x 2,5 x 1 cm



CLASSIC CORKSCREW

Stainless steel accessories. Includes capsule cutter and opener



82231 Freddana
Cavatappi, seghetto e apribottiglia. | Corkscrew, saw and bottle opener.
Acciaio Inossidabile | Stainless steel
12 x 2,1 x 1,3 cm



82006 Sam
Cavatappi magnetico a forma di bottiglia di vino. Corpo con finitura semitrasparente. Apribottiglia integrato. | Fun magnetic corkscrew with the shape of a wine bottle. With body in an original translucent finish and opening function.
Plastica | Plastic
11,5 x 2,5 cm



82003 Cem
Cavatappi classico con accessori. Taglierino e apribottiglia incorporato. | Classic corkscrew with stainless steel accessories. Includes capsule cutter and opener.
Alluminio, Acciaio inossidabile, Plastica | Aluminum, Stainless steel, Plastic
11 x 2,5 x 1,3 cm



76000 Kane
Tappo per bottiglia di champagne | Champagne stopper.
Metallo | Metal
Ø 4 x 5,5 cm



82026 Adil
Cavatappi. Con taglierino e apribottiglia. | Corkscrew made of stainless steel, with wooden handle. With foil cutter and bottle opener.
Acciaio Inossidabile, legno | Stainless steel, wood
11 x 2,5 cm



76053 Iridio
Tappo per vino | Wine cork
Metallo | Metal
Ø 1,5 x 6 cm



82008 Tait
Cavatappi con taglierino e apribottiglia. | Comfortable and easy to handle corkscrew with foil cutter and bottle opener.
Metallo | Metal
11 x 2,5 cm



76054 Limana
Tappo per bottiglia realizzato in legno. Prodotto in EU. | Bottle stopper made of wood. Produced in the EU.
Poliiolefine, Legno di faggio | Polyiolefins, Beech wood
2,9 x 3 cm



 82046
Germasino

Apribottiglia. Con foro per lanyard (non incluso). | Aluminium opener with die-cut grip for lanyard -not included-.

Alluminio | Aluminum
[] 3,8 x 0,3 x 8,5 cm



 82122
Nashville

Apribottiglia magnetico con inserto metallico. | Magnetic opener with resistant body with a metal piece for opening.

Plastica | Plastic
[] 5 x 10,5 x 0,5 cm



 82781
Polesella

Apribottiglie | Bottle opener
Legno | Wood
[] 4 x 17,9 x 1 cm



 82074
Scandio

Apribottiglia dal design compatto con interno in acciaio inox e parte superiore sagomata per appenderlo. | Compact design can opener made of natural bamboo
Bambù | bamboo
[] 10,5 x 4 x 1 cm



 82038
Zhelnino

Apribottiglia con inserto in metallo. | Opener with metal opening tool.
Plastica | Plastic
[] 14,8 x 1 x 4,7 cm



 82064
Pimpi

Apribottiglia in Bambù con interno magnetico in acciaio inossidabile, design circolare originale. | Bamboo opener with magnetized side in stainless steel.
Bambù | bamboo
[] Ø 6 x 1,1 cm



 82051
Dodoma

Apribottiglia con manico in legno. | Bottle opener with a wooden handle.
Acciaio Inossidabile, legno | Stainless steel, wood
[] 4 x 2,4 x 13,8 cm



46511
Cissus

Portachiavi apribottiglie | Bottle opener with keyring
Alluminio | Aluminum
7 x 3,5 cm



47155
Sopra

Portachiavi in metallo con apribottiglia. | Keychain made of metal with bottle opener.
Metallo | Metal
2,7 x 5 cm



46067
Robban

Apribottiglia con corpo in alluminio con portachiavi. | Bottle opener with aluminum body with keychain.
Alluminio | Aluminum
1,3 x 6,7 x 1,5 cm



82055
Dynan

Portachiavi apribottiglia | Keychain opener.
Alluminio | Aluminum
7,9 x 1,5 x 0,9 cm



82056
Basel

Portachiavi apribottiglia a forma di bottiglia. | Keychain opener with bottle design
Alluminio | Aluminum
3 x 8,9 x 0,2 cm



46145
But

Apribottiglie con portachiavi | Bottle opener with key chain
Alluminio, Metallo | Aluminum, Metal
6 x 1,1 x 1,5 cm



46081
Josefin

Portachiavi apribottiglia | Bottle opener with keyring.
Alluminio | Aluminum
5,5 x 0,9 x 1,4 cm



74264
Comelico

NEW

Shaker per cocktail con chiusura di sicurezza anti perdita e tappo dosatore. | Cocktail shaker with anti-leak safety lock and dosing cap.

Acciaio Inossidabile | Stainless steel

16,1 x Ø 8,8 cm



74449
Allemansträtten

Shaker per cocktail con finitura semi opaca, capacità 550ml. Chiusura di sicurezza, dosatore nel tappo. | 550ml capacity cocktail shaker in stainless steel with semi-matt finish. Safety lock and dosing cap on top.

Acciaio Inossidabile | Stainless steel

Ø 8,7 x 21,5 cm



74263
Falcade

NEW

Set per cocktail. Include bicchierino dosatore, shaker da 580ml, colino e cucchiaino. Fornito con pouch. | Cocktail set. Includes measuring cup, 580ml shaker, strainer and spoon. Supplied with pouch

Acciaio Inossidabile | Stainless steel

29,5 x Ø 8,7 cm



74262
Cona

NEW

Cubetti di ghiaccio riutilizzabili, forniti in pouch di cotone | Reusable ice cubes, supplied in a cotton pouch

Cubi: marmo, Pouch: cotone | Cubes: marble, Pouch: cotton

8,5 x 11 cm



74271
Liona

NEW

Misurini in acciaio inox da 15ml e 30ml. | 15ml and 30ml stainless steel measuring cups.

Acciaio Inossidabile | Stainless steel

6,9 x Ø 3,9 cm



.13

A



17052
Berk



Borsa porta bottiglie con due scompartimenti individuali, con finestra. Manici rinforzati. | Bottle bag with two individual compartments, with window. Reinforced handles.

Juta laminata | Laminated jute

20 x 34,5 x 10 cm



.13

B



17369
Feltre



Borsa porta bottiglie. Manici rinforzati. Ideale per contenere due bottiglie. | Bottle bag. Reinforced handles. Ideal for holding two bottles.

Cotone, juta | Cotton, jute

20 x 35 x 10 cm



.13

C



17049
Sezar



Borsa con finestra. Manici rinforzati. Perfetta per contenere una bottiglia. | Bag with window. Reinforced handles. Perfect for holding a bottle.

Juta laminata | Laminated jute

10,5 x 35 x 10 cm



.13

D



17358
Bosaro



Elegante borsa porta bottiglia, adatta a diversi formati | Elegant bottle bag, suitable for different size bottles

Canvas naturale laminato, juta laminata | Laminated natural canvas, laminated jute

11 x 35 x 10 cm

ELEGANT BOTTLE BAGS

Bottle bags with reinforced handles. Made of laminated natural canvas and laminated jute.





.01 .10



17156
Vibeke

Borsa porta bottiglia di vino con manici corti. Finiture cucite. | Wine bottle bag with short handle. Stitched finishing.

TNT No-woven | TNT No-woven

10 x 33 x 10 cm



.01



17170
Castagna

Borsa porta bottiglia di vino con manico fustellato. Finiture cucite. | Wine bottle bag with short handle. Stitched finishing.

TNT No-woven | TNT No-woven

13 x 40 x 10 cm



.21



17199
Basaluzzo

Borsa porta bottiglia, con manici corti. Finiture termosaldate. | Wine bottle bag in PVC, transparent design, with short handle. Heat-sealed finishing.

Pvc | pvc

11,5 x 11 x 25 cm



.21



17112
Acerola

Borsa refrigerante con manici rinforzati resistenti e liquido refrigerante all'interno. | Original cooler bag with resistant reinforced handles and coolant liquid inside.

Pvc | pvc

10 x 25 x 10 cm



.13



17319
Lutezio

Borsa per una bottiglia di vino, con finestra trasparente su un lato. | Bag for a wine bottle made of high density jute

Juta | Jute

11 x 10,5 x 35 cm



.04



17324
Málà

Borsa porta bottiglia, con finiture termosaldate. Soffietto alla base. Manici fustellati. | Special heat-sealed bag for bottles, with folding at the base. Manicci fustellati.

TNT No-woven - 80gr/m2 | TNT No-woven - 80gr/m2

17 x 40 cm



.05 .10 .01



.01

.10

.05



76055
Rovigo

Custodia termica per bottiglie, con cinturini elastici per una perfetta regolazione. | Thermal case for bottles, with elastic straps for a perfect fit.

Poliestere | Polyester

15,5 x 22,5 cm



RECYCLED PLASTIC



.01



76056
Sernaglia

Custodia termica per bottiglie, con chiusura in velcro regolabile. | Thermal case for bottles, with adjustable velcro closure.

RPET | RPET

40 x 18 cm





6 L

.32



17328
Mendelevio

Secchiello con manico, comprende apribottiglia. Capacità 6 litri. | Metal Bucket with handle, includes opening

Metallo, Alluminio | Metal, Aluminum

23 x 18,5 cm



6 L

.02

.01

.23

.04

.08



17388
Monastier

NEW

Secchiello con apribottiglie in alluminio incorporato. Capacità 6 litri. | Bucket with built-in aluminum bottle opener. Capacity 6 litres.

Metallo | Metal

23 x 18,5 cm



RECYCLED COTTON



.13

.01



17396
Thiene

Presina con certificato DPI | Pot holder with PPE certificate

Cotone riciclato / Poliestere | Recycled cotton / Polyester

17,5 x 17,5 cm



.06

.04

.07

.08

.05



17333
Nigella

Set da cucina composto da un guanto da cucina e una presina. Un lato liscio ideale la stampa, dotati di anellino per appenderli. | Kitchen set consisting of a soft cotton/polyester mitt and a potholder.

Cotone, poliestere | Cotton, polyester

Glove: 19 x 30,5 cm ; Pot Holder: 17 x 17 cm



.13

ORGANIC COTTON



.05 .01 .13

RECYCLED COTTON



17209
Canale

Guanto da cucina con un lato piatto per la stampa. Anellino per appenderlo. | Kitchen mitten with a flat side for printing. With hanging loop.

100% Cotone Organico | 100% Organic Cotton

19 x 30,5 cm



17295
Paradiso

Guanto da cucina. Con certificato EPI. | Mitten with IPE certificate.

Esterno: 100% cotone riciclato - 300 gr/m2, Interno: 50 gr TNT No-woven | External: 100% recycled cotton - 300 gr/m2, Internal: 50 g TNT No-woven

17 x 26 cm



HANGING STRAP



.08 .05 .04 .01



17194
Grotte

Guanto da cucina, con una delicata finitura bianca e bordi colorati. Un lato liscio appositamente pensato per la sublimazione. Gancino per appenderlo. | Kitchen mitten with a soft white finish and brightly coloured edges. With a smooth side especially designed for sublimation and hanging strap.

Poliestere | Polyester

19 x 30,5 cm



.13

RECYCLED COTTON



17387
Megliadino

Guanto da cucina, con un lato liscio ideale per la personalizzazione e un occhio per appenderlo. | Oven glove, with a smooth side ideal for personalization and an eyelet for hanging.

Cotone riciclato | Recycled cotton

18,5 x 26 cm



.11 .23 .08 .02 .03 .01



17161
Fahad

Guanto da cucina. Con un lato liscio dedicato alla stampa. Con anellino per appenderlo. | Kitchen mitten in of cotton and polyester. With a plain side especially designed for printing and hanging strap.

Cotone, Poliestere | Cotton, Polyester

16 x 26 cm



17274
Lupita

Guanto da cucina. Un lato liscio appositamente pensato per la stampa. Gancino per appenderlo | Kitchen mitten. With a smooth side especially designed for printing and hanging ribbon.

Cotone, Poliestere | Cotton, Polyester

19 x 30,5 cm

HANGING STRAP



LONG APRON

Strap with plastic closure. Front pocket

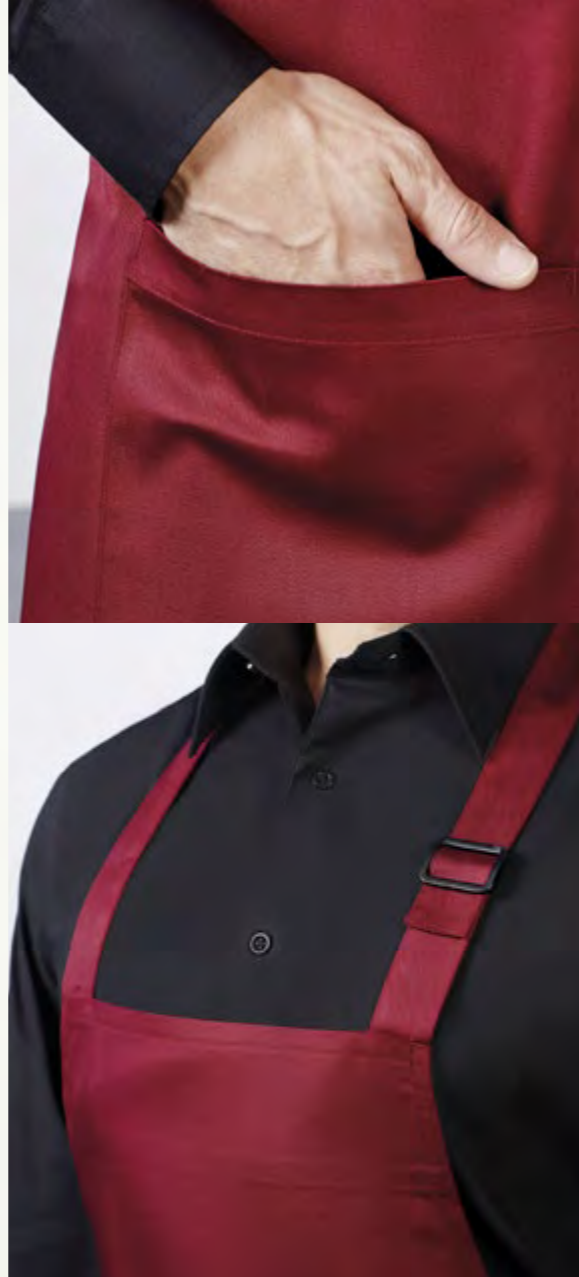

17338
Mura

Grembiule lungo. Tracolla con fibbia in plastica. Tasca frontale. | Long apron. Strap with plastic closure. Front pocket.

80% Poliestere, 20% Cotone - 220 gr/m² | 80% Polyester, 20% Cotton - 220 gr/m²

75 x 90 cm

220 gr/m²



17475
Auce

Comodo grembiule da cucina. Ampia tasca frontale, allacciatura in vita coordinata. | Comfortable long apron. Big size pocket on front, tie back closure in matching colour.

Cotone - 180 gr/m² | Cotton - 180 gr/m²

65 x 90 cm

180 gr/m²



17314
Uzlovaja

Grembiule con cinghie regolabili. Ampia area di stampa particolarmente adatta alla sublimazione. | Apron with adjustable straps. Large printing area especially designed for sublimation

Poliestere | Polyester

65 x 90 cm

180 gr/m²



17008
Axel

Grembiule con tasca frontale e cinghia regolabile. | Apron with front pocket and adjustment straps.

65% Poliestere, 35% Cotone | 65% Polyester, 35% Cotton

75 x 80 cm

200 gr/m²



17004
Xen

Grembiule da cucina bicolore. Tasca frontale | Apron bicolore. Frontal pocket

Cotone | Cotton

79 x 59 cm

145 gr/m²



.05 .01



.13 .01



RECYCLED COTTON



17294 **Trifoglione**

Grembiule lungo con chiusura regolabile. Ampia tasca frontale. | Apron with adjustable closure. Pocket on front.

Cotone riciclato | Recycled cotton

65 x 90 cm

140 gr/m²



17293 **Ravanello**

Grembiule con chiusura regolabile. | Apron in Fairtrade cotton with adjustable closure.

Cotone Fairtrade | Fairtrade cotton

65 x 93 cm

180 gr/m²



.13



17383 **Tomaso**

Grembiule con tasca frontale. Misura unica regolabile. | Front pocket apron. One size adjustable.

Cotone Fairtrade | Fairtrade cotton

65 x 90 cm



.01 .04 .05

100% HEMP FABRIC



17380 **Quertesolo**

Grembiule con tasca frontale. Misura unica regolabile. | Front pocket apron. One size adjustable.

Canapa - 200 gr/m² | Hemp - 200 gr/m²

65 x 90 cm

200 gr/m²



APRON IN RECYCLED COTTON

Apron with front pocket and tie back closure



17241
Sabbia



Grembiule con ampia tasca frontale, allacciatura in vita. | Apron with front pocket and tie back closure.

Cotone riciclato - 140gr/m2 | Recycled cotton - 140 gr/m2

65 x 90 cm

140 gr/m²



ORGANIC COTTON



17208
Cadino



Grembiule. Ampia tasca frontale, allacciatura in vita coordinata. | High quality apron. Big size pocket on front, tie back closure.

100% Cotone Organico - 180 gr/m2 | 100% Organic Cotton - 180 gr/m2

65 x 93 cm

180 gr/m²



RECYCLED COTTON



17498
Marano



Grembiule con tasca frontale. | Apron with front pocket
Cotone riciclato - 140gr/m2 | Recycled cotton - 140gr/m2

65 x 90 cm

140 gr/m²



17330
Giustina



Grembiule con tasca frontale. | Apron with front pocket
Cotone riciclato - 140gr/m2 | Recycled cotton - 140gr/m2

65 x 90 cm

140 gr/m²



RECYCLED COTTON



17339
Musetta

Grebiule da cucina con effetto denim. Ampie tasche frontali. Tracolla regolabile. | Kitchen apron with denim effect. Large front pockets. Adjustable shoulder strap.

100% Cotone - 250gr/m2 | 100% Cotton - 250gr/m2

65 x 93 cm

250 gr/m²



17340
Musetto

Grebiule corto con due tasche. Cintura regolabile in vita. | Short apron with two pockets. Adjustable waist belt.

Cotone, Viscosa, Poliestere - 250 gr/m2 | Cotton, Viscose, Polyester - 250 gr/m2

50 x 35 cm

250 gr/m²

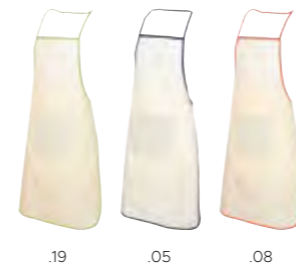

.19 .05 .08



.02



.02 .19 .08 .13 .07



17005
Erim

Grebiule da cucina con bordi colorati e cinghia per il collo colorata. Regolabile con cinghie colorate. | Apron in 100% cotton in natural colour with coloured edges and neck strap. Adjustment coloured straps.

Cotone | Cotton

79 x 59 cm

105 gr/m²



17071
Grill

Grebiule. Ampia tasca frontale e cinghie regolabili coordinate. | Apron in 100% cotton material. With big size front pocket and adjustment straps.

Cotone - 195 gr/m2 | Cotton - 195 gr/m2

60 x 90 cm

195 gr/m²



17000
Rita

Grebiule. Ampia tasca frontale e cinghie regolabili coordinate. Nastro dietro al collo bicolore. | Apron in 100% polyester material cotton touch. With big size front pocket and adjustment straps in matching colour. With neck straps in bicolour design.

Tc - 150 gr/m2 | Tc - 150 gr/m2

65 x 90 cm

150 gr/m²

APRON IN DENIM COTTON

with adjustable fastening, front pocket



17394
Stino

NEW

Grembiule con chiusura regolabile, dettagli in PU e tasca frontale. | Apron with adjustable closure, PU details and front pocket.

Cotone Denim - 190 gr/m2 | Cotton Denim - 190 gr/m2

65 x 90 cm

190 gr/m²



17309
Fratta

NEW

Grembiule lungo, con anello porta apri bottiglie integrato nell'ampia tasca frontale. Tracolla regolabile. | Long apron with contrasting cotton canvas inserts and bottle opener ring integrated in the large front pocket. Closing laces in cotton canvas. Adjustable shoulder strap.

Cotone Canvas - 300gr/m2 | Cotton Canvas - 300gr/m2

66 x 78 cm

300 gr/m²



17305
Vigasio

NEW

Grembiule corto, con anello porta apri bottiglie integrato nell'ampia tasca frontale. Tracolla regolabile. | Short apron with contrasting cotton canvas inserts and integrated bottle opener ring in the large front pocket. Closing laces in cotton canvas. Adjustable shoulder strap.

Cotone Canvas - 300gr/m2 | Cotton Canvas - 300gr/m2

71 x 42,5 cm

300 gr/m²





WOMEN'S SHIRT
R5068

MAN'S SHIRT
R5507



17341
Nanà

Grembiule corto con due tasche. Cintura regolabile in vita. | Short apron with two pockets. Adjustable waist belt.

Poliestere, Cotone - 220 gr/m2 | Polyester, Cotton - 220 gr/m2

45 x 30 cm

220
gr/m²



COTTON 220 GR/M²

.01



17342
Nancy

Grembiule corto con due tasche. Cintura regolabile in vita. | Short apron with two pockets. Adjustable waist belt.

Poliestere, Cotone - 220 gr/m2 | Polyester, Cotton - 220 gr/m2

71 x 43 cm

220
gr/m²



COTTON 220 GR/M²

.01



17201
Alesund

Grembiule corto da cucina con tre tasche frontali. Regolabile con cinghie. | Short cotton apron with 3 pockets on front. Adjustable with straps. Large printing area.

Cotone - 250 gr/m2 | Cotton - 250 gr/m2

48 x 30 cm

250
gr/m²



COTTON 250 GR/M²

.01

.10



.01

.02



17037
Oder

Cappello da cucina in morbido e resistente materiale, con nastro interno regolabile | Kitchen cap in soft and comfortable TC material with adjustable ribbon.

35% Cotone, 65% Poliestere | 35% Cotton, 65% Polyester

27,5 x 20 cm

200 gr/m²



.02



17345
Naia

Berretto in stile militare con retina traspirante sulla parte superiore | Military style hat with breathable mesh on the top.

Poliestere, Cotone - 195 gr/m² | Polyester, Cotton - 195 gr/m²

Taglia S-L / Size S-L

195 gr/m²



.02



17346
Nala

Cuffia con rete cattura-capelli e visiera rigida | Mob-cap with mesh to collect hair and rigid visor

Poliestere, Cotone - 195 gr/m² | Polyester, Cotton - 195 gr/m²

Taglia Unica / One size

195 gr/m²

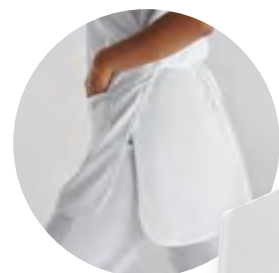

17347
Nadine

Grembiule reversibile unisex | Unisex reversible chasuble.

Poliestere, Cotone - 195 gr/m² | Polyester, Cotton - 195 gr/m²

Taglia Unica / One size

195 gr/m²



.02



.01 .02 .04 .19

.08 .05 .06 .17



.23 .06 .07 .08

.01 .02 .04 .17



.02 .01 .23 .08



17081
Uno

Grembiule con tasca frontale e cinghie di chiusura regolabili. | Apron with front pocket and adjustment straps.

TNT No-woven | TNT No-woven

50 x 73 cm

80 gr/m²



17344
Mysterio

Grembiule lungo con nastro in tinta sul collo e nastri laterali per l'allacciamento. Ampia tasca frontale | Long apron with matching ribbon on the neck and side ribbons for lacing. Large front pocket

Poliestere, Cotone - 150 gr/m² | Polyester, Cotton - 150 gr/m²

65 x 90 cm

150 gr/m²



17343
Muso

Grembiule lungo con nastro in tinta sul collo e nastri laterali per l'allacciamento. | Long apron with matching ribbon on the neck and side ribbons for lacing.

Poliestere, Cotone - 150 gr/m² | Polyester, Cotton - 150 gr/m²

65 x 90 cm

190 gr/m²



.00



70072
Chioggia



Set sushi fornito in pouch. Comprende due tappetini per il sushi, 2 paia di bacchette, 1 palettina per il riso, 1 spargitore | Sushi set supplied in a pouch. Includes two sushi mats, 2 pairs of chopsticks, 1 rice scoop, 1 spreader

Bamboo | bamboo

Mat: 24 x 24 cm / Spoon: 6,3 x 20,5 cm / Scoop: 4

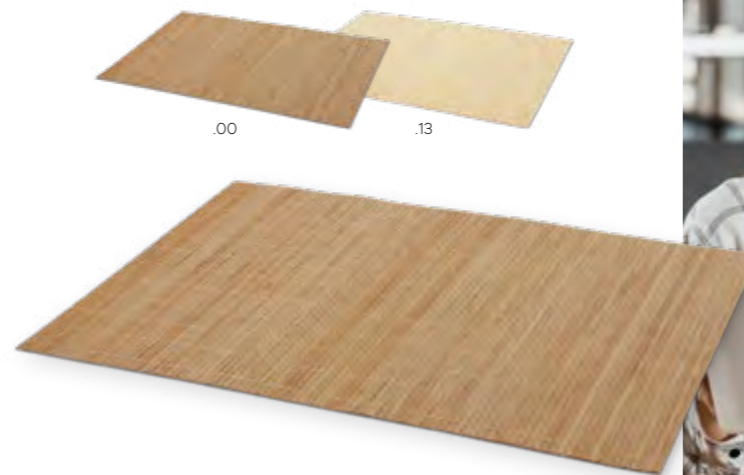

.00

.13



79118
Cimadolmo



Tovaglietta da tavola. Fornita in polybag singola. | Tablecloth Supplied in a single polybag.

Bamboo | bamboo

49,5 x 35 cm



**COASTERS
AND PLACEMATS**
Made of bamboo



.11

SUSHI BOARD



70071
Chiuppano



Vassoio giapponese per sushi | Japanese sushi tray

Bamboo | bamboo

28,5 x 19 x 3 cm



.00

.13



70075
Cibiana



Set composto da 5 sottobicchieri in bambù. Fornito in polybag singola. | Set consisting of 5 bamboo coasters. Supplied in a single polybag.

Bamboo | bamboo

10 x 10 cm



100% COTTON

FAIRTRADE

Somilux

NEW

17386
Fregona

Strofinaccio da cucina. | Kitchen towel.
Cotone - 180 g/m² | Cotton - 180 gr/m²
40 x 65 cm

180 gr/m²

.13

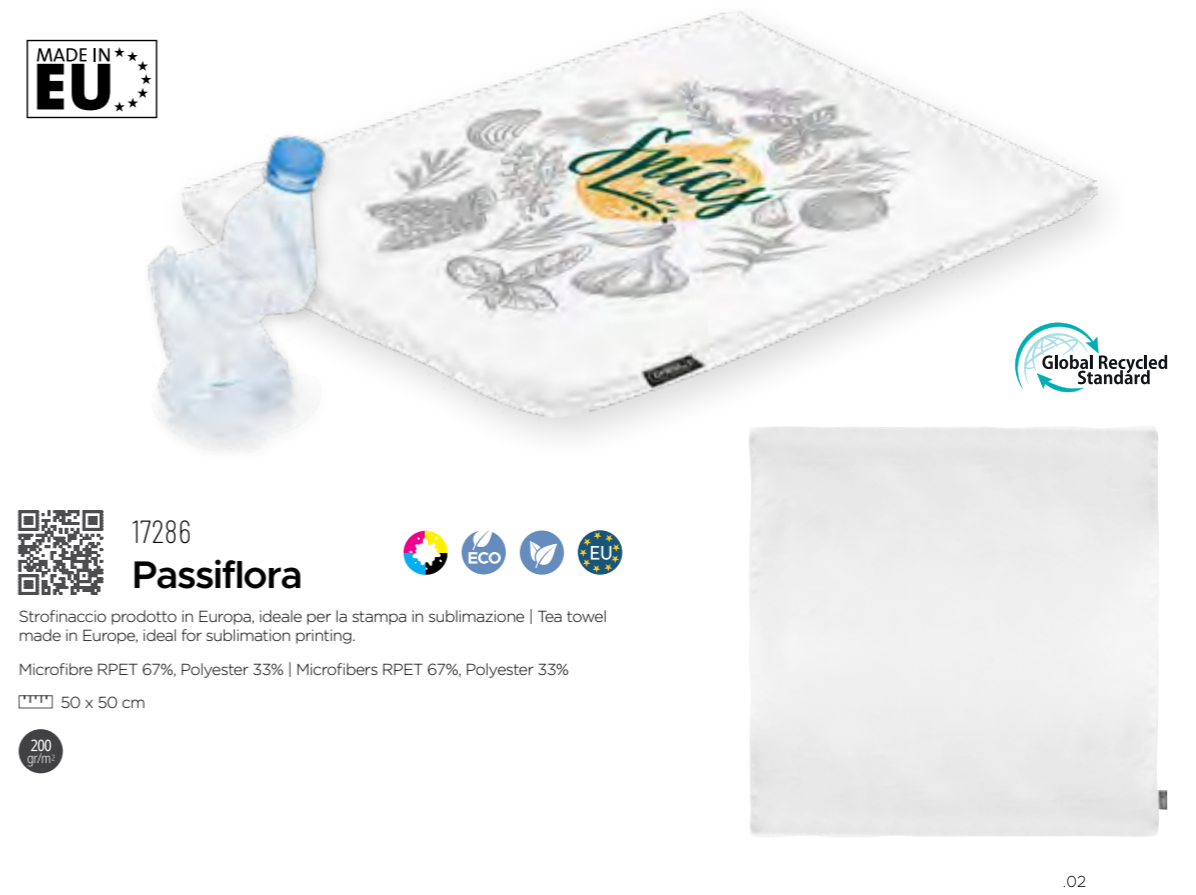

MADE IN EU

Global Recycled Standard

17286
Passiflora

Strofinaccio prodotto in Europa, ideale per la stampa in sublimazione | Tea towel made in Europe, ideal for sublimation printing.
Microfibre RPET 67%, Polyester 33% | Microfibers RPET 67%, Polyester 33%
50 x 50 cm

200 gr/m²

.02



100% COTTON

17210
Carpina

Strofinaccio da cucina. Con anellino per appenderlo. | Cooking cloth. Includes a hanging loop.
100% Cotone - 180gr/m² | 100% Cotton - 180gr/m²
40 x 65 cm

180 gr/m²



100% COTTON

17284
Nespolo

Canovaccio. Include una linguetta per appenderlo. Può essere realizzato in colore pantone a partire da 350pz. | Kitchen towel. Includes a tab to attach it. From 350pccan be produce in pantone color.
Cotone - 180gr/m² | Cotton - 180gr/m²
40 x 65 cm

180 gr/m²

CHOOSE YOUR PANTONE COLOR



SEAQUAL

MADE IN EU

17279
Guzmania

Strofinaccio bianco in cotone riciclato e SEAQUAL (tessuto realizzato con filati riciclati e plastica pescata in mare) | White towel made of recycled cotton and SEAQUAL (fabric made with yarn from recycled materials and plastic caught from the sea).
70% Cotone riciclato, 30 % Seaqual | 70% Recycled Cotton, 30% Seaqual
50 x 50 cm

450 gr/m²

SEAQUAL

What is the SEAQUAL initiative? It is an initiative that seeks to challenge the plastic pollution of our oceans by cleaning up marine litter and promoting an increasingly sustainable society.

SEAQUAL fabrics are made with polyester yarns from recycled materials from the sea, thus helping to preserve natural resources and keep the oceans clean.

With a production process with controlled traceability, most of the plastics collected are recycled and transformed into yarns based on responsible processing. The result is a fabric that meets all quality standards.





79105
Issopo

Tovaglia | Tablecloth
Cotone Fairtrade - 140 gr/m2 | Fairtrade cotton - 140 gr/m2
30 x 45 cm

140 gr/m²



.13



17223
Formone

Sottile borsa per il pane in cotone. Manici corti. | Slim bag for bread. Short handles.
Cotone | Cotton
20 x 50 cm

140 gr/m²



.13



17016
Elvan

Borsa portapane con chiusura con coulisse coordinata. Finiture cucite | Bread bag with matching colour drawstring closure. Stitched finishing.
100% Cotone - 105gr/m2 | 100% Cotton - 105gr/m2
20 x 58,5 cm

105 gr/m²



.13

100% COTTON 725 GR/M²

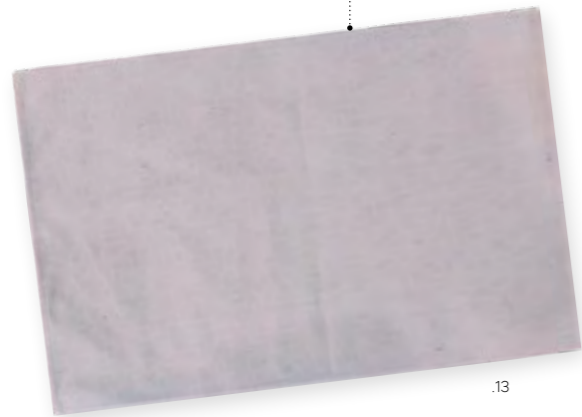

.13



.08



.01

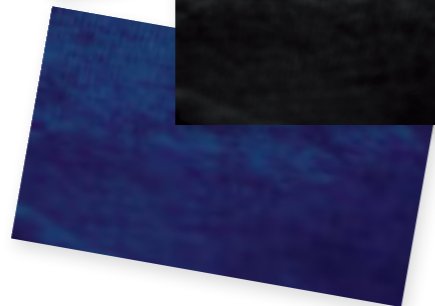

.05



79125
Villorba

Tappeto ideale per arredare diversi ambienti della casa. | Ideal carpet for decorating different rooms in the house.

Cotone - 725 gr/m2 | Cotton - 725 gr/m2

60 x 0,5 x 40 cm

725 gr/m²



79013
Oliver

Tovaglietta da tavola | Table napkins

TNT No-woven | TNT No-woven

40 x 30 cm



17371
Chiampo

Cestino per il pane | Bread basket

Cotone, juta naturale | Cotton, natural jute

20 x 15 cm



.13



17233
Garigione

Cestino per il pane. Finiture cucite. Con bordo ripiegato | Breadbasket. Stitched finishing. With folding edge.

100% Cotone - 220gr/m2 | 100% Cotton - 220gr/m2

∅ 14 x 16 cm



.13

100% COMPOSTABLE



79035
Heta



Vaso con semi di petunia, in materiale biodegradabile. Con 5-8 semi di petunia e bustina con substrato di coltivazione. | Pots with Petunia seeds in biodegradable material. With 5-8 seeds and sachet with growing substrate.

Vaso | Jar

∅ 6,5 x 6,2 cm

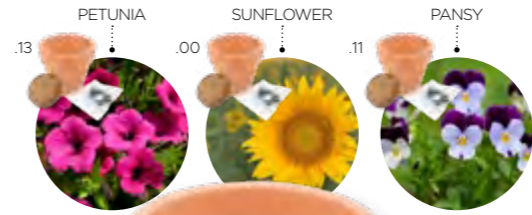

79126
Crespadoro



Vasetto in terracotta con semi e terra | Clay pot with seeds. Growing medium included

Terracotta | Terracotta

5,5 x 6 cm



100% COMPOSTABLE



79127
Limena



Vasetto in materiale biodegradabile, semi disponibili: petunia, girasole, pensamento. Fornito in confezione singola in cartoncino. | Pot in biodegradable material, seeds available: petunia, sunflower, penny. Supplied in single cardboard box.

Bio | Bio

5,5 x 6 cm



SUNFLOWER



PARSLEY BASIL



BASIL



79119
Terme



Vasetto con semi di girasole. Substrato di coltivazione incluso. | Clay pot with sunflower seeds. Growing medium included.

Terracotta | Terracotta

6 x 5 cm



79121
Vallada



Set composto da due vasetti con semi di prezzemolo e basilico. Substrato di coltivazione incluso. | Set consisting of two jars with parsley and basil seeds. Growing medium included.

Terracotta | Terracotta

12 x 5 cm



79092
Puffi



Vasetto in terracotta con terriccio per la coltivazione e semi di basilico. | Terracotta pot that includes ground and Basil seeds.

Terracotta | Terracotta

∅ 5,5 x 5 cm



100% COMPOSTABLE



BASIL

CHIVE

CILANTRO

OREGANO



COTTON BAG



79111
Paprica



Vaso biodegradabile con torba e capsula di semi. Erba cipollina, basilico e origano. | Biodegradable pot with peat pill and seed capsule. Chives

Vario | Varied

∅ 6 x 6 cm



 79117
Concordia  

Candela profumata in bicchiere di vetro satinato con coperchio in bambù. Fragranza alla vaniglia. | Scented candle in frosted glass with bamboo lid. Vanilla fragrance

Vetro, Cera | Glass, Wax

 8,8 x Ø 7 cm



 79116
Conegliano  

Candela profumata in bicchiere di vetro con coperchio in sughero. Fragranza alla vaniglia. Fornita con cartoncino kraft per la personalizzazione. | Scented candle in glass with cork lid. Vanilla fragrance Supplied with kraft card for personalization.

Vetro, Cera | Glass, Wax

 7,6 x Ø 5,6 cm







CANDLE HOLDER

Made of acacia wood. Durability, beauty and resistance.



 79112
Conselve  

Porta candela realizzato in legno di acacia. Fornito con candela da 10gr | Candle holder made of acacia wood. Supplied with 10g candle

Legno di acacia nilotica | Nilotic acacia wood

 6 x 4,5 x 6 cm



 79091
Escaplano

Candela in vetro con tappo in sughero | Candle with cork lid

Vetro, Sughero | Glass, Cork

 Ø 5 x 7 cm





 79097
Monstera 

Candela in vetro prodotta in Europa. Cera vegetale e paraffina raffinata | Candle made in Europe with glass container. Vegetable wax, refined paraffine

80% Cera vegetale, 20% paraffina raffinata | 80% vegetable wax, 20% refined paraffin

 Ø 6,5 x 8 cm





 79096
Mandorlo 

Candela in vetro dipinto, cera vegetale e paraffina profumata, con coperchio in bambù. Prodotta in Europa. | Painted glass candle with vegetable wax and scented paraffin, with bamboo lid. Made in Europe.

Vetro, Bamboo, Cera vegetale, Paraffina 95%, Profumo 5% | Glass, Bamboo, Vegetable wax, Paraffin 95%, Perfume 5%

 Ø 7 x 8,5 cm







 79103
Fersinone

Candela profumata aroma vaniglia. Con vasetto in ardesia con gessetto incluso. | Scented candle vanilla aroma. With slate jar with one chalk included.

Vetro | Glass

 7,8 x Ø 7 cm





79113
Conte



Candela di cera da 85gr, fornita in bicchiere di vetro color oro. Aroma di bergamotto al 6%. | 85g wax candle, supplied in gold colored glass. 6% bergamot flavor.

Vetro, Cera | Glass, Wax

☐ ☐ ☐ ☐ Ø 6,2 x 7,4 cm



79106
Itterbio

Candela profumata in vaso di vetro colorato con varie fragranze (caffè, pino, lavanda, vaniglia e fragola). | Scented candle in colored glass jar with various fragrances (coffee, pine, lavender, vanilla and strawberry)

Vetro | Glass

☐ ☐ ☐ ☐ Ø 5,6 x 6,7 cm



79107
Panch



Set profumatore ambiente, con boccettina da 100 ml di note balsamiche, erbacee e di anice, e bastoncini in legno. | Ambient fragrance set, with 100 ml bottle of balsamic

Vetro, Bamboo | Glass, Bamboo

☐ ☐ ☐ ☐ 7,5 x 25,5 x 5 cm



.00



79077
Baltiysk

Candela profumata alla vaniglia. Contenuta in piccolo barattolo in metallo con finestra trasparente. | Vanilla fragrance aromatic candle. Presented in an original metallic jar with transparent window.

Metallo | Metal

☐ ☐ ☐ ☐ Ø 6,3 x 3 cm



79012
Doro

Candela con coperchio trasparente | Candle in a tin with a clear lid

Metallo | Metal

☐ ☐ ☐ ☐ Ø 6 x 4,2 cm



79114
Corbola



Set profumazione 2 in 1 composto da diffusore da 50ml con 4 bastoncini e candela in cera profumata da 50gr. Disponibile nelle profumazioni bacca, muschio o melograno nero | 2-in-1 fragrance set consisting of 50ml diffuser with 4 sticks and 50gr scented wax candle. Available in berry, musk or black pomegranate scents

Vetro | Glass

☐ ☐ ☐ ☐ Diffuser: 4,8 x 6,8cm / Candle: 5,1 x 6,2cm



SCENT DIFFUSER AND HUMIDIFIER

With multicolored LED. 130 ml capacity. Includes USB charging cable.



26438
Bonamico



Diffusore di profumo umidificante a vaporizzazione continua con LED multicolore. Capacità 130ml. Include cavo di ricarica USB. Fornito in confezione dal design eco. | Humidifying continuous vaporization scent diffuser with multicolored LED. 130 ml capacity. Includes USB charging cable. Supplied in eco design packaging.

Plastica | Plastic

9,5 x Ø 10 cm



26545
Radon



Umidificatore con parte superiore effetto legno, capacità 250ml. | Abs humidifier with top in wood look

Abs | Abs

Ø 8 x 10 cm



26546
Tabel

Umidificatore con luce e umidificazione silenziosa. Capacità 320ml, cavo usb incluso. | 320 ml capacity humidifier with lights and silent humidification

Abs | Abs

Ø 7 x 14,5 cm





79098
Biancospino



Scatola di cartone con 35 coni d'incenso, profumo di legno di sandalo e porta coni. | Cardboard box with 35 sandalwood scent incense cones and support.

Incenso | Incense
Ø 7 x 5,5 cm



.00
SANDALWOOD
SCENT



BAMBOO



.11



34043
Bonifica



Stazione meteo digitale multifunzione. Orologio, sveglia, temperatura interna, igrometro. | Digital multi-functional weather station. Functions: Clock, Alarm, In-doors Temperature, Hygrometer.

Bamboo | bamboo
8,5 x 12 x 6 cm



BAMBOO



.11



32000
Gitano



Stazione meteorologica con sensore di temperatura e umidità. Funzione calendario e sveglia. Supporto posteriore regolabile e pieghevole. Alimentazione con batteria (2xAAAA non include) | Weather station with bamboo front. With temperature and humidity sensor. Calendar and alarm function. Adjustable and folding rear holder. Battery powered (2xAAAA not included).

Bamboo | bamboo
13x13x2,4

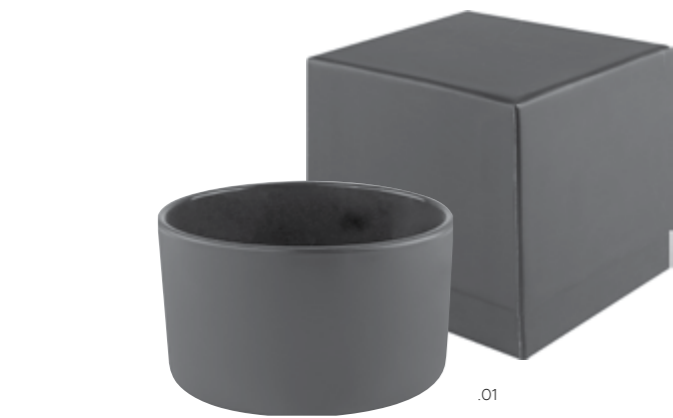

.01



79115
Cordignano



Diffusore di profumo fornito con 10 pietre bianche di vetro e una bottiglietta di olio essenziale di lavanda da 10ml. | Perfume diffuser supplied with 10 white glass stones and a 10ml bottle of lavender essential oil.

Pietra, Vetro, Olio profumato, Cartoncino | Stone, Glass, Perfumed oil, Cardboard
8,8 x 5,1 cm



10 WHITE
GLASS STONES

LAVENDER
ESSENTIAL OIL





MADE OF BAMBOO

.00



38055
Armeria maritima



Calendario perpetuo da tavolo in bambù. Formato da supporto e quattro blocchi incisi | Perpetual table calendar made of bamboo, formed of one stand and four engraved blocks.

Bambù | bamboo
[] 13,6 x 4,6 x 4,9 cm



MADE OF CORK

.11



38061
Lonigo



Calendario perpetuo contiene 4 cubi e una base rettangolare | Perpetual calendar contains 4 cubes and a rectangular base

Sughero | Cork
[] 13,5 x 6 x 4 cm



.05 .08 .01 .04



36007
Cornedo



Orologio da parete con lancette fluorescenti. | Wall clock with fluorescent hands.

Abs | Abs
[] 3,5 x Ø 28 cm



FLUORESCENT HANDS



.01



34004
Frido

Orologio da tavolo, fornito con vari quadranti personalizzabili, batterie escluse | Table clock with different dials, customizable. Batteries not included

Plastica | Plastic
[] 9,5 x 9,8 x 3,4 cm



.21



26144
Baltimora

Lavagna luminosa con hub usb sul retro e funzione orologio. | Glowing slate with USB (USB hub) and watch.

Plastica | Plastic
[] 14,5 x 12,5 x 3,9 cm

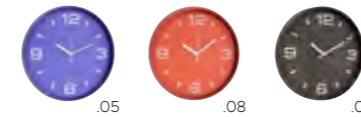

.05 .08 .01



36029
Crossandra

Orologio da parete con movimento al quarzo. Scocca smontabile per una facile personalizzazione interna. | Wall clock. Demountable clock frame for personalisation

Plastica | Plastic
[] Ø 30



.23 .08 .32



36030
Recha

Orologio da parete, batterie escluse | Wall clock, excl. batteries

Plastica, Vetro | Plastic, Glass
[] 30 x 30 x 5 cm





Food and Beverage

Nel capitolo Food & Beverage si possono trovare soluzioni promozionali come bottiglie d'acqua, snack, barattolini di caramelle e liquirizie, ma ancora frigoriferi e altri prodotti da personalizzare a vostro completo piacimento.

In the Food & Beverage chapter you can find promotional solutions such as water bottles, snacks, candies and liquorice boxes, but also refrigerators and much more, all to be customized as you like!

Food and Beverage

CUSTOM WATER BOTTLES FOR BUSINESSES OR EVENTS

High Quality Water



Verifica modelli e disponibilità sul sito web !
Check all the available models on our website!

CANDIES TO PROMOTE YOUR BRAND

Soft or chewy candies, lollipops and much more ..



CARAMELLE CON IL TUO LOGO

Scegli la tua caramella preferita

CANDY WITH YOUR LOGO

Choose your favourite candy



Verifica modelli e disponibilità sul sito web !
Check all the available models on our website!

PASTRIES AND CHOCOLATES FOR YOUR BRAND



PASTRIES AVAILABLE LIST

Mini biscuits, magdalena with chocolate, macarons and much more ...

CHOCOLATES AVAILABLE LIST

Round chocolates in flowpack, neapolitan chocolates, chocolate candies and much more ...



SUGAR SACHETS

Disponibili in busta trasparente, bianca, avana o PMS

Available in transparent, white, brown or PMS sachet



Verifica modelli e disponibilità sul sito web !
Check all the available models on our website!

Dining and Drinkware

Borracce, bottiglie, termos, tazze,
tazzine da caffè, lunch box e posate.
Scegli i nostri articoli ecologici e
personalizzali con il tuo logo.

Water bottles, thermos, coffee cups,
lunch boxes and cutlery. Choose our
eco-friendly items and personalize
them with your logo.

Dining

and

Drinkware





.00



82057
Foraker



Set posate. Include cucchiaio, coltello e forchetta, forniti in una pouch in cotone | Cutlery set made of bamboo. Includes spoon, fork and knife, presented in a cotton pouch with drawstring closure.

Bamboo | bamboo

📏 6,5 x 22 x 1 cm



Metalide



STAINLESS STEEL

.01



82066
Aglaia

Set di posate in acciaio inox. Include forchetta, coltello e cucchiaio. | Cutlery set made of stainless steel. Fork, spoon and knife included.

Acciaio Inossidabile | Stainless steel

📏 21 x 6 cm



.01



82069
Piombo



Set di posate composto da cucchiaio, forchetta e coltello, pieghevoli. Fornito in una pouch. | Stainless steel cutlery set of folding spoon, fork and knife

Acciaio inox, Pouch: RPET 600D | Stainless steel, Pouch: RPET 600D

📏 Bag: 8 x 11,5 cm / Cup: 15,5 cm



.17

.23



75006
Jorn

Contenitore porta pranzo, capacità 1000ml. Con finitura semitrasparente, interno con due scomparti e coperchio con scomparto per le posate (forchetta e coltello inclusi). | 1000ml capacity lunch box in PP material. With translucent body, inside with two compartments and cutlery holder cover -including knife and fork.

Plastica PP | PP plastic

📏 15,5 x 6 x 22,5 cm



BOROSILICATE GLASS

.21



75054
Forsizia

Porta pranzo in vetro borosilicato, capacità 1 L | Lunch Box in borosilicate glass with 1 L capacity

Vetro Borosilicato | Borosilicate glass

📏 20,2 x 6,7 x 15,2 cm



BAMBOO LID

GLASS

.00



74188
Buoni



Porta pranzo con capacità di 700 ml. In vetro, con un coperchio in bambù lucido. Include fascia di chiusura con forchetta, cucchiaio e coltello. | Lunch box with 700 ml capacity. Made of glass, with a polished bamboo lid, including a rubber band. Includes safety band with fork, spoon and knife

Vetro, Bamboo | Glass, Bamboo

📏 17,2 x 6,7 x 12,7 cm



BAMBOO LID

GLASS

.11



74204
Cachi



Contenitore pranzo in vetro, con coperchio in bambù e fascia in silicone per la chiusura. | Glass lunch box with bamboo lid and silicone tightening strap.

Vetro, Bamboo | Glass, Bamboo

📏 20 x 15 x 6 cm



BOROSILICATE

BOROSILICATE

LUNCH BOX

Made of 100% compostable PLA, BPA free. 1L capacity, including safety belt with fork, spoon and knife.



PLA 100% COMPOSTABLE 



74242
Nuca

Contenitore per il pranzo realizzato in PLA 100% compostabile senza BPA. Capacità 1L. Con fascia elastica con forchetta, cucchiaio e coltello. | Lunch box made of 100% compostable PLA, BPA free. 1L capacity, including safety belt with fork, spoon and knife.

PLA 100% Compostabile | PLA 100% Compostable

 19,1 x 7,4 x 11,8 cm 



.02



74228
Codula

Contenitore per il pranzo con coperchio. Capacità 700ml. Con fascia elastica con forchetta, coltello e cucchiaio. | Lunch Box with bamboo lid. Capacity 700ml. Including an elastic band with fork, knife and spoon.

PP, Bamboo | PP, Bamboo

 16,5 x 8 x 11,2 cm



74227
Cino

Contenitore per il pranzo in con coperchio. Due scomparti capacità 700ml. Con fascia elastica con forchetta, coltello e cucchiaio. | Lunch Box with bamboo lid. 2 compartments capacity 700ml. Including an elastic band with fork, knife and spoon.

PP, Bamboo | PP, Bamboo

 18,7 x 12,1 x 10,6 cm



74255
Cubebe

Portapanzo con coperchio in bambù. Comprende le posate fissate tramite una fasce elastiche. | Lunchbox with bamboo lid. Comes with cutlery secured by an elastic band.

Acciaio Inossidabile, Bamboo | Stainless Steel, Bamboo

 17 x 6 x 13 cm



.32



800 ML

BAMBOO LID



74248
Ginseng

Porta pranzo con coperchio in bambù e fascia di chiusura in poliestere. | Lunch box with bamboo lid and tightening strap in polyester.

Acciaio Inossidabile, legno | Stainless steel, wood

18,1 x 13,5 x 6,7 cm



.32



STAINLESS STEEL



74260
Natasha

Lunch box con sistema di chiusura con fibbie laterali. | Lunch box with fastening side clips.

Acciaio Inossidabile | Stainless steel

17,5 x 12 x 6 cm



.32



800 ML

BAMBOO LID



74259
Natalia

Porta pranzo con coperchio in bambù e sistema di chiusura con fibbie laterali. | Lunch box with bamboo lid and side buckle closure system.

Acciaio Inossidabile, Bamboo | Stainless Steel, Bamboo

18 x 13,5 x 6,7 cm



.32



STAINLESS STEEL



74207
Agave americana

Lunch box in acciaio inox, chiusura laterale con fibbie. Capacità 1,3L. | Lunch box made of 34 stainless steel with fastening side clips. 1,3 L capacity.

Acciaio Inossidabile | Stainless steel

19,4 x 13,6 x 7 cm



.32



1L

BAMBOO LID



74257
Curio

Porta pranzo con coperchio in bambù. Sistema di chiusura con fibbie laterali. | Lunch box with bamboo lid. Closing system with side buckle.

Acciaio Inossidabile, Bamboo | Stainless Steel, Bamboo

19,4 x 13,1 x 6,8 cm



.32

LUNCH BOX

Lunch box made of 34 stainless steel with fastening side clips





.02



74251
Calcio

Portapanzo con uno scomparto in PP, posate incluse, fissate con fascia elastica. Il coltello e la forchetta sono inclusi e sono realizzati con lo stesso materiale PP. | Lunch box with one compartment, cutlery included and secured with elastic band.

PP | PP

16 x 11 x 5 cm



.02



82068
Pimento

Posate in PP. Il coltello, il cucchiaio e la forchetta sono contenuti in un astuccio di PP | PP Cutlery. The knife, spoon and fork are included in a PP case.

PP | PP

5 x 20 cm



.02



74252
Creola

Tazza riutilizzabile in PP, dal design semplice ma classico. | Reusable Mug, in this simple yet classic design.

PP | PP

10 x 8,5 cm



.02



74253
Cripto

Tazza riutilizzabile in PP con cucchiaio. | Reusable PP cup with spoon. Enjoy your coffee, tea or hot chocolate in this mug with a simple yet classic design suitable for everyday use.

PP | PP

11 x 10 cm



Plastica riciclata

Recycled plastic

L' R-PET viene creato riciclando materie plastiche precedentemente utilizzate come materiali di imballaggio. Questi includono bottiglie di plastica, per esempio. Una volta raccolto, viene smistato e pulito, dopodiché viene trasformato in R-PET, che può quindi essere utilizzato per nuovi imballaggi. Questo è approvato a livello federale e significa effettivamente che puoi dare a ogni bottiglia una nuova vita.

R-PET is created by recycling plastics that were previously used as packaging materials. These include plastic bottles, for instance. Once collected, it is sorted and cleaned, after which it is transformed into R-PET, which can then be used for new packaging. This is federally approved and effectively means that you can give each bottle a new lease of life.



.01 .21 .23 .07 .04 .08

RECYCLED PLASTIC



600 ML



52171
Berto

Borraccia senza BPA. Tappo a vite in acciaio inox, con lanyard per il trasporto. | Bottle BPA-free. Stainless steel screw cap, with transport lanyard.

RPET | RPET

21 x 6,5 cm





ALUMINIUM BOTTLES

Perchè scegliere l'alluminio?

L'alluminio è notevole per la sua bassa densità e la sua capacità di resistere alla corrosione attraverso il fenomeno della passivazione. L'alluminio non è tossico come i metalli pesanti. È classificato come non cancerogeno dal dipartimento della salute e dei servizi umani.

- Peso leggero
- Protezione UV
- Resistente alla corrosione
- Non magnetico
- Non combustibile
- Riciclabile

Why choose Aluminium?

Aluminium is remarkable for its low density and its ability to resist corrosion through the phenomenon of passivation. Aluminium is not as toxic as heavy metals.

It's classified as a non-carcinogen by the United States Department of Health and Human Services.

- Light Weight
- UV Protection
- Corrosion Resistant
- Non - Magnetic
- Non - Combustible
- Recyclable



.32



52614
Lana

Borraccia con chiusura a vite, modello bottiglia di birra con moschettone | Bottle with screw closure, beer bottle model with carabiner. Metallic finishing

Alluminio | Aluminum

☞ Ø 7,5 x 25,5 cm

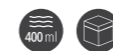

.32



52113
Gusau

Borraccia con tappo a vite, moschettone e portachiavi | Bottle with screw cap, carabiner and keyring

Alluminio | Aluminum

☞ Ø 7 x 26 cm

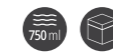

.01



52265
Laghi

Borraccia in alluminio con tappo in plastica, capacità 500ml | Drinking bottle with aluminium body and plastic lid 500ml

Alluminio | Aluminum

☞ Ø 6,6 x 20,5 cm



NEW



.01 .02 .32 .08 .17 .05 .70 .19 .06 .60



.08 .04 .01 .05



.02 .01 .32 .05 .07 .08 .19



.02 .01 .32 .05 .17 .07 .08 .04 .19 .06



.04 .02 .05 .06 .01 .08

MATT FINISH

750 ML



GLOSS FINISH

750 ML



GLOSS FINISH

500 ML



GLOSS FINISH

400 ML



GLOSS FINISH

330 ML



 SUBLIMATION COATING
ITEM 52136.02

 SUBLIMATION COATING
ITEM 52136.02

 SUBLIMATION COATING
ITEM 52098.02

 SUBLIMATION COATING
ITEM 52102.02



52014
Salzburg

Borraccia con tappo a vite e moschettone in metallo. | Bottle with screw-on safety cap and metal carrying carabiner.

Alluminio | Aluminum

Ø 7 x 24 cm



52632
Ente

Borraccia, finitura lucida, con tappo a vite. Con moschettone e anello in metallo nel tappo. | Bottle gloss finish with screw cap. Includes carabiner and key ring on the cap.

Alluminio | Aluminum

Ø 7 x 24 cm



52056
Tjena

Borraccia con finitura lucida. Tappo a vite e moschettone in metallo. | Bottle with aluminium finishing body. With screw-on safety cap and metal carrying carabiner.

Alluminio | Aluminum

Ø 7 x 20 cm



52110
Alma

Borraccia con finitura lucida. Tappo a vite e moschettone in metallo. | Bottle with shiny finishing. With screw-on safety cap and metal carrying carabiner.

Alluminio | Aluminum

Ø 6,6 x 17,5 cm



52527
Chinisia

Bottiglia con tappo a vite con laccetto. Con pouch in fibra di bambù. | Bottle with shiny finishing. With screw-on safety cap and metal carrying carabiner.

Alluminio | Aluminum

Ø 6,6 x 15 cm



The carabiners of these products may vary between silver and the same color of the bottle according to arrivals
I moschettoni di questi prodotti possono variare tra silver e nella medesima tonalità della borraccia secondo gli arrivi

The carabiners of these products may vary between silver and the same color of the bottle according to arrivals
I moschettoni di questi prodotti possono variare tra silver e nella medesima tonalità della borraccia secondo gli arrivi



.02



.02



.02



750 ML



500 ML



400 ML



52136
Saetta

Borraccia con tappo a vite, moschettone e anello. Con finitura speciale per la sublimazione | Bottle with screw-on safety cap, carabiner and key ring. With special finish for sublimation printing

Alluminio | Aluminum

17 x 7,3 x 24,5 cm



52098
Svalnäs

Borraccia con tappo a vite, moschettone e anello. Con finitura speciale per la sublimazione. | Bottle with screw-on safety cap, carabiner and key ring. With special finish for sublimation printing.

Alluminio | Aluminum

17 x 7 x 20 cm



52102
Svalnäslo

Borraccia particolarmente adatta per la sublimazione. Tappo a vite e moschettone | Bottle especially designed for sublimation printing. With screw-on safety cap and metal carrying carabiner.

Alluminio | Aluminum

17 x 6,6 x 17,5 cm



BAMBOO



400 ML

.32



52218
Lisa



Bottiglia singolo strato con tappo a vite in bambù e moschettone. | Single layer bottle with bamboo screw cap and carabiner.

Acciaio Inossidabile | Stainless steel

17 x Ø 6 cm



BAMBOO



750 ML

.32



52219
Marshall



Bottiglia singolo strato con tappo a vite in bambù e moschettone. | Single layer bottle with bamboo screw cap and carabiner.

Acciaio Inossidabile | Stainless steel

24,5 x Ø 7 cm





.02 .01 .03 .06 .19 .08 .23



52142
Azelio

Borraccia con corpo in finitura solida. Tappo con beccuccio a scomparsa e maniglia per il trasporto. | Bottle with body in solid finish. Cap with retractable nozzle and carry strap.

Alluminio, PP | Aluminum, PP

22,1 x Ø 7,3 cm



.23 .02 .08 .19



52530
Corace

Borraccia singola parete con tappo a vite coordinato | Bottle with screw closure and matching handle

Alluminio | Aluminum

Ø 6,6 x 22 cm



.08 .23 .32 .01 .02



52241
Valbelluna

NEW

Borraccia singola parete, finitura lucida, tappo a vite con pratico manico integrato. Imboccatura da 4.2cm di diametro. | Single walled bottles, glossy finish, screw cap with practical integrated handle. 4.2cm diameter mouthpiece.

Alluminio | Aluminum

Ø 6,7 x 21 cm



.08 .23 .32 .01 .02



52242
Villafranca

NEW

Borraccia singola parete, finitura lucida, tappo a vite con pratico manico integrato. Imboccatura da 4.2cm di diametro. | Single walled bottles, glossy finish, screw cap with practical integrated handle. 4.2cm diameter mouthpiece.

Alluminio | Aluminum

Ø 7,4 x 25,1 cm



4.2 CM DIAMETER

ALUMINIUM BOTTLE

Bottle with screw top. Matt finishing



.32 .01 .02 .19 .08 .23



52470
Cixerri

Borraccia con tappo a vite. Finitura opaca | Bottle with screw top. Matt finishing

Alluminio | Aluminum

Ø 6,5 x 21,5 cm

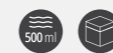



SINGLE WALL

.02



52637

Polly

Borraccia singola parete con tappo a vite. Finitura speciale per la sublimazione. | Single wall water bottle with screw cap. Special sublimation finish

Alluminio | Aluminum

Ø 6,5 x 21,5 cm



52528

Cixerri plus

Borraccia con tappo a vite. Finitura opaca | Bottle with screw top. Matt finishing

Alluminio | Aluminum

Ø 6,5 x 23,5 cm



.01

.08

.19

.23



.01

.23

.19

.32

.08



.08

.19

.02

.32

.01

.23



.02

.01

.23

.19

.32

.08



.01

.02

.08

.23



.32

.08

.05

.01

.19



52529

Combin

Borraccia con tappo ad apertura a vite, tappo in plastica con laccio in silicone. | Bottle with screw closure, plastic top and silicon lace.

Alluminio | Aluminum

Ø 6,6 x 19 cm



52076

Bengkulu

Borraccia sportiva, tappo a vite con coperchio. Con laccettino corto. | Sports bottle, screw on cap with lid. With short carrying belt.

Alluminio | Aluminum

Ø 6,6 x 25 cm



52236

Perarolo

Bottiglia con tappo colorato con pratico laccetto per il trasporto. | Bottle with colored cap with practical carrying strap.

Alluminio riciclato | Recycled aluminum

22,5 x 6,6 cm

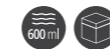

52237

Posina

Bottiglia in alluminio riciclato, corpo colorato, tappo silver. | Recycled aluminum bottle, colored body, silver cap.

Alluminio riciclato | Recycled aluminum

23,5 x 6,6 cm

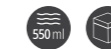

52238

Rossano

Borraccia con moschettone | Drinking bottle with carabiner

Alluminio riciclato | Recycled aluminum

17,5 x 6,6 cm



THERMAL BOTTLE 450 ML

Stainless steel and bamboo details. Lid with double function, handle and mobile stand.



52235
Musile



Thermos doppia parete con dettagli in bambù. Tappo con maniglia a doppia funzione, che può essere utilizzato come supporto per smartphone. | Double wall thermos with bamboo details. Cap with dual function handle, which can be used as a smartphone holder.

Acciaio Inossidabile | Stainless steel

22 x 7 cm



.02 .32 .01



.11



DIGITAL TOUCH THERMOMETER



52181
Spatifillo

Thermos doppia parete. Indicatore di temperatura. Include accessorio filtrante. | Double-walled thermo bottle. Liquid temperature indicator. Includes strainer.

Acciaio Inossidabile | Stainless steel

Ø 6,5 x 23 cm



DIGITAL TOUCH THERMOMETER



52234
Mezzane



Thermos a doppia parete con filtro per il tè. Termometro digitale touch sul tappo. | Double wall thermos with tea filter. Digital touch thermometer on the cap.

Acciaio Inossidabile | Stainless steel

23,5 x 6,5 cm





.02 .01 .32

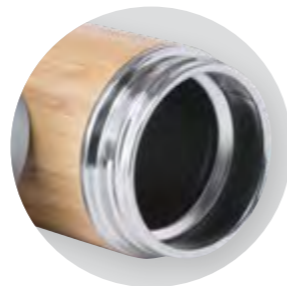

52177 **Agapanto**

Thermos doppia parete in acciaio e base in sughero, con infusore per il tè. | Double wall thermos bottle made of 34 steel, with filter and cork base.

Acciaio Inossidabile | Stainless steel

24,5 x Ø 6,4 cm



52077 **Benina**

Bottiglia di alta qualità con corpo in bambù e interno in acciaio inox. Tappo a vite in acciaio inox. | High quality bottle with body in bamboo and inside in stainless steel. Safety screw-on cap doser in stainless steel.

Acciaio Inossidabile, Bamboo | Stainless Steel, Bamboo

Ø 6,9 x 24,5 cm



52183 **Susanna**

Thermos doppia parete con finitura in bambù. Include accessorio filtrante. | Double-walled thermos with bamboo outer finish. Includes strainer.

Acciaio Inossidabile, Bamboo | Stainless Steel, Bamboo

7 x 21 cm



.11



74184 **Birillo**

Tazza con corpo in una in bambù e acciaio inossidabile a doppia parete per una migliore e più duratura conservazione della temperatura. Con tappo originale a dispenser. | Mug with body in combination of bamboo and double-walled stainless steel for better and longer-lasting preservation of temperature. With dosage cap.

Acciaio Inossidabile, Bamboo | Stainless Steel, Bamboo

10,5 x Ø 8 cm



.11



52078 **Benna**

Tazza con tappo con dosatore di sicurezza. | Cup with security dosing lid

Acciaio Inossidabile, Bamboo | Stainless Steel, Bamboo

Ø 8,2 x 17,5 cm



.11



52120 **Atella**

Thermos con coperchio con tazza integrata. Doppia parete. Con laccettino. | Bamboo thermos, double wall. With mug integrated in the cap. With carrying belt.

Acciaio Inossidabile, Bamboo | Stainless Steel, Bamboo

25,5 x Ø 6,5 cm



.32



52169 **Benjamin**

Borraccia con tappo in bambù con lanyard per il trasporto. Senza BPA. | Bottle with bamboo cap with carrying strap. BPA free.

Acciaio Inossidabile, Bamboo | Stainless Steel, Bamboo

21,7 x Ø 6,3 cm

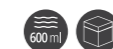



500 ML

.02 .01 .32



52194
Moscovio



Bottiglia termica doppia parete con base in sughero. Tappo a vite. | Double Wap-ped Thermal Bottle with Cork Base.

Acciaio Inossidabile | Stainless steel

∅ 7,1 x 27 cm



600 ML

.01 .02



52483
Sebastian



Bottiglia termica doppia parete, con tappo a vite con finitura in finto sughero. Finitura opaca. | Double wall thermal bottle, with screw cap with faux cork finish. Matte finish.

Acciaio Inossidabile | Stainless steel

∅ 7 x 26 cm



.23 .32 .08



.01 .32



650 ML



800 ML



500 ML

.02



52202
Palladio



Bottiglia doppia parete con tappo a vite. Particolarmente adatta alla sublimazio-ne. Sconsigliato l'inserimento di liquidi acidi o effervescenti. | Double-walled bottle 500ml with screw-on bamboo stopper.

Acciaio Inossidabile, Bamboo | Stainless Steel, Bamboo

∅ 7,5 x 23 cm



500 ML

.01



52188
Levistico



Bottiglia doppia parete con tappo a vite. Sconsigliato l'inserimento di liquidi acidi o effervescenti. | Double-walled bottle 500ml with screw-on bamboo stopper

Acciaio Inossidabile, Bamboo | Stainless Steel, Bamboo

∅ 7,5 x 23 cm



52172
Beta



Borraccia con tappo a vite in bambù. | Bottle with bamboo screw-on cap.

Acciaio Inossidabile | Stainless steel

∅ 7,3 x 20,5 cm

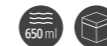

52069
Benetutti



Bottiglia con tappo a vite con inserto in legno e piccolo manico vintage. | Bottle with security screw-on cap with wooden detail and vintage, carrying handle.

Acciaio Inossidabile | Stainless steel

∅ 7,2 x 24,2 cm





52581
Eleutero

Elegante bottiglia con tappo a vite coperto in bambù, con piccolo manico vintage. | Elegant bottle with screw-on cap covered with bamboo, with vintage carrying handle.

Acciaio Inossidabile, Bamboo | Stainless Steel, Bamboo

Ø 7,2 x 20,5 cm



52184
Gloxinia

Bottiglia con tappo ricoperto in bambù. Doppia parete per mantenere il caldo e il freddo. Finitura speciale per la sublimazione. | Bottle with cap covered with bamboo. It has a double wall which allows to keep the cold and heat. Special for sublimation.

Acciaio Inossidabile | Stainless steel

Ø 7,2 x 20,5 cm



THERMAL BOTTLE

With old milk bottle handle.



52221
Colceresa



Bottiglia termica doppio strato, con tappo a vite in bambù. È caratterizzato da un'originale impugnatura che ricorda le vecchie bottiglie di latte. | Double layer thermo bottle, with bamboo screw cap. It is characterized by an original handle reminiscent of old milk bottles.

Acciaio Inossidabile | Stainless steel

22,5 x Ø 7 cm

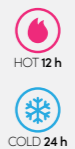



52268

Vicenza

NEW

Bicchieri in acciaio inossidabile con finitura in rame galvanizzato. 550ml | Stainless steel tumbler with galvanized copper finish

Acciaio Inossidabile | Stainless steel

10 x Ø 9,3 cm



.16



52269

Vigonza

NEW

Bicchieri termico in acciaio inossidabile con finitura in rame galvanizzato | Thermal tumbler in stainless steel with galvanized copper finish

Acciaio Inossidabile | Stainless steel

12 x Ø 8,9 cm



.16



52267

Veronella

NEW

Borraccia in acciaio inossidabile con finitura in rame galvanizzato | Stainless steel bottle with galvanized copper finish

Acciaio Inossidabile | Stainless steel

Ø 7,3 x 22,5 cm



.16



52266

Venezze

NEW

Borraccia in acciaio inossidabile con finitura in rame galvanizzato | Stainless steel bottle with galvanized copper finish

Acciaio Inossidabile | Stainless steel

Ø 7,4 x 26,5 cm

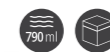

.16



STAINLESS STEEL BOTTLES COLLECTION



Perché usiamo l'ACCIAIO?

È usato perché è:

- non tossico
- non assorbente
- resistente agli acidi
- stampabile con incisione laser

Why do we use STEEL?

It's used because it is:

- non-toxic
- non-adsorptive
- acids resistance
- laser engravable

Perché scegliere l'acciaio inossidabile?

L'acciaio inossidabile è particolarmente noto per la sua resistenza alla corrosione. Le aggiunte di molibdeno aumentano la resistenza alla corrosione nella riduzione degli acidi e contro l'attacco corrosivo nelle soluzioni di cloruro. Pertanto, esistono numerosi gradi di acciaio inossidabile con diversi contenuti di cromo e molibdeno per adattarsi all'ambiente che la lega deve sopportare. La resistenza alla corrosione e alle macchie, la bassa manutenzione e la lucentezza familiare rendono l'acciaio inossidabile un materiale ideale per molte applicazioni, in particolare cibi e bevande.



Why choose stainless steel?

Stainless steel is most notable for its corrosion resistance. Additions of molybdenum increases corrosion resistance in reducing acids and against pitting attack in chloride solutions. Thus, there are numerous grades of stainless steel with varying chromium and molybdenum contents to suit the environment the alloy must endure. Resistance to corrosion and staining, low maintenance, and familiar luster make stainless steel an ideal material for many applications especially food and drink.





630 ML



700 ML



630 ML



52115
Dili

Borraccia con finitura opaca. Tappo a vite. | Bottle with metal screw-on lid. Matt finish.

Acciaio Inossidabile | Stainless steel

Ø 6,7 x 24,5 cm

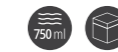

52506
Dropper

Borraccia da 630ml in acciaio inox con finitura opaca. Tappo a vite. Fornita in confezione singola. | Bottle with screw-on cap. Shiny finish

Acciaio Inossidabile | Stainless steel

Ø 7 x 26 cm



52535
Curone

Borraccia singola parete con finitura lucida, con tappo a vite. | Thermic bottle, single wall

Acciaio Inossidabile | Stainless steel

Ø 71 x 25,5 cm



52149
Lamar

Borraccia con tappo a vite. Finitura opaca. | Bottle with screw cap. Matt finish.

Acciaio Inossidabile | Stainless steel

Ø 71 x 25,5 cm



52070
Benevello

Borraccia con finitura opaca. Parete singola. Tappo colorato coordinato. | Bottle in matt colours. With safety lid in matching colour.

Acciaio Inossidabile | Stainless steel

Ø 7,4 x 25,7 cm

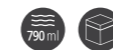



.23 .08 .02 .01



52170
Berta

Borraccia con corpo bicolore e finitura opaca. Tappo con impugnatura in gomma flessibile. | Bottle with two-colour body in matt finish. Screw cap with flexible rubber handle.

Acciaio Inossidabile | Stainless steel

24,7x Ø 7,5 cm



.02



.02



.02



700 ML



700 ML



500 ML



.02



52201
Nichel

Bottiglia termica doppia parete, con tappo a vite con laccettino per un facile trasporto. Particolarmente adatta alla sublimazione. | Double walled bottle, with screw cap with strap for easy transport. Especially suited for sublimation

Acciaio Inossidabile, silicone, PP | Stainless steel, silicone, PP

Ø 7 x 25,5 cm



.05

.01



52187
Laurenzio

Bottiglia termica doppia parete, con tappo a vite con laccettino per un facile trasporto. Particolarmente adatta alla sublimazione. | Double walled bottle with vacuum insulation, with lanyard for easy carrying

Acciaio Inossidabile, PP, Silicone | Stainless Steel, PP, Silicone

Ø 7 x 25,5 cm



52230
Vicentina



Bottiglia ideale per la sublimazione. | Ideal bottle for sublimation.

Acciaio Inossidabile | Stainless steel

25,7 x 7,1 cm



52111
Meldola



Bottiglia con corpo con finitura speciale per la sublimazione. Tappo a vite. | Bottle with body with a special finish for sublimation printing. With screw-on cap.

Acciaio Inossidabile | Stainless steel

Ø 6,5 x 24,5 cm

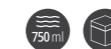

52207
Pancho



Bottiglia con finitura speciale per la sublimazione, con tappo a vite color silver. | Bottle with special finish for sublimation, with screw-on cap in silver colour.

Acciaio Inossidabile | Stainless steel

Ø 7 x 22 cm





.01 .02



52186
Lantano

Bottiglia termica doppia parete. Tappo a vite. Sconsigliato l'inserimento di liquidi acidi o effervescenti | Double wall thermal bottle. Screw cap.

Acciaio Inossidabile | Stainless steel

Ø 7,5 x 31 cm



750 ML

THERMAL BOTTLE

Stainless steel thermal bottle with safety stopper and double layer



.02

500 ML



.02

500 ML



52185
Rodrigo

Borraccia termica a doppia parete speciale per la sublimazione. | Thermal bottle with double wall, especial for sublimation.

Acciaio Inossidabile | Stainless steel

Ø 7,2 x 25,5 cm



52573
Duranno

Bottiglia a doppia parete con tappo a vite color silver. Finitura per sublimazione. | Double wall bottle with silver colored screw cap. Special finish for sublimation.

Acciaio Inossidabile | Stainless steel

6,7 x 24,5 cm



.01 .03 .02 .19 .08 .23 .05



52526
Morgan

Bottiglia termica doppio strato, con tappo a vite. Finitura opaca. | Double layer thermal bottle, with screw cap. Matte finish.

Acciaio Inossidabile | Stainless steel

Ø 7 x 26,5 cm

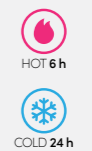

500 ML





850 ML
HOT 6h
COLD 24h



850 ML
HOT 6h
COLD 24h



500 ML
HOT 6h
COLD 24h

52231 **Selvazzano**

NEW

Bottiglia termica doppia parete. | Double wall thermal bottle.

Acciaio Inossidabile | Stainless steel

30,5 x 8 cm



52063 **Antea**

Bottiglia termica, doppio strato, finitura lucida. Con tappo a vite. | Thermal bottle in glossy finish. With screw-on cap.

Acciaio Inossidabile | Stainless steel

Ø 8 x 30,5 cm



52064 **Gordi**

Thermos doppio strato, con tappo di sicurezza. | Thermal bottle with safety stopper with double layers

Acciaio Inossidabile | Stainless steel

Ø 7 x 26,5 cm



Stainless steel can also have a second life



HOT 6h
COLD 24h

52225 **Abano**

ECO NEW

Bottiglia termica doppio strato realizzata in acciaio inox riciclato, tappo a vite. Sul collo della bottiglia è applicato un tag removibile che attesta che state effettuando un acquisto amico dell'ambiente. | Double layer insulated bottle made of recycled stainless steel, screw cap. A removable tag is applied to the neck of the bottle that certifies that you are making an environmentally friendly purchase.

Acciaio Inossidabile Riciclato | Recycled Stainless Steel

Ø 7 x 26,5 cm





THERMAL BOTTLE 350 ML
Made of stainless steel



COPPER VACUUM INSULATION



52246
Zenson

NEW

Borraccia doppio strato. Capacità 350ml. Imboccatura larga, Finitura satinata. Fornita in confezione singola | Double layer drinking bottle. Capacity 350ml. Wide mouth, satin finish. Supplied in single pack

Acciaio Inossidabile | Stainless steel

Ø 7,6 x 15,5 cm

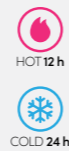

52196
Neodimio

Bottiglia termica doppia parete con isolamento in rame sottovuoto. Permette di mantenere a lungo il caldo e il freddo. | Double walled bottle with vacuum insulation.

Acciaio Inossidabile, Isolamento in Rame | Stainless Steel, Copper Insulation

Ø 7,4 x 22,5 cm



52182
Stapelia

Bottiglia termica a doppia parete con finitura in gomma. Tappo a vite coordinato. | Double wall bottle with rubber finish. Screw matching cap.

Acciaio Inossidabile | Stainless steel

7,5 x 22,5 cm





580 ML

SUBLIMATION COATING
ITEM 52223.02



.23 .01 .08 .02



52217
Codognè

NEW

Bottiglia termica doppia parete in acciaio inox. Tappo a vite. | Double walled stainless steel thermal bottle. Screw cap

Acciaio Inossidabile | Stainless steel

26 x Ø 6,90 cm



SUBLIMATION COATING
ITEM 52224.02



.02 .23 .01 .04 .06 .08



52215
Cogollo

NEW

Bottiglia finitura solida e tappo a vite. | Solid finish bottle and screw cap

Acciaio Inossidabile | Stainless steel

22,5 x Ø 7,40 cm



680 ML



580 ML



.02



.02



.02



680 ML



550 ML

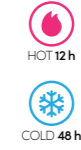

COPPER VACUUM INSULATION



52223
Cittadella

NEW

Bottiglia termica doppia parete in acciaio inox. Tappo a vite. Finitura speciale per sublimazione | Double walled stainless steel thermal bottle. Screw cap Special sublimation finish

Acciaio Inossidabile | Stainless steel

26 x Ø 6,9 cm

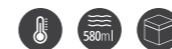

52224
Codevigo

NEW

Bottiglia finitura solida e tappo a vite. Finitura speciale per sublimazione. Fornita in confezione singola. | Solid finish bottle and screw cap Special sublimation finish. Supplied in a single pack.

Acciaio Inossidabile | Stainless steel

26 x Ø 6,9 cm

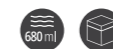

52229
Trevezuolo

NEW

Bottiglia termica. Doppia parete con isolamento sottovuoto in rame. | Thermal bottle. Double wall with copper vacuum insulation.

Acciaio Inossidabile | Stainless steel

22,5 x Ø 7,4 cm





.23 .05 .01 .08 .32 .31



.02



.23 .01 .08 .19 .32 .31



.05 .02 .01 .08 .19 .32



.02



HOT 12h



COLD 24h



HOT 6h



COLD 12h



HOT 12h



COLD 48h



COPPER VACUUM INSULATION



HOT 12h



COLD 48h



COPPER VACUUM INSULATION



HOT 12h



COLD 48h



COPPER VACUUM INSULATION



52179

Sempervivum

Bottiglia termica a doppia parete. Tappo a vite, finitura metallizzata. | Double-walled bottle. Screw cap, metal finish.

Acciaio Inossidabile | Stainless steel

☐ 7 x 26 cm



52180

Sofora

Bottiglia doppia parete. Finitura speciale per la sublimazione. | Double-walled bottle. Screw cap, special finish for sublimation.

Acciaio Inossidabile | Stainless steel

☐ 7 x 26 cm



52145

Azzu

Borraccia termica doppio strato con isolamento in rame sottovuoto. Permette di mantenere il caldo e il freddo più a lungo, raggiungendo rispettivamente le 12 e le 48 ore di tenuta. | Thermal bottle, with double layer and copper vacuum insulation. It allows you to maintain heat and cold for a longer time, reaching 12 and 48 hours respectively.

Acciaio Inossidabile | Stainless steel

☐ 7 x 26,3 cm



52525

Cerami

Bottiglia termica con isolamento termico sottovuoto in rame. Doppia parete, tappo a vite. | Copper vacuum insulated thermal bottle. Double walled with screw on cap.

Acciaio Inossidabile, Rame | Stainless Steel, Copper

☐ 7 x 26,3 cm



52210

Newman

Bottiglia termica con isolamento termico sottovuoto in rame. Doppia parete, tappo a vite. Finitura speciale per la sublimazione. | Copper vacuum insulated thermal bottle. Double walled with screw on cap. Special finish for sublimation.

Acciaio Inossidabile | Stainless steel

☐ 7 x 26,3 cm





.02 .01 .08 .23 .19 .16



52192
Litio

Bottiglia termica doppia parete con isolamento in rame sottovuoto. Permette di mantenere a lungo il caldo e il freddo. | Double wall thermal bottle with vacuum copper insulation.

Acciaio Inossidabile, Isolamento in Rame | Stainless Steel, Copper Insulation

28,5 x 7,3 cm



.01 .08 .23



52228
Spresiano

NEW

Bottiglia termica doppia parete | Double wall thermal bottle

Acciaio Inossidabile | Stainless steel

23,5 x 6,8 cm



.01 .03 .05



.02



.19 .18 .16



52197
Neon

Borraccia termica doppia parete con tappo a vite con finitura silver. Finitura opaca. | Double Walled water bottle with screw cap in silver finish. Matt finish.

Acciaio Inossidabile | Stainless steel

Ø 6,7 x 23,7 cm



52203
Nela

Bottiglia termica doppia parete con tappo a vite. Particolarmente adatta alla sublimazione. Sconsigliato l'inserimento di liquidi acidi o effervescenti. | Double wall bottle. Special for sublimation.

Acciaio Inossidabile | Stainless steel

Ø 6,7 x 17,8 cm



52190
Liquirizia

Bottiglia doppia parete. Sconsigliato l'inserimento di liquidi acidi o effervescenti. | Double Walled bottle with 350ml capacity.

Acciaio Inossidabile | Stainless steel

Ø 6,7 x 18 cm



THERMAL BOTTLE

Double wall with vacuum copper insulation.



HOT 6 h
COLD 15 h

.05 .01 .08



52073
Lis

Thermos finitura lucida. Con tappo che funge da tazza. | Thermos flask in glossy finish. With safety stopper/mug.

Acciaio Inossidabile | Stainless steel

Ø 7 x 24,5 cm



HOT 6 h
COLD 12 h

.32



52244
Erbé

Caraffa termica dal design originale, realizzata in acciaio inox doppia parete. | Thermal carafe with an original design, made of double wall stainless steel.

Acciaio Inossidabile | Stainless steel

Ø 12,5 x 20 cm



NEW



HOT 6 h
COLD 12 h

.32 .02 .01



52195
Mostarda

Bottiglia termica doppia parete con apertura con pulsante e chiusura di sicurezza. | Double wall thermal bottle with push button opening and safety closure.

Acciaio Inossidabile | Stainless steel

Ø 6,4 x 23 cm



HOT 6 h
COLD 15 h

.88 .32 .01 .85



52065
Dikili

Thermos con isolamento sottovuoto, con finitura opaca, con tazza integrata nel tappo. | Vacuum flask, matt finish, with integrated mug in cap.

Alluminio, Gomma | Aluminum, Rubber

Ø 7 x 26 cm



HOT 6 h
COLD 15 h

.32



52473
Marta

Thermos con tappo a vite che funge da tazza e pratico versatore. | Thermo bottle with safety dispenser and screw-on cap.

Acciaio Inossidabile | Stainless steel

Ø 6,1 x 26,3 cm



HOT 6 h
COLD 15 h

.32



52075
Carmen

Thermos con isolamento sottovuoto, con tazza integrata nel tappo. | Vacuum flask capacity 350ml with integrated mug in cap.

Acciaio Inossidabile | Stainless steel

Ø 8,1 x 18 cm



HOT 6 h
COLD 24 h

.32



52560
Dino

Borraccia doppia parete con tappo nero. | Double walled bottle with black cap.

Acciaio | Steel

Ø 6,7 x 24 cm





.02



.02

GLOSS FINISH



HOT 6h



COLD 15h



MATT FINISH



HOT 6h



COLD 15h

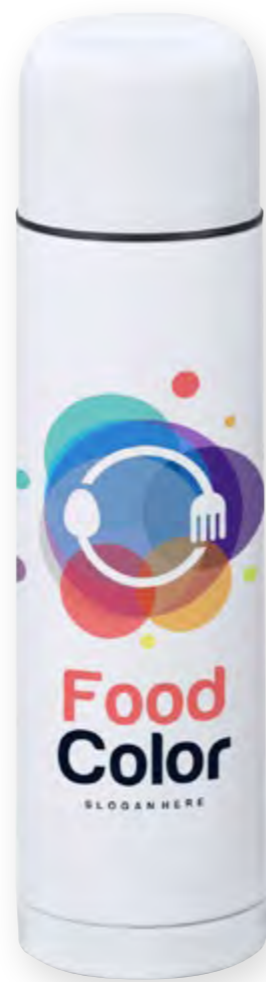

52112
Mele



Thermos con finitura esterna realizzata appositamente per la sublimazione. Tappo a vite. | Thermal bottle with outside with special coating, especially designed for sublimation printing. Screw on security lid.

Acciaio Inossidabile | Stainless steel

☐ 7 x 24,6 cm



52209
Patroclo



Thermos in acciaio inox, finitura speciale per la sublimazione. Con dispenser di sicurezza e tappo che funge da tazza. | Thermos flask. With safety dispenser and screw-on cap convertible in cup. Special finish for sublimation.

Acciaio Inossidabile | Stainless steel

☐ 7 x 24,6 cm



.32

175 ML



52083
Let

NEW

Fiaschetta in acciaio inox con chiusura di sicurezza anti perdita. | Stainless steel hip flask with anti-leak safety clasp.

Acciaio Inossidabile | Stainless steel

☐ 9,3 x 11,2 cm

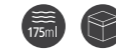

.11

160 ML



52211
Cologna

NEW

Fiaschetta in acciaio con rivestimento in bambù. Spessore della parete 4mm. | Steel hip flask with bamboo coating. Wall thickness 4 mm.

Acciaio Inossidabile, Bambù | Stainless Steel, Bamboo

☐ 11,2 x 9,3 x 21 cm





tritan™

Che cos'è il tritan?

Il tritano è un polimero ed il polimero è una sostanza formata dalla combinazione di diverse molecole identiche (monomeri) tra loro. È senza BPA e non contiene il bisfenolo A. È definito come materiale di nuova generazione perché presenta eccellenti caratteristiche quali: resistenza alle temperature e possibilità di essere lavato frequentemente.

È usato perché è:

- non tossico
- frequentemente lavabile
- resistente alle alte temperature
- senza il BPA
- stampabile

What is tritan ?

Tritan is a polymer which is a substance formed by the combination of several identical molecules (monomers) between them. It is BPA-FREE and it does not contain the toxic chemical Bisphenol A.

It is defined as a new generation material because it has excellent characteristics such as: resistance to temperatures, possibility of being washed frequently.

It's used because it is:

- non-toxic
- wash frequently
- resistance to high temperature
- BPA-FREE
- printable



.21



.21

.05



52520
Chiastolite

Bottiglia con finitura opaca, con tappo in acciaio inox. | Bottle made of tritan with matt finish, with a stainless steel cap.

Tritan, Acciaio Inox | Tritan, Stainless Steel

6 x 20,5 cm

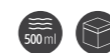

52512
Cavansite

Bottiglia con base e tappo a vite in acciaio inox. | Bottle with base and screw-on cap in stainless steel.

Tritan, Acciaio Inox | Tritan, Stainless Steel

7 x 26 cm

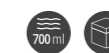



.03 .21 .23 .19 .08



.06 .08 .01 .23 .04 .02



.21



52107
Agro

Bottiglia trasparente con tappo con finitura gommata e laccetto | Transparent bottle with rubber finished top and grabbing string

Tritan | Tritan

☐ 7,5 x 27 cm



52160
Beato

Bottiglia. Tappo in tinta con maniglia di trasporto integrata, coordinata. | Bottle. Matching cap with in-built carry strap.

Tritan, PP, Silicone | Tritan, PP, Silicone

☐ 25,7 x 6,7 cm



52101
Fisolo

Bottiglia con tappo color silver | Bottle with silver coloured top

Tritan | Tritan

☐ 7,7 x 27 cm



BOROSILICATE



52232
Frassinelle



Bicchieri con effetto satinato colorato sfumato. Coperchio e cannuccia in bambù. | Glass with shaded colored satin effect. Bamboo lid and straw.

Vetro Borosilicato | Borosilicate glass

14 x 7,5 cm



NATURAL CORK



450 ML



52214
Colognola



Bicchieri con coperchio e pouch in sughero naturale, e cannuccia in bambù. | Tumbler with lid and pouch in natural cork, and bamboo straw.

Vetro Borosilicato, Bamboo, Sughero | Borosilicate glass, Bamboo, Cork

18 x Ø 6,80 cm



BOROSILICATE GLASS



BAMBOO LID AND STRAW

BOROSILICATE



.21



.11

500 ML



GLASS

JUTA

FINGER
GROCERIES



52143
Navi



Bottiglia con pouch in juta naturale e tappo in bambù con pratico laccettino per il trasporto. | Bottle with natural jute pouch and bamboo cap with practical carrying strap.

Vetro, Juta, Bamboo | Glass, Jute, Bamboo

22,5 x Ø 6,3 cm

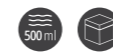

500 ML



GLASS

CORK



52074
Asia



Bottiglia con pouch in sughero naturale e tappo a vite in bambù, con pratico laccettino per il trasporto. | Bottle with natural cork pouch and bamboo screw cap, with practical carrying strap.

Vetro, Sughero, Bamboo | Glass, Cork, Bamboo

22,5 x Ø 6,3 cm



BOROSILICATE



.21



52233
Lendinara



Bottiglia doppia parete con tappo in bambù. Filtro per il tè incluso. | Double wall bottle with bamboo cap. Tea filter included.

Vetro Borosilicato | Borosilicate glass

23,9 x Ø 7 cm



52167
Bel



Borraccia di vetro con tappo di bambù e manico per il trasporto. | Glass bottle with bamboo cap and carrying strap in natural finishing.

Vetro, Bamboo | Glass, Bamboo

Ø 6,4 x 19,7 cm



.11



.01 .19 .08 .23 .02



.18 .08 .01 .23 .16 .02



.11



52205
Plutonio



Bottiglia con tappo in bambù e pouch in silicone colorato. | Glass bottle with bamboo cap and colored silicone case.

Vetro, Silicone | Glass, Silicone

Ø 6,7 x 23,1 cm

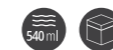

52108
Malgher



Bottiglia in vetro con tappo in bambù. Con guaina in silicone. | Bottle made of glass with bamboo cap. With silicon sheath

Vetro, Silicone | Glass, Silicone

Ø 6,5 x 22,5 cm

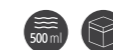

52072
Benidorm



Bottiglia, capacità 500ml, con tappo a vite | Bottle with screw-on cap made of natural bamboo wood.

Vetro | Glass

Ø 6,5 x 22 cm





52159
Ashton

Bottiglia con coperchio a vite in acciaio inox e laccettino per trasporto in colore grigio. | Bottle with screw cap in stainless steel and grey carry strap.

Vetro, Plastica, Acciaio Inox | Glass, Plastic, Stainless Steel

22 x Ø 6,3 cm

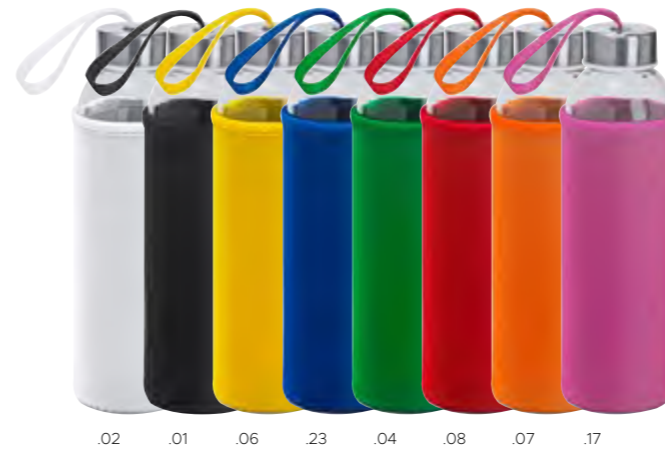

52175
Lamberto

Borraccia con pratica custodia in neoprene e laccettino per il trasporto dello stesso colore della custodia. | Bottle with practical neoprene pouch and carrying strap in the same color as the pouch.

Vetro | Glass

22 x Ø 6,7 cm



52503
Dragon

Bottiglia con pouch in neoprene. Con tappo a vite e laccetto per il trasporto. | Bottle with neoprene cover. With screw-on safety cap and carrying belt.

Vetro | Glass

Ø 6,4 x 19 cm



52178
Agrifoglio

Bottiglia in vetro con tappo in acciaio inossidabile. | Glass bottle with stainless steel cap.

Vetro, Acciaio Inox | Glass, Stainless Steel

26 x Ø 7,1 cm



52156
Battista

Bottiglia con corpo in vetro e tappo a vite. Include una pouch in softshell coordinata, con particolare laccetto per il trasporto. | Bottle with body manufactured in glass, with screw cap. Including matching color soft shell case, with carrying handle.

Vetro | Glass

16,2 x Ø 8,8 cm





52114
Gushi

Bottiglia con tappo a vite in metallo. | Bottle with metal screw-on lid.

Vetro | Glass

∅ 6 x 22 cm



52481
Yeron

Bottiglia con tappo in acciaio inox. | Bottle with stainless steel tap

Vetro Borosilicato, Acciaio Inox | Borosilicate glass, stainless steel

∅ 6,5 x 22,5 cm



A



52482
Febe

Bottiglia con tappo in acciaio inox. | Bottle made of glass with a stainless steel cap

Vetro, Acciaio Inox | Glass, Stainless Steel

∅ 7,5 x 31 cm



B



52104
Furiano

Bottiglia in vetro con tappo in metallo. | Bottle made of glass with metal cap.

Vetro | Glass

∅ 6,5 x 28 cm



C



52480
Anteo

Bottiglia con tappo in acciaio inox. | Bottle made of glass with a stainless steel cap

Vetro, Acciaio Inox | Glass, Stainless Steel

∅ 9,5 x 25,5 cm



NATURAL CORK



.21

CORK CAP



BOROSILICATE

NATURAL CORK



.21

CORK CAP



BOROSILICATE



52200
Nettuno

Bottiglia con tappo in sughero. | Bottle with cork cap
Vetro Borosilicato, Sughero | Borosilicate glass, Cork
Ø 7,5 x 16,5 cm



52198
Nepitella

Caraffa con coperchio. | Pitcher with lid.
Vetro Borosilicato, Sughero | Borosilicate glass, Cork
10 x 16 cm



52189
Limetta

Teiera con coperchio e filtro in metallo removibile. | Teapot with lid and removable filter.

Vetro Borosilicato, Bamboo | Borosilicate glass, Bamboo

Ø 13 x 12,4 cm



BOROSILICATE TEAPOT

Borosilicate teapot with removable metal filter and bamboo lid.



.21



BOROSILICATE



.17 .08 .05 .06 .01



.19 .05 .08 .21 .01



.08 .21 .05 .04



.07 .08



.06 .01 .02 .07 .17 .08 .04 .05



52001
Ryan

Borraccia con barra refrigerante. Tappo a vite con beccuccio a pressione. | Drinking bottle, with ice bar in the centre. Screw on cap with push-pull spout.

Plastica | Plastic

Ø 6 x 20 cm



52030
Atocia

Borraccia con tappo a vite e beccuccio a pressione. | Bottle with screw-on cap and safety dosing device.

PE | PE

Ø 7 x 11 cm



.06 .01 .02 .07 .08 .04 .05



.06 .01 .02 .07 .08 .04 .23



76051
Vintersaga

Bottiglia con tappo a vite in diversi colori. | Bottle with screw-on cap in different colours.

Plastica AS | AS plastic

Ø 8 x 23 cm



52531
Cotopaxi

Bottiglia trasparente con tappo a vite dotato di pratico laccetto. | Transparent bottle with colored lid and handle

Plastica | Plastic

Ø 6,6 x 22,5 cm - 600 ml



52166
Lallo

Borraccia con finitura trasparente. Tappo e base in acciaio inox. | Bottle in transparent finishing. Cap and base in stainless steel.

Plastica AS | AS plastic

26,5 x 7,1 cm



52140
Avaro

Borraccia sportiva con tappo con beccuccio a pressione. | Sports bottle with cap with pressure spout.

PE | PE

Ø 7,5 x 20,5 cm



52141
Avena

Borraccia sportiva con tappo nero a vite con beccuccio, corpo disponibile in vari colori. | Sports bottle with black screw cap with dispenser.

Plastica | Plastic

Ø 7,5 x 23,5 cm





.19 .02 .03 .06 .07 .08 .17 .05



52109
Amusa

Borraccia pieghevole con tappo di sicurezza e moschettone. | Drink bottle, foldable, with carabiner belt clip

Plastica | Plastic

12 x 27,3 x 3,2 cm



.08 .04 .06 .05 .02



52059
Fitri

Borraccia a forma di t-shirt, 470ml, pieghevole. Con tappo a vite con cappuccio. Moschettone in metallo colorato | T-shirt bottle of 470ml capacity with flexible PET. With screw-on safety cap with closing hood and matching colour metal carrying carabiner.

PET | PET

25,5 x 17 x 3,3 cm



.02 .23



52193
Livermorio

Bottiglia pieghevole con beccuccio a pressione e tappo. Ideale per eventi sportivi. | Foldable bottle that includes a carrying handle.

TPU | TPUs

8,6 x 2 x 12 cm



.01 .02 .05

.08 .07 .04

.32



52055
Garaguso

Bicchiere con tappo con dosatore di sicurezza e base con inserto in morbida gomma. | Cup with safety dosing cover and soft foam padded base.

Acciaio Inossidabile | Stainless steel

Ø 7,3 x 14,4 cm



.05

.03



52057
Vässad

Tazza doppia parete con coperchio | Mug with double wall. Closing lid.

Plastica, Acciaio inossidabile | Plastic, Stainless steel

Ø 8,6 x 10,7 cm



.02 .01

.05 .08

.32



52505
Cook

Bicchiere con finitura geometrica. Con pratico versatore e base con inserto morbido. | Cup with safety dosing cover and soft foam padded base.

Acciaio Inossidabile | Stainless steel

Ø 7,2 x 16,7 cm



.19 .24

.07

.23



52096
Pårå

Bicchiere con tappo a pressione e fascia in silicone. | Tumbler with press-on lid and silicone grip.

Acciaio Inossidabile, silicone | Stainless steel, silicone

10 x Ø 10 cm



.02



52240
Zugliano

Bicchiere termico doppia parete, finitura lucida, capacità, tappo a vite con chiusura antiperdita con pratica apertura richiudibile, per bere. | Double wall thermal tumbler, glossy finish, capacity, screw cap with anti-leakage closure with practical resealable opening, for drinking.

Plastica | Plastic

NEW



74275
Nogara

Tazza con manici pieghevoli. | Mug with folding handles.

Acciaio Inossidabile | Stainless steel

8,2 x 9,2 cm



NEW



74270
Cison

Contenitore termico doppia parete con tappo a vite | Double walled thermal container with screw cap

Acciaio Inossidabile | Stainless steel

14,7 x Ø 9,5 cm



NEW



52213
Cinto

Bicchiere termico doppia parete. Tappo a vite con anti perdita con pratica apertura richiudibile, per bere | Double walled thermo tumbler Anti-leak screw cap with practical reclosable opening for drinking

Acciaio Inossidabile | Stainless steel

14,6 x Ø 8,9 cm



NEW



52019
Keith

Tazza con manico a moschettone | Mug with carabiner handle.

Acciaio Inossidabile | Stainless steel

Ø 7 x 8,2 cm



74128
Guadalquivir

Tazza con design bicolore, corpo lucido. | Mug with a glossy body, bicolor design.

Acciaio Inossidabile | Stainless steel

8,9 x Ø 7,6 cm



52245
Tambre

Bicchiere termico doppio strato. Tappo a pressione, antiperdita, in plastica con pratico forellino per bere. Fornito in confezione singola. | Double layered thermal tumbler. Pressure cap, anti-leak, in plastic with practical hole for drinking. Supplied in single pack.

Acciaio Inossidabile | Stainless steel

Ø 8,8 x 11,2 cm



NEW





.23

.02



74258
Curry

Bicchieri pieghevole ideale per eventi sportivi. | Folding cup ideal for sporting events.

TPU | TPUs

8,9 x 2,1 x 3,7 cm



.04

.23

.08

.07

.06



.08

.01

.05



74076
Mizar

Bicchieri singola parete con fascia in silicone e coperchio a pressione. | Single-walled tumbler with silicone band and snap lid.

Plastica, Silicone | Plastic, Silicone

11,5 x Ø 9,7 cm



.23

.29

.08



.19

.23

.06

.08

.02



48045
Belmullet

Bicchieri ripiegabile, con coperchio portapillole, dotato di moschettone | Drinking cup, foldable, including compartment for pills, carabiner belt clip

Plastica | Plastic

7,1 x 3,4 cm



Antibacterial

.02



74174
Artemio

Bicchieri pieghevole antibatterico con coperchio e moschettone. | Antibacterial foldable cup with lid and carabiner.

PP antibatterico | Antibacterial PP

Ø 6,8 x 9 cm



74155
Trou

Bicchieri con coperchio apribile | Tumbler with openable lid.

Plastica | Plastic

16,5 x Ø 8,5 cm



74047
Marit

Bicchieri singola parete con coperchio a pressione e fascia in silicone. | Single-wall tumbler with press-on lid and silicone grip.

Ceramica | Ceramic

Ø 10 x 17 cm



YOUR BESPOKE PAPER CUPS

Custom printed paper cups are an excellent opportunity to build your company image.



bespoke
expert in special productions



.21

NATURAL CORK



.13



74276
Pettorazza

Bicchiere riutilizzabile | Reusable cup

PP | PP

11,6 x Ø 9,2 cm



74233
Dossa

Tazza riutilizzabile con capacità di 350 ml. Corpo in PP con rivestimento in sughero naturale. | 350 ml reusable cup. Body in PP and a covering layer of natural cork.

Sughero, PP | Cork, PP

Ø 8,5 x 11 cm



PLA 100% COMPOSTABLE



.02



74241
Omega

Tazza in PLA compostabile al 100%. Finitura solida e senza BPA. | Mug made of 100% compostable PLA. In a solid finishing and BPA free.

PLA 100% Compostabile | PLA 100% Compostabile

Ø 7,9 x 8,8 cm



PLA 100% COMPOSTABLE



.02



74240
Sidney

Bicchiere realizzato in PLA compostabile al 100%. Finitura solida e con tappo dosatore di sicurezza nello stesso materiale, senza BPA. | Cup made of 100% compostable PLA. In a solid finishing and with security lid in self material, BPA free.

PLA 100% Compostabile | PLA 100% Compostabile

Ø 9,3 x 13,4 cm



BOROSILICATE



330 ML

.21



74274
Monfumo



Bicchiere satinato, ideale per la sublimazione. | Frosted glass, ideal for sublimation.
Vetro Borosilicato | Borosilicate glass

9,3 x Ø 7,8 cm



BOROSILICATE



500 ML

.21



74273
Lorenzago



Tazza satinata, ideale per la sublimazione. | Satin mug, ideal for sublimation.
Vetro Borosilicato | Borosilicate glass

15,1 x Ø 8,1 cm



700 ML



.02

SPECIAL FOR SUBLIMATION



74272
Gambellara



Tazza con finitura lucida, ideale per la sublimazione | Mug with a glossy finish, ideal for sublimation

Ceramica | Ceramic

13,8 x Ø 10,4 cm



.32



74261
Taipei

Set di 2 cannuce, una dritta e l'altra curva. Presentato in un sacchetto di cotone | Set of 2 straws, one straight and another curved. Presented in a cotton bag

Acciaio Inossidabile, Cotone | Stainless Steel, Cotton

3,5 x 24,5 cm



.32



74200
Busa

Set di 2 cannuce, spazzolino per la pulizia delle cannuce. Set confezionato in custodia di fibra ecologica | Set of 2 straws, brush for cleaning straws. Set packed in ecological fiber case

Acciaio Inossidabile | Stainless steel

3,5 x 24,5 cm



74220
Golia

Cannuccia riutilizzabile ed estensibile in acciaio inossidabile con punta in silicone | Reusable and extensible straw in stainless steel material with silicone tip

Acciaio Inossidabile, silicone | Stainless steel, silicone

Ø 1,6 x 10,5 cm



.02

.01



BAMBOO LID

DOUBLE WALL



.00

BOROSILICATE



74268
Ceggia



Tazza doppia parete con coperchio in bambù. Fornita in confezione singola. | Double walled mug with bamboo lid. Supplied in a single pack.

Vetro Borosilicato | Borosilicate glass

9,6 x Ø 8,8 cm



.21

BOROSILICATE



74222
Cassibile



Tazza con coperchio a pressione. Cucchiaino integrato nella tazza | Mug with press-on lid. With bamboo spoon integrated.

Vetro Borosilicato, Bamboo | Borosilicate glass, Bamboo

10,6 x Ø 8,7 cm



.00

BOROSILICATE



DOUBLE WALL

BAMBOO LID



74244
Sanseveria



Bicchiere in vetro a doppia parete con coperchio di bambù | Double-walled glass with a bamboo lid.

Borosilicato, Bamboo | Borosilicate, Bamboo

Ø 8,5 x 12,3 cm

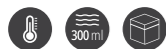

.00

BOROSILICATE



74245
Scevola



Barattolo in vetro a doppia parete con coperchio in bambù | Double-walled glass bottle with bamboo lid.

Borosilicato, Bamboo | Borosilicate, Bamboo

8,6 x 15,5 cm





.02



74224
Chero

Tazza con coperchio a pressione. | Mug with press-on lid.

Ceramica, Bamboo | Ceramic, Bamboo

10,5 x Ø 8,2 cm



NATURAL CORK



.02



74254
Cromo

Tazza con base in sughero che può essere rimossa per il lavaggio. Finitura per la sublimazione. | Ceramic mug with cork base that can be removed for washing process. Special finish for sublimation.

Ceramica, Sughero Naturale | Ceramic, Natural Cork

Ø 9 x 11 cm



NATURAL CORK



.02

.01



74232
Cuto

Tazza con base in sughero | Mug with cork base.

Ceramica, Sughero Naturale | Ceramic, Natural Cork

11 x Ø 9 cm



NATURAL CORK

CERAMIC



TOP SELLER
★★★



A



74160
Laurier

Tazza particolarmente adatta alla sublimazione. | Mug suitable for sublimation.

Ceramica | Ceramic

Ø 7,4 x 8,4 cm



GLOSSY FINISH



.02

B



74177
Barzio

Tazza con finitura opaca e trattamento speciale per la sublimazione. | Mug with a matt finish allowing it to be sublimated.

Ceramica | Ceramic

Ø 8 x 9,5 cm



MATT FINISH



.02

C



74005
Madina

Tazza bianca per sublimazione. | Ceramic mug in white, for sublimation printing.

Ceramica | Ceramic

Ø 8 x 9,5 cm



GLOSSY FINISH



.02

D



74269
Cencenighe

Tazza in ceramica di alta qualità, finitura speciale per sublimazione. | High quality ceramic mug, special sublimation finish.

Ceramica | Ceramic

Ø 8 x 9,5 cm



GLOSSY FINISH



.02



74266
Cavaso

Tazza in ceramica per incisione laser, esterno colorato, interno bianco. Dopo l'incisione il colore del logo sarà bianco come l'interno della tazza. | Laser engraving ceramic mug, colored outside, white inside. After engraving, the color of the logo will be white like the inside of the cup.

Ceramica | Ceramic

9,6 x Ø 8,2 cm

350 ml

74267
Curtarolo

Tazza in ceramica per incisione laser, interno colorato, esterno nero. Dopo l'incisione il colore del logo sarà colorato come l'interno della tazza. | Laser engraving ceramic mug, colored inside, black outside. After engraving, the color of the logo will be colored like the inside of the cup.

Ceramica | Ceramic

9,6 x Ø 8,2 cm

350 ml



74157
Kwania

Tazza con esterno bianco realizzato appositamente per l'incisione laser (compare il colore dell'interno della tazza), interno in vari colori. | Mug with outside part in white, especially designed for laser printing (it appears the color of the inside), and inside in bright tones.

Ceramica | Ceramic

9,6 x Ø 8,2 cm

350 ml

LASER PRINTING

Appositamente progettato per la stampa laser. Appare il colore della parte interna.

Especially designed for laser printing. It appears the color of the inside.



CLASSIC MUG 370ML
Mug in different colors made of ceramic.



74444
Stiu

Tazza colorata | Mug in different colors

Ceramica | Ceramic

Ø 8 x 9,5 cm

370 ml





.01



74028
Erman

Tazza con esterno nero che con il calore dei liquidi cambia colore e fa apparire il logo | Mug with outside in black colour, with hot liquid it changes colour and let the logo appear. Inside in white colour.

Ceramica | Ceramic

12 x 8 x 9,5 cm



.06

.05

.29

.07

.08



.01



74054
Prali

Tazza con interno bianco ed esterno colorato. | Mug with outside in white and inside in varied colours.

Ceramica | Ceramic

12 x 8,2 x 9,5 cm



.19

.08



.01

.08

.23



74056
Bei

Tazza con esterno bianco e interno colorato. | Mug, white colour outside with inside in different colors.

Ceramica | Ceramic

12 x 8 x 9,5 cm



74027
Celil

Tazza mug, colorata con interno bianco | Mug available in different colors with white inside

Ceramica | Ceramic

12 x 8 x 9,5 cm



.23

.01

.07

.08



.19



74169
Barreiras

Tazza con base in silicone colorate, esterno bianco e interno colorato. | Ceramic mug with Silicone base. White exterior and colored interior.

Ceramica | Ceramic

12 x 300 ml



74150
Coronilla

Tazza sospesa con manico di design. | Hanging mug with design handle.

Ceramica | Ceramic

12 x 8,5 cm



74145
Gangi

Tazza con scomparto porta biscotti. | Mug with biscuits holder compartment

Ceramica | Ceramic

10 x 8 x 7,5 cm



RETRO DESIGN METAL MUG

Especially designed for sublimation printing





 74179 **Patiala** 

Tazza in metallo dal design retrò. Appositamente realizzata per la sublimazione, con bordo cromato. | Retro design metal mug. Especially designed for sublimation printing, with an elegant chromed ring.

Metallo | Metal
 ☐ 8,7 x 7,9 cm
 



 74601 **Ossidiana** 

Tazza dallo stile vintage con trattamento speciale per la sublimazione. | Ceramic mug in a vintage design with a special finish for sublimation printing.

Ceramica | Ceramic
 ☐ 8 x 9,5 cm
 





 74154 **Gaggi**

Tazza con esterno colorato, interno bianco con bordo superiore nero. | Mug in combination of outside in a wide range of vintage tones and inside in white colour with black piping.

Metallo | Metal
 ☐ 8 x 8 cm
 



 74190 **Penza** 

Tazza con finitura speciale per la sublimazione, con cucchiaino nel manico. | Mug with special finish for sublimation, with spoon in the handle.

Ceramica | Ceramic
 ☐ 8 x 9,5 cm
 



 74590 **Isojoki**

Tazza stile vintage. Esterno disponibile in diversi colori, interno bianco con bordatura nera. | Mug with vintage design. In combination with outside in a wide range of tones and inside in white with black piping.

Ceramica | Ceramic
 ☐ 8,5 x 8 cm
 



 74151 **Gonnesa** 

Tazza quadrata. Capacità 320 ml | Ceramic squared mug. Capacity 320 ml.

Ceramica | Ceramic
 ☐ 8 x 8 x 8 cm
 



.05 .06



.08



.02



.02



74026
Soa

Tazza bianca con interno colorato. | White cup with colored interior.

Ceramica | Ceramic
Ø 9,5 x 10 cm



74164
Barrafranca

Tazza in ceramica con base in alluminio. | Ceramic mug with aluminium base.

Ceramica | Ceramic
350 ml



74198
Soaf

Tazza in ceramica | Ceramic mug

Ceramica | Ceramic
Ø 8,5 x 10 cm



.23 .07 .19 .06 .18



.08



74006
Arama

Tazza con esterno bianco e interno colorato. Con cucchiaino inserito nel manico. | Ceramic mug, outside white, inside coloured. With built-in ceramic spoon in handle.

Ceramica | Ceramic
Ø 8 x 10 cm



.29 .01 .07



.06 .01 .29 .07 .18



.08



.08



74019
Elma

Tazza in ceramica. | Ceramic mug.

Ceramica | Ceramic
Ø 9 x 10 cm



74256
Cumino

Tazza con finitura smaltata colorata. | Ceramic mug with colored enamel, 300 ml.

Ceramica | Ceramic
Ø 8,2 cm



.05 .03 .19



.08

RUBBER
FINISH



74152
Chysis

Tazza con finitura gommata. | Ceramic mug with rubber finish

Ceramica | Ceramic
9,5 x Ø 9,5 cm





240 ML

.02

74163
Barraba

Set 2 tazze da cappuccino. | Set of ceramic cappuccino cups.

Ceramica | Ceramic

240 ml



CERAMIC



.05

74085
Epsilon

Infusore con corpo semitrasparente. | Infuser in translucent colour.

Plastica | Plastic

15 x Ø 3,1 cm



90 ML

.02

74168
Barrea

Tazzina da caffè espresso con piattino. | Espresso cup with saucer.

Ceramica | Ceramic

Ø 5,5 x 6,3 cm



.23 .07 .08 .19



80 ML

.02

74167
Barranquilla

Tazzina da caffè espresso con piattino. | Ceramic espresso cup with saucer.

Ceramica | Ceramic

80 ml



.21

74235
Ega

Tazzina per caffè | Coffee cup

Vetro | Glass

Ø 6 x 5 cm



.21

74203
Birra

Tazza in vetro speciale per sublimazione. | Glass mug. Perfect for sublimation.

Vetro Borosilicato | Borosilicate glass

9,5 x Ø 8 cm

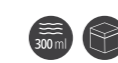

BOROSILICATE





SET OF 2 CUPS

Set consisting of 2 double-walled borosilicate glass glasses



80 ML

BOROSILICATE



74277
Pozzonovo



Servizio da caffè composto da due tazzine in vetro e due sottobicchieri. | Coffee set consisting of two glass cups and two coasters.

Vetro Borosilicato, Bamboo | Borosilicate glass, Bamboo

9 x 9 x 1 cm



75 ML



DOUBLE WALL

BOROSILICATE



74265
Cavarzere



Set composto da 2 bicchieri doppia parete in vetro borosilicato. | Set consisting of 2 double-walled borosilicate glass glasses.

Vetro Borosilicato | Borosilicate glass

6,6 x Ø 6,7 cm

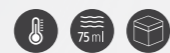

110 ML

BOROSILICATE



74209
Salice



Tazza di vetro, 6 cm di diametro e 8 cm di base. | Glass mug of 6 cm diameter, with 8 cm base.

Vetro, Bamboo | Glass, Bamboo

Mug: Ø 6 x 5,7 cm / Coaster: Ø 8 cm





Rain

and

Umbrellas

Rain and Umbrellas

Gamma di ombrelli: manuali, automatici, pieghevoli, anti vento, con luce di sicurezza, classici, fluorescenti e dal design innovativo. Impermeabili per adulti, impermeabili per bambini e poncho.

Line of umbrellas: manual, automatic, folding, windproof, with safety light, classic, fluorescent and innovatively designed. Adult raincoats, children's raincoats and ponchos.

AUTOMATIC UMBRELLA

Self-opening and closing umbrella with matching pouch.

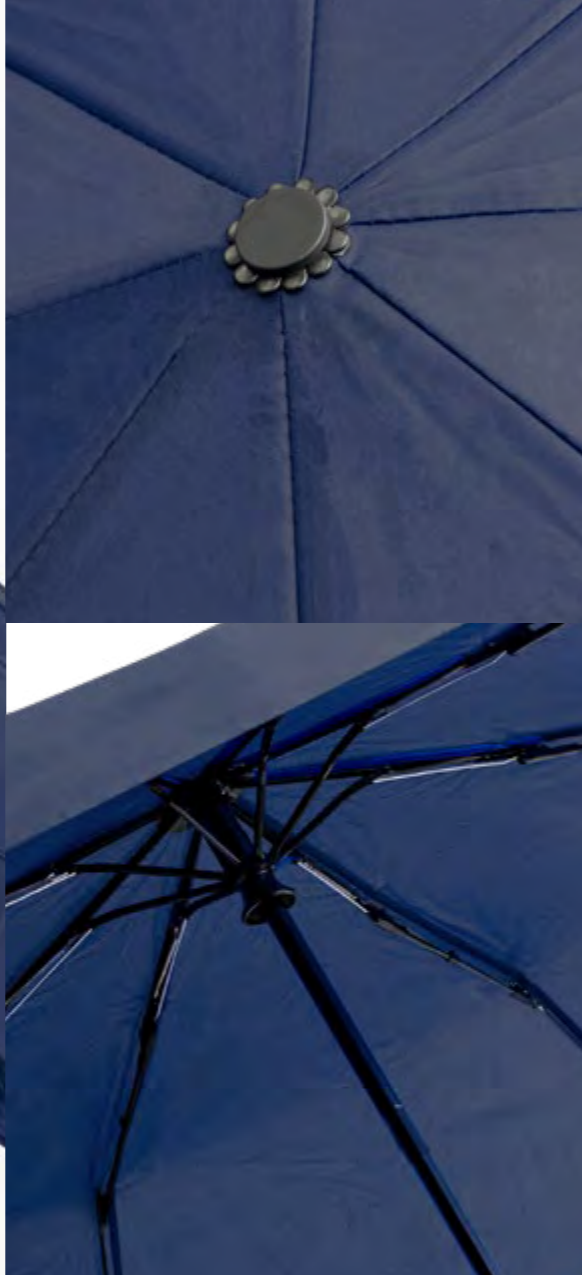

100 cm

SPECIAL FOR SUBLIMATION



.02 .05 .01 .08



90038
Brenzone

NEW

Ombrello con apertura e chiusura automatica, con pouch coordinata. Asta nera in metallo, stecche in fibra di vetro, colore nero, con manico in bambù naturale. Chiusura in velcro colorata e coordinata | Self-opening and closing umbrella with matching pouch. Black metal rod, fiberglass ribs and natural bamboo handle. Matching velcro fastener

Poliestere Pongee 190T | Polyester Pongee 190T

100 x 57 cm

8 PAN



.01 .23 .08 .02



100 g St

RECYCLED PLASTIC



90034
Joe

Ombrello pieghevole. Apertura manuale, antivento con stecche in metallo. Manico in legno con laccetto e pouch | 3 section foldable umbrella in 190T pongee RPET material. Manual opening, with windproof mechanism and metal ribs. Wooden handle, with carrying strap and pouch in matching colours.

Pongee 190T RPET | Pongee 190T RPET

95 cm

8 PAN



.19



100 g St

RECYCLED PLASTIC



.01



90036
Pagoda

Ombrello pieghevole con apertura manuale. Aste in metallo, manico in legno e custodia per il trasporto. | Manual opening folding umbrella. With metal rods, wooden handle and carrying cover.

Pongee RPET | Pongee RPET

95 x 58 cm

8 PAN



MANUAL UMBRELLAS

In recycled plastic





REVERSIBLE UMBRELLA



91034
giustino

Ombrello reversibile, apertura manuale, stecche in fibra di vetro, chiusura in velcro. | 8-panel reversible umbrella, made of resistant, 108cm in diameter, with manual opening, fiber ribs and velcro closure.

Pongee | Pongee
Ø 107 x 80 cm



90032
Playfulnes

Ombrello pieghevole con apertura manuale. Con asta e stecche in metallo. Fornito con pouch. | 3 section foldable umbrella with manual opening. With metal shaft and metal ribs. Supplied with pouch

Poliestere 190T, Alluminio | 190T Polyester, Aluminium
Ø 95 cm



90027
Corazon

Ombrello con apertura e chiusura automatica. Asta in metallo e stecche in fibra di vetro. Fornito con pouch coordinata. | Umbrella with automatic opening and closing, with steel body and fiberglass ribs. Supplied with matching pouch.

Pongee | Pongee
56 x Ø 95 cm



CARABINER HANDLE

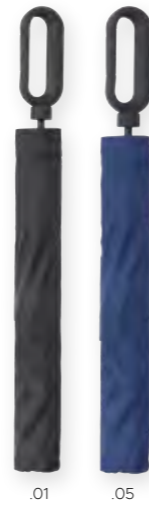

90056
Ranarp

Ombrello golf pieghevole con apertura automatica. Asta in fibra di vetro e stecche in metallo. Con manico a moschettone. Fornito con pouch. | 2 section foldable golf umbrella with automatic opening. Fiberglass shaft and metal ribs. With carabiner handle. Supplied with pouch.

Poliestere 190T, Fibra Di Vetro | 190T Polyester, Fiberglass
Ø 120 cm



91019
Nyon

Ombrello pieghevole con apertura automatica. Asta e stecche in metallo. Manico in plastica con laccetto. Fornito con pouch. | 3 section foldable umbrella with automatic opening. Metal shaft and ribs. Plastic handle with carrying strap. Supplied with pouch.

Poliestere 190T | 190T polyester
Ø 98 cm/Ø 4,5 x 24,5 cm





Ø 96 cm



90025
Acuto

Ombrello pieghevole 3 sezioni, apertura manuale, con stecche in metallo color argento, chiusura con velcro e impugnatura ergonomica. Fornito con pouch. | Folding umbrella. Manual opening, with silver colored metal ribs, velcro closure and ergonomically shaped carrying strap. Presented in a matching color individual case.

Poliestere 170T | 170T polyester

Ø 96 cm

8 PAN



Ø 98 cm



.04 .08



90009
Rig

Ombrello pieghevole con apertura manuale. Con stecche in metallo nere, chiusura in velcro e laccetto. Fornito con pouch | 8-panel folding umbrella. 98cm in diameter, with manual opening. Presented in a matching colour individual case.

Poliestere 170T | 170T polyester

Ø 98 cm

8 PAN



Ø 98 cm



.08 .02 .01 .05



90037
Paulette

Ombrello pieghevole con apertura manuale, 3 sezioni, struttura nera in metallo, fornito con pouch in tinta, cordino in tinta | Folding umbrella with manual opening, 3 sections, black metal frame, supplied with matching pouch, matching lanyard

Poliestere 190T | 190T polyester

Ø 98 cm

8 PAN

FOLDABLE UMBRELLA

With automatic opening. 190T pongee fabric with matching pouch



90040
Taibon

Ombrello richiudibile con apertura automatica. Pouch coordinata. Manico in EVA e stecche in metallo nero. | Foldable umbrella with automatic opening. Matching pouch. EVA handle and black metal ribs.

Pongee 190T | Pongee 190T

Ø 98 cm

8 PAN

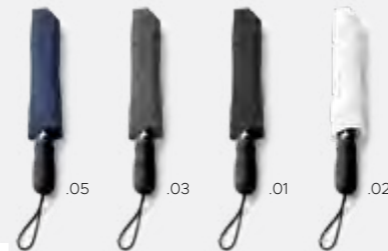

.05 .03 .01 .02

NEW



Ø 98 cm



91046
Brendola

NEW

Ombrello con manico finitura morbida nera e apertura automatica. Asta in fibra di vetro con sistema anti vento. Puntale in plastica nera. | Umbrella with soft black finish handle and automatic opening. Fiberglass rod with windproof system. Black plastic toe cap.

Poliestere Pongee 190T | Polyester Pongee 190T

Ø 107 x 82 cm

8 PAN



91044
Brentino

NEW

Ombrello apertura automatica, antivento, realizzato in tessuto pongee, asta e stecche in fibra di vetro e manico in EVA. | Windproof automatic opening umbrella made of pongee fabric, fiberglass rod and ribs and EVA handle.

Asta e stecche: fibra di vetro; Manico: EVA; Tessuto pongee | Shaft and Ribs: Fiberglass; Handle: EVA; Pongee fabric

Ø 134 x 102 cm

8 PAN



91507
Nocciola

Ombrello, apertura automatica, manico in EVA con dettaglio nero. | 8 panel umbrelli. 105cm in diameter, with automatic opening and in resistant polyester material, EVA handle in matching colour accessories in black colour.

Poliestere | Polyester

Ø 105 cm

8 PAN



91035
pokal

Ombrello con apertura automatica con asta e stecche in metallo. Manico in EVA. Fornito con pouch. | Automatic opening umbrella with metal shaft and ribs. Eva handle. Supplied with pouch.

Poliestere 190T, Alluminio | 190T Polyester, Aluminium

Ø 105 cm

8 PAN



91506
Petra

Ombrello con apertura manuale. Con stecche metalliche color argento, chiusura con velcro. | Umbrella with manual opening. With metallic ribs in silver color, velcro closure.

Poliestere 170T | 170T polyester

Ø 105 cm

8 PAN



Ø 105 cm

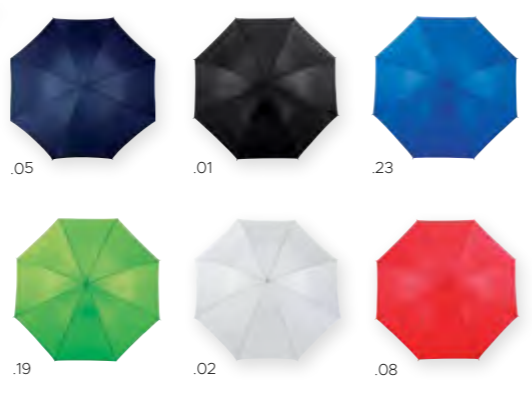

.24



91502
Omar

Ombrello con manico, asta e finitura in legno. Stecche nere. Chiusura in velcro. Apertura manuale. | Umbrella with handle, shaft and tips in wood. Ribs in black. Manual opening.

Poliestere 190T | 190T polyester

Ø 105 cm

8 PAN



.40



.01 .05

Ø 105 cm

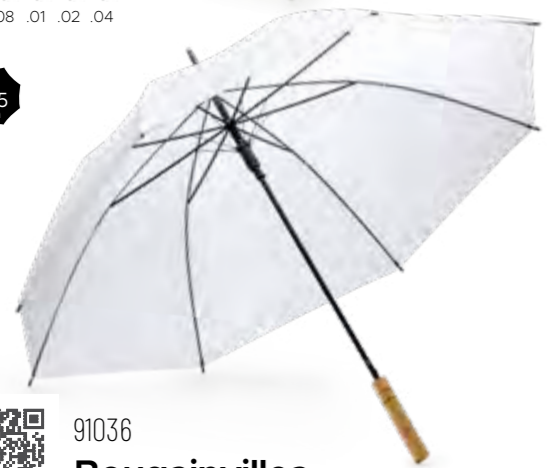

91036
Bougainvillea

Ombrello con manico in legno, apertura automatica. Stecche e puntine in colore nero. Chiusura in velcro. | Umbrella with wooden handle and automatic opening. Ribs and tips in black. Velcro fastening.

Poliestere 190T | 190T polyester

Ø 105 cm

8 PAN



.05



90012
Quirina

Ombrello pieghevole con apertura automatica, manico curvo in legno, asta e stecche in metallo. Fornito con pouch | Automatic opening 2 section foldable umbrella with wooden handle. With metal shaft and metal ribs. Presented with individual nylon pouch.

Nylon 170T | 170T nylon

Ø 106 cm

8 PAN



UMBRELLA WITH WOODEN HANDLE

Classic nylon umbrella with wooden shaft and crook wooden handle.



.05 .10 .04 .19 .01 .02

Ø 100 cm



91503
Vidal

Ombrello classico con apertura automatica, manico in legno, chiusura con velcro | Umbrella with wooden shaft and crook wooden handle. Velcro fastening

Poliestere 190T | 190T polyester

Ø 100 x 89 cm

8 PAN



WOODEN HANDLE

.08

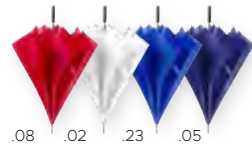

Ø 130 cm



92031
Basiano

Ombrello misura XL, antivento. Apertura automatica, con stecche in fibra di vetro nera. Manico in Eva, chiusura in velcro. | Umbrella in XL size with windproof mechanism-. Automatic opening, fiber ribs. With padded EVA handle and velcro closure.

Poliestere 190T | 190T polyester

Ø 130 cm

8 PAN



Ø 122 cm



91512
Clown

Ombrello con apertura automatica, con struttura in acciaio inox, barre in fibra di vetro e manico in EVA. | Umbrella with automatic opening with structure of stainless steel, bars of fiberglass and handle of EVA.

Pongee 190T, Acciaio Inox, Fibra Di Vetro | 190T Pongee, Stainless Steel, Fiberglass

Ø 122 x 95 cm

8 PAN

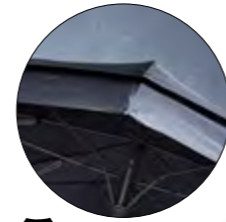

Ø 128 cm



92026
Silviams

Ombrello espandibile da 23" a 30" con apertura automatica. Asta e stecche in fibra di vetro. Manico gommato. | 23" to 30" expanding umbrella with automatic opening. Fiberglass shaft and ribs. Rubberized handle.

Poliestere 190T Pongee | Polyester 190T Pongee

Ø 128 x 82,5 cm

8 PAN

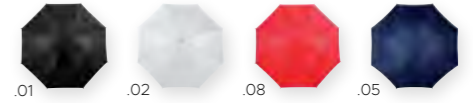

Ø 130 cm



92008
Rosa

Ombrello con apertura manuale con asta e stecche in metallo. Manico in legno. | Golf umbrella XL with metal shaft and wooden handle

Poliestere 170T | 170T polyester

Ø 130 x 105 cm

8 PAN

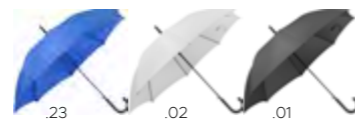

Ø 105 cm



91038
Iota

Ombrello con apertura automatica, 8 pannelli, struttura in fibra di vetro. | Umbrella with automatic opening, 8 panels, fiberglass frame.

Pongee, Fibra di vetro | Pongee, Fiberglass

Ø 105 x 83 cm

8 PAN



91022
Mice

Ombrello automatico. 8 pannelli. Struttura in fibra di vetro. Ampia area di stampa. | Automatic umbrella. 8 panels. Fiberglass structure.

Poliestere 190T | 190T polyester

Ø 100 cm

8 PAN



Ø 105 cm



91055
Rimforsa

Ombrello apertura automatica con asta e stecche in fibra di vetro nera. Manico curvo. | Automatic opening umbrella with black glass fiber shaft and ribs. With curved handle.

Poliestere Pongee 190T, Fibra Di Vetro | Polyester Pongee 190T, Fiberglass

Ø 105 cm

8 PAN



Ø 105 cm



91037
Poppig

Ombrello con apertura automatica con asta e stecche in fibra di vetro colorata. Manico in EVA. | Automatic opening umbrella with coloured fiberglass shaft and ribs. EVA handle.

Poliestere 190T, Fibra Di Vetro | 190T Polyester, Fiberglass

Ø 105 cm

8 PAN



YOUR BESPOKE UMBRELLA



Seleziona il tuo stile preferito ①
Select your favorite style

Seleziona la dimensione ②
Select the size

Seleziona il tipo di stampa che ti serve ③
Select the kind of printing you need

Il tuo ombrello è pronto! ④
Your umbrella is ready!



Ø 100cm
Ø 125cm



UMBRELLA-1

Ombrello con stampa in quadricromia, 8 pannelli, apertura automatica, con asta e stecche in fibra di vetro | Umbrella with four-color printing, 8 panels, automatic opening, with fiberglass shaft and ribs

Pongee 210T | Pongee 210T

☐☐☐ ☐ 125 x 89 cm



Ø 100cm
Ø 125cm



UMBRELLA-2

Ombrello con stampa in quadricromia, 8 pannelli, apertura automatica, con asta e stecche in fibra di vetro | Umbrella with four-color printing, 8 panels, automatic opening, with fiberglass shaft and ribs

Pongee 210T | Pongee 210T

☐☐☐ ☐ 125 x 89 cm



Ø 100cm
Ø 125cm



UMBRELLA-3

Ombrello con stampa in quadricromia, 8 pannelli, apertura automatica, con asta e stecche in fibra di vetro | Umbrella with four-color printing, 8 panels, automatic opening, with fiberglass shaft and ribs

Pongee 210T | Pongee 210T

☐☐☐ ☐ 100 cm



Ø 135 cm



Ø 115 cm



PONGEE 190T

PONGEE 190T

FIBERGLASS SHAFT AND RIBS

FIBERGLASS SHAFT AND RIBS



92067
Regissör

Ombrello Maxi golf automatico con asta e stecche in fibra di vetro. Manico di gomma con pulsante argentato. | Maxi golf automatic opening umbrella with fiberglass shaft and ribs. Rubber handle with silver button.

Pongee 190T, Fibra Di Vetro | Pongee 190T, Fiberglass

☐☐☐ ☐ 135 cm



91058
Samla

Ombrello apertura automatica con asta e stecche in fibra di vetro nera. Fornito con pouch. | Automatic opening umbrella with black fiberglass shaft and ribs. Supplied with pouch.

Pongee 190T, Fibra Di Vetro | Pongee 190T, Fiberglass

☐☐☐ ☐ 115 cm





.02

.38



.55



R5201
Sitka

Giacca da pioggia impermeabile. | Waterproof raincoat.
Poliestere RPET, Similpelle - 180 gr/m2 | Polyester RPET, Leatherette - 180 gr/m2
S, M, L, XL, XXL



.02

.38



.55



R5202
Sitka woman

Giacca da pioggia impermeabile. | Waterproof raincoat.
Poliestere RPET, Similpelle - 180 gr/m2 | Polyester RPET, Leatherette - 180 gr/m2
S, M, L, XL, XXL



**WATERPROOF
JACKET WITH
HOOD**

Waterproof raincoat.



.04



93043
Robonic

Giacca impermeabile trapuntata con cappuccio e polsino con elastico. | Water-
proof quilted jacket with hood and elastic cuffs

Pvc | pvc

M/XL



.33



.04



93038
Giovo

Giacca impermeabile con cappuccio e polsino con elastico. | Waterproof jacket
with hood and elastic cuffs

Pvc | pvc

XL





93002
Tabo

Poncho adulto con portachiavi. Fornito in custodia a forma di pallina con chiusura di sicurezza. | Adult poncho keychain. Presented in an individual ball case with safety lock.

Lpde | Lpde

Close Ø 6,4 cm Size adulto/Adult Size/ Tamaño Adul



.21

PLA 100% COMPOSTABLE



.04



.21 .06



.23 .08



93069
Adams

Impermeabile in 100% PLA compostabile. Taglia unica adulto. 127x102cm. | Raincoat made of 100% PLA compostable. One size adult. 127x102cm

PLA 100% Compostabile | PLA 100% Compostabile

127 x 140 cm, close 10 x 13,5 cm



93001
Turi

Poncho con finiture termosaldate. Fornito in bustina. | Poncho with heat-sealed finish. Presented in an individual transparent bag.

Hdpe | Hdpe

127 x 140 cm, close 9 x 12,5 cm



.02 .06
.05 .08



93049
Torio

Impermeabile con finiture termosaldate, chiusura centrale con 4 bottoni a pressione, tasche laterali con patella, polsini con bottone, 3 spacchetti posteriori e cappuccio regolabile con coulisse. Taglia unica adulto. Custodia inclusa. | Raincoat with heat-sealed trim, central closure with 4 snap buttons, flap side pockets, button cuffs

Materiale impermeabile | Waterproof material

86 x 72 cm

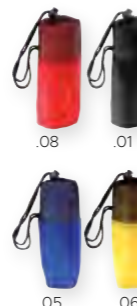

.08 .01
.05 .06



93005
Dattero

Poncho con finiture termosaldate. Chiusure laterali con bottoni, fornito in bustina singola con parte superiore in retina | Poncho in heat-sealed finish. With side closures of bracket and presented in an individual bag with upper part in netting and string with adjustment accessory.

Peva | Peva

19 x Ø 6 cm



.23 .06

.08



93004
Tajo

Poncho con chiusura con bottoni sui lati, finiture termosaldate. Fornito in bustina colorata | Poncho. With button closure on the sides and heat-sealed finish. Presented in a matching colour individual bag with string closure.

Pvc | pvc

22,5 x 18 cm

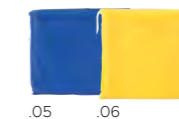

.05 .06



.08



93037
Cosmea

Poncho con chiusura con bottoni sui lati, finiture termosaldate. | Poncho with closing brackets on the sides and heat-sealed finish.

Pvc | pvc

90 x 64 cm



**Personal
and Care**

Set manicure, set da bagno per bambini e set di pennelli per il trucco. Specchietti tascabili, spazzole per capelli, scaldamani, spazzolini da denti, borse da viaggio e cravatte. Supporto per smartphone , porta carte di credito, portachiavi e molto altro...

Manicure set, baby bath set and makeup brush set. Pocket mirrors, hair brushes, hand warmers, toothbrushes, travel bags and ties. Smartphone holder , credit card holder, keychain and more...

Personal and Care





.07 .04 .17 .02 .06 .23



.08



43190
Jaqueline

Beauty case con chiusura ermetica in PVC traslucido. | Beauty bag in translucent PVC with hermetic closure.

Pvc traslucido | Translucent pvc

17 x 12,5 x 4,5 cm



.21 .01



.08



43110
Shadu

Pochette in PVC trasparente, con chiusura zip colorata. | Bag made of transparent PVC, with coloured zipper closure.

Pvc | pvc

18 x 4 x 18 cm



.31

.16

.32



43255
Ormelle

Astuccio dal design lucido, con cerniera e tirazip coordinati. | Pencil case with a glossy design, with matching zip and zip puller.

Similpelle | Leatherette

12 x 8,5 cm

NEW



43250
Bassano

Pochette dal design piatto, in similpelle color oro | Gold Imitation leather flat design clutch bag

Similpelle | Leatherette

23 x 18 cm

NEW

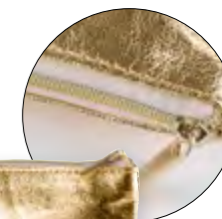

.31



.17 .06



.21



.21



.21



43143
Benagil

Pochette in PVC trasparente con chiusura zip. | Translucent pvc Toiletry bag with zip fastener.

Pvc | pvc

19 x 4,5 x 14 cm



43162
Lawers

Pochette in Eva trasparente con chiusura zip con finitura metallizzata. Senza PVC. | Toiletry bag made of transparent Eva material with zipper closure with metallic finish.

Eva | Eve

19 x 5 x 16 cm



43124
Genga

Pochette con chiusura zip. Senza PVC. | Eva Toiletry bag with zip fastener. Pvc free.

Eva | Eve

18,5 x 4,7 x 14 cm



.31

.32



43203
Trigo

Pochette con finitura metallizzata opaca, chiusura con zip colorata coordinata e tirazip nello stesso materiale. | Toiletry bag made of PU, in a matt metallic finishing, matching colour zipper closure and matching puller.

Similpelle | Leatherette

21 x 15 cm



.01

.31

.16



43135
Gessate

Pochette unisex con chiusura con zip e tirazip con fascetta in PU per una migliore presa. | Unisex toiletry bag with zipper closure with strap zipper puller for easy opening.

Pvc | pvc

18,5 x 11,5 x 2,5 cm



.13



43169
Macchia



Beauty bag in cotone, con ogni lato di un diverso colore. Con patella. Tirazip in corda. | Toilet bag made of cotton, with each face in a different colour and flap, rope puller.

Cotone | Cotton

Aperto: 19,5 x 21 cm

180 gr/m² 280 gr/m²
1st side 2nd side

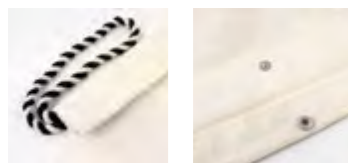

.05 .13 .04



.13



43229
Cardamomo



Pochette con lungo manico in cotone intrecciato. | Cotton toilet bag with a long braided cotton handle.

Cotone - 140 gr/m² | Cotton - 140 gr/m²

Aperto: 26 x 26 x 5 cm / Chiuso: 26 x 18 x 5 cm

140 gr/m²



.08



43231
Foshan

Pochette color natural con chiusura zip colorata. Laccettino in simpelle colorata coordinata, per un più facile trasporto. | Toiletry bag natural colored with colored zip closure. Matching colored leatherette strap for easier transport.

Cotone - 300gr/m² | Cotton - 300gr/m²

21 x 15,5 x 3 cm

300 gr/m²



.01



43206
Segugio

Pochette con tirazip coordinato in tessuto. | Toiletry bag made of black cotton with matching puller with strap for.

Cotone - 280 gr/m² | Cotton - 280 gr/m²

21 x 15 cm

280 gr/m²



.13



43251
Barbarano



Pochette in morbido poliestere particolarmente adatto alla sublimazione. Tirazip coordinato. | Clutch bag in soft polyester particularly suitable for sublimation. Co-ordinated zip puller.

Poliestere | Polyester

22 x 14 x 6,5 cm



SPECIAL FOR SUBLIMATION



.32

SPECIAL FOR SUBLIMATION



43935
Loreo



Pochette. Aspetto cotone, idoneo per la stampa sublimatica | Beauty case. Perfect for sublimation printing.

Poliestere | Polyester

21 x 14 cm



.13

SPECIAL FOR SUBLIMATION



43843
Uscio



Pochette con chiusura zip. Particolarmente adatta alla sublimazione. | Toiletry bag with zipper closure. Especially designed for sublimation printing.

Poliestere | Polyester

20 x 15 cm

450 gr/m²



43240
Bartolomea

NEW

Pochette molto capiente con una finitura vellutata e cuciture fini decorative | Large clutch bag with a velvety finish and decorative fine stitching

Esterno: Cotone, interno: Poliestere | Outer: Cotton, Inner: Polyester

18 x 9 x 6,5 cm

325 gr/m²



43239
Bardolino

NEW

Pochette dal design piatto con una finitura vellutata e cuciture fini decorative. | Flat design clutch bag with a velvety finish and decorative fine stitching.

Esterno: Cotone, interno: Poliestere | Outer: Cotton, Inner: Polyester

24 x 15 cm

325 gr/m²

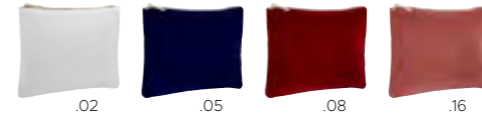

43205
Tarso

Pochette con fodera interna, chiusura con zip e tirazip in color oro. | Toiletry bag made of velvet with inner lining, zipper closure and metal puller in golden colour.

Velluto | Velvet

22,5 x 17,5 cm



43207
Rachele

Pochette a forma di sacca, con chiusura con coulisse e finitura in satin. | Toiletry bag made of velvet in a small bag shape with a string closing and satin finishing.

Velluto | Velvet

Ø 13 x 25 cm



SMOOTH VELVETY FINISH



43249
Follina

NEW

Pochette in cotone con una finitura liscia vellutata. | Cotton clutch bag with a smooth velvety finish.

Cotone | Cotton

21 x 14 x 6 cm

325 gr/m²



.13



43241
Bagnolo

NEW

Pochette realizzata in cotone e poliestere, con finitura morbida effetto spugna. | Clutch bag made of cotton and polyester, with a soft terry effect finish.

Esterno: 60% cotone, 40% poliestere, Interno: cotone | Outer: 60% Cotton, 40% Polyester, Inner: Cotton

24 x 18 x 5 cm

375 gr/m²



.16

.01

.18



43927
Viggiano

Pochette con chiusura zip. Tirazip con pompom con frange | Beauty case with zipper

Cotone | Cotton

20,5 x 14,5 cm

340 gr/m²



.02



43260
Tarzo

NEW

Pochette con tirazip con dettaglio dorato. | Clutch bag with zip puller with golden detail.

Cotone waffle - 240 gr/m² | Waffle cotton - 240 gr/m²

20 x 8 x 14 cm



CURLY TEXTURED FINISH



.13



43238
Baone

NEW

Pochette realizzata in cotone e poliestere con finitura morbida effetto spugna. | Clutch bag made of cotton and polyester with a soft terry effect finish.

Esterno: 60% cotone, 40% poliestere, Interno: cotone | Outer: 60% Cotton, 40% Polyester, Inner: Cotton

20 x 14 x 4,5 cm

375 gr/m²



.02



43259
Scorzè

NEW

Pochette con tirazip con dettaglio dorato. | Clutch bag with zip puller with golden detail.

Cotone waffle - 240 gr/m² | Waffle cotton - 240 gr/m²

21 x 15 cm



.13



43242
Estense

NEW

Pochette con dettagli dorati nella trama del tessuto. Tira zip coordinato | Clutch bag with golden details in the fabric texture. Matching zip puller

85% Cotone, 15% Lurex | 85% Cotton, 15% Lurex

22 x 14,5 x 6 cm

200 gr/m²



.31

.01



43224
Antimonio

Pochette con finiture in lurex che donano particolare brillantezza. Tirazip in tessuto con frange | Clutch bag with lurex finishes that give particular brilliance.

Juta | Jute

21 x 15 cm



.18

.23

.13



.08



43147
sinnlig

Pochette con cerniera colorata | Toiletry bag with coloured zip

Cotone - 220 gr/m² | Cotton - 220 gr/m²

23 x 15,5 x 6 cm

220 gr/m²



.07

.19

.08



.23



43990
Belogorka

Pochette con chiusura zip. Con nastro colorato in poliestere. | Kraft paper pouch with zipper closure. Colourful polyester handle

Carta kraft | Kraft paper

23 x 14 x 7 cm



.23

.08

.19



.07



43160
Anterselva

Pochette. Chiusura con zip e profili colorati a contrasto. | Purse. Zip closure and coloured edging

Cotone | Cotton

21,5 x 13 cm

220 gr/m²



.32

.31



43202
Wally

Pochette, con inserto con finitura metallizzata sui bordi e sul tirazip. | Toiletry bag made of canvas cotton with metallic borders and matching puller.

Cotone - 230 gr/m² | Cotton - 230 gr/m²

20,5 x 13 cm

230 gr/m²



.13

.01

.23

.04



.08



43194
Koku

Beauty case bicolore multiscopo con cerniera con tirazip in tinta. | Multipurpose bag with bicolour finish. Zipper with matching zipper puller.

Cotone | Cotton

22,5 x 5,5 x 17 cm

280 gr/m²



.05

.06

.04

.07

.23



.08



43917
Utrusta

Pochette con chiusura zip coordinata, con tirazip cromato. | Beauty bag bicolour design, matching colour zipper, with chromed puller.

100% Cotone - 220gr/m² | 100% Cotton - 220gr/m²

23 x 8 x 18 cm

220 gr/m²



 43184
Bongo

Pochette in juta laminata e cotone naturale. Con chiusura a cerniera e tirazip in juta abbinato. | Beauty bag in combination of laminated jute and natural cotton. With zip closure and jute puller

Juta Laminato, cotone | Laminated jute, cotton

 20 x 15 x 6 cm



 43226
Californio

Pochette con chiusura zip con cerniera in juta abbinata. | Beauty bag in cotton and laminated jute.

Cotone, juta laminata | Cotton, laminated jute

 21 x 11 x 6 cm



 43233
Shenyang

Pochette unisex. Ampio scomparto principale con chiusura zip. Pratico laccettino in similpelle, per un più facile trasporto. | Unisex toiletry bag. Large main compartment with zip closure. Practical leatherette strap for easier transport.

Juta laminata, cotone canvas | Laminated jute, canvas cotton

 21 x 11 x 6 cm



 43232
Chengdu

Pochette con chiusura zip colorata coordinata. Tirazip con laccetto lungo con frange decorative. | Toiletry bag with coordinated colored zip closure. Zipper puller with long lanyard with decorative fringes.

Juta laminata | Laminated jute

 27 x 16,5 x 7,5 cm



 43187
Boris

Beauty case in cotone ecologico e juta. Fondo e manico in juta. Cerniera dello stesso colore della borsa. | Toilet bag made of 180 gsm cotton and jute. Lower part and puller in jute.

Cotone, Juta | Cotton, jute

 21,5 x 16 x 5 cm

180 gr/m²



 43186
Bonnie

Beauty case in juta con zip in tinta e tirazip in juta. | Toilet bag made of jute, with matching zip and jute puller.

Juta Laminato | Laminated jute

 22 x 14 x 6,5 cm



 43991
Bellosguardo

Pochette con chiusura con coulisse con inserti in legno. | Toiletry bag made cotton with natural colour finishing with strings closing with wood details.

Cotone - 230 gr/m² | Cotton - 230 gr/m²

 Ø 15 x 25 cm

230 gr/m²

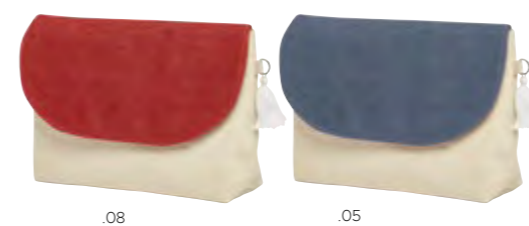

 43166
Astura

Pochette. Chiusura con bottone magnetico. | Purse. Magnetic closure and lateral cotton fringe

Juta, Cotone | Jute, Cotton

 28 x 17 cm





43227
Cappero



Pochette con parte bassa in juta e tirazip in cordino di cotone. | Bag with jute bottom

Cotone Fairtrade - 220gr/m2, Jute - 350 gr/m2 | Fairtrade Cotton - 220gr/m2, Jute - 350gr/m2

20 x 28 cm

220 gr/m²



43214
Rosa



Beauty in cotone equo e solidale | Toilet bag made with fair trade and cotton

Cotone Fairtrade - 280gr | Fairtrade cotton - 280gr

16 x 21 x 5,5 cm

280 gr/m²



43213
Pomodoro



Beauty fabbricato in Europa realizzato in cotone Fairtrade. Tirazip coordinato. | Toilet Bag made in made of Fairtrade cotton. Matching zipper puller.

Cotone Fairtrade - 320 gr/m2 | Fairtrade cotton - 320 gr/m2

21 x 16 cm

320 gr/m²



43211
Piombaggine



Beauty fabbricato in Europa può essere fatto con 3 tipi di cotone: OEKO TEX, riciclato o Fairtrade. | Toilet Bag made in Europe can be made from 3 types of cotton: OEKO TEX, recycled or Fairtrade

Cotone OEKO-TEX - 280 gr/m2 | OEKO-TEX cotton - 280 gr/m2

21 x 16 cm

280 gr/m²

FAIR TRADE TOILETRY BAGS

With matching zipper closure.





100% HEMP FABRIC



43262
Roveredo



Trousse in cotone Fairtrade 100% da 180gr/m2. | Toiletry bag in 100% Fairtrade cotton (180 gsm)

100% Cotone Fairtrade - 180 g/m2 | 100% Fairtrade Cotton - 180 gr/m2

21 x 13 x 8 cm

180 gr/m²



43841
Mianwali



Pochette con chiusura zip coordinata e tirazip in cotone. | Canvas cotton Toiletry bag of organic in natural colour, with matching zipper closure and zipper puller with strap.

Cotone - 280 gr/m2 | Cotton - 280 gr/m2

21 x 16 cm

280 gr/m²



43228
Carbonio



Pochette con cerniera nera a contrasto e tirazip con pendente con frange | Clutch bag with contrasting black zipper and fringed pendant puller

Canapa | Hemp

26 x 22 cm

200 gr/m²



43254
Villaverla



Pochette con scomparto principale con cerniera e tirazip coordinato. | Clutch bag with zipped main compartment and matching zip puller.

Cotone Fairtrade - 180 g/m2 | Fairtrade Cotton - 180 gr/m2

23 x 17 cm

180 gr/m²



43247
Belfiore



Pochette realizzata in 100% cotone Fairtrade | Clutch bag made of 100% Fairtrade cotton

Cotone Fairtrade | Fairtrade cotton

16 x 21 x 5,5 cm

280 gr/m²



43253
Martino



Pochette con scomparto principale con cerniera, tasca frontale con cerniera, tirazip coordinati. | Clutch bag with zipped main compartment, front zipped pocket, matching zip pullers.

Canapa - 200 gr/m2 | Hemp - 200 gr/m2

21 x 13 cm



100% HEMP FABRIC





.23 .04 .08 .01



.09



.08 .19 .05



.13 .04 .01 .05 .08



.13



CHOOSE YOUR PANTONE COLOR



43197
Bletilla



Beauty case in cotone biologico con tirazip coordinato | Toilet bag with matching puller.

Cotone Organico | Organic Cotton

21 x 16 cm

180 gr/m²



43210
Olmo



Beauty di cotone organico, tirazip coordinato. Può essere realizzato in colore pantone a partire da 650pz. | Toilet bag made of organic cotton, matching zipper puller. From 650pcs can be produced in pantone color.

Cotone Organico - 280gr/m² | Organic Cotton - 280gr/m²

21 x 16 cm

280 gr/m²



43219
Astilbe



Beauty in cotone riciclato. | Toilet bag made of recycled cotton.

Cotone riciclato | Recycled cotton

20 x 14 x 6 cm

140 gr/m²



43198
Magnolia



Beauty case multiuso con cerniera e tiretto abbinati. | Multipurpose toilet bag with matching zip and puller.

Cotone riciclato | Recycled cotton

21 x 3 x 12 cm

180 gr/m²



.13



.13



43218
Aronia



Beauty in cotone organico, con base rinforzata. Tirazip in corda. | Organic cotton toilet bag and reinforced bottom part. Rope zipper puller

100% Cotone Organico | 100% Organic Cotton

26 x 22 x 4 cm

310 gr/m²



43217
Aquilegia



Beauty in cotone organico. Tirazip coordinato. | Toilet bag made with organic cotton. Matching zipper puller.

100% Cotone Organico | 100% Organic Cotton

20 x 14 x 6 cm

220 gr/m²



43171
Ombra



Beauty bag in cotone riciclato con tirazip in legno. | Toilet bag made of recycled cotton, with wooden puller.

Cotone riciclato - 220 gr/m² | Recycled cotton - 220 gr/m²

20 x 12,5 cm

220 gr/m²



43212
Pitosforo



Beauty fabbricato in Europa realizzato in cotone riciclato. Tirazip coordinato. | Toilet Bag made in made of recycled cotton. Matching zipper puller.

Cotone riciclato - 280 gr/m² | Recycled cotton - 280 gr/m²

21 x 16 cm

280 gr/m²



.13



.13

RPET PURSES AND BEAUTY BAGS

Toilet bags with main compartment and front pocket with matching color zip.



.01



43165
Arzino

Pochette in RPET con chiusura zip e tirazip in metallo color oro. | Toiletry bag made of RPET with metallic zipper with gold finish.

RPET | RPET
19 x 13 x 4,5 cm



.01



43164
Arnata

Pochette con chiusura zip colorata coordinata | Multipurpose bag with zip closure

RPET 600D | RPET 600D
23 x 15 cm



.02

.03



43215
Bacche

Beauty in Rpet, la versione bianca è ideale per la stampa in sublimazione. | Toilet bag made with RPET, white version suitable for sublimation printing.

RPET 300D | RPET 300D
28 x 15 x 8 cm



.03



43216
Amsonia

Beauty in feltro con tirazip in similpelle | Toilet bag, with synthetic leather handle.

Poliestere RPET 3mm | Polyester RPET 3mm
21,5 x 15 x 2,5



.08



43221
Geranio

Pochette con scomparto principale e tasca frontale con zip e tirazip colorati coordinati e piccolo manico coordinato. Etichetta esterna con logo RPET. | Toilet bag with main compartment and front pocket with matching color zip and zipper puller and matching carry strap. Outer RPET logo label.

Poliestere 210D | 210D polyester
21 x 8 x 13 cm



.01

.23

.04

.02



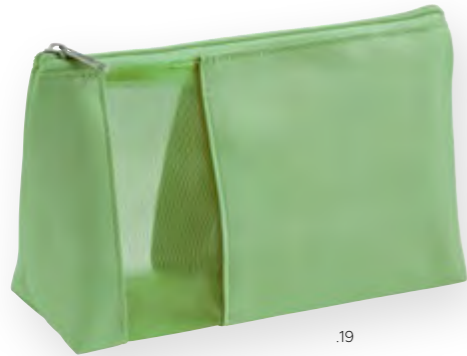

43035
Rufus

Pochette con scomparto principale con zip. Inserto semitrasparente | Beauty bag with main compartment with zipper closure. Translucent detail.

Microfibra | Microfiber

21 x 13 x 8,5 cm



43092
Ogier

Pochette con chiusura zip colorata coordinata. | Toiletry bag with zipper closure in matching colour.

Poliestere 600D | 600D polyester

13,5 x 9,5 x 5 cm



43180
Ciliegia

Beauty case con cerniera, con manico in tinta. | Beauty bag with zipper and puller in matching color.

Poliestere 600D | 600D polyester

22 x 6 x 14 cm



43182
Cipolla

Beauty case con zip e pratico manico di trasporto. | Beauty bag with zip and practical carrying handle.

Poliestere 600D | 600D polyester

20 x 8,3 x 9,8 cm



43995
Belgrado

Pochette con chiusura zip colorata coordinata. Dettagli in PU all'estremità della zip e sul fronte. | Toiletry bag with zipper closure in matching colour. PU details at the end of the zipper closure and on the front.

Poliestere, Similpelle | Polyester, Leatherette

21 x 12 x 6 cm



43065
Anne

Pochette con bordi e dettagli in PU. Ampio scomparto principale con chiusura zip. Tasca frontale con zip. | Toiletry bag with polyester body with PU leather edges and details. Large main compartment with zipper closure. Front pocket with zip.

Poliestere 600D, Similpelle | 600D Polyester, Leatherette

28 x 16 x 7 cm

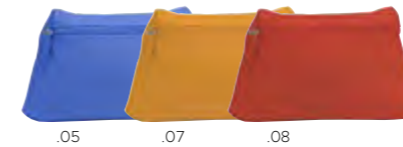

43080
Relf

Pochette. Chiusura con zip colorata coordinata. | Beauty bag with matching colour zipper.

Poliestere 600D | 600D polyester

22 x 14 x 6 cm



UNISEX TOILETRIES BAGS

Practical and spacious unisex toiletries bags, with various compartments to carry your toiletries neatly.



43236
Dalian

Beauty case unisex, chiusura zip. Vari scomparti. Ha un attaccapanni per poterlo appendere. Tasca frontale con chiusura zip. | Unisex beauty case, zip closure. Various compartments. It has a coat rack to hang. Front pocket with zip closure

Poliestere | Polyester

20 x 16 x 7 cm



.05

RECYCLED DENIM



43256
Piovene



Pochette con cerniera e tirazip coordinati. | Clutch bag with zip and matching zip puller.

Cotone, Denim riciclato - 250 gr/m2 | Cotton, Recycled Denim - 250 gr/m2

22 x 5,5 x 16 cm



.16

.26

.05



43223
Annatto

Pochette con cerniera a contrasto e tirazip colorato coordinato. Effetto spugna. | Beauty case with towel texture. With contrasting zip and coordinated colored zip puller.

Poliestere | Polyester

25,5 x 20,5 cm



.01

.08



.05



41122
Galtelli

Pochette con chiusura con zip. | Toiletry bag with zipper closure.

Nylon | Nylon

20 x 10 x 10 cm

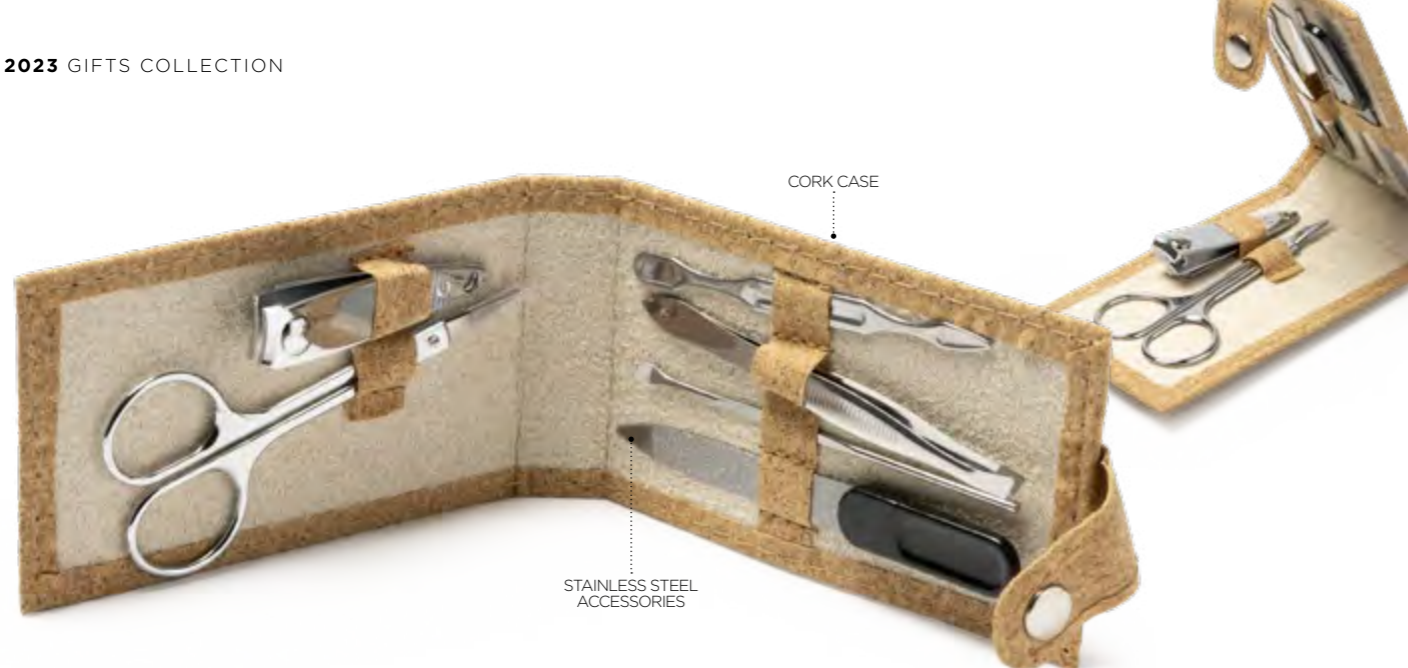

CORK CASE

STAINLESS STEEL ACCESSORIES



44317
Ferrara



Kit per manicure con custodia in sughero e chiusura con bottone a pressione. Comprende forbicine in acciaio inossidabile, pinzette, tagliaunghie, lima e taglia cuticole. | Manicure kit with cork case and snap button closure. Includes stainless steel scissors, tweezers, nail clippers, file and cuticle cutter.

Sughero | Cork

11 x 6 cm



.11



.13



44318
Illasi



Kit per manicure in pouch di cotone con coulisse. Composto da lima per unghie e tagliaunghie. | Manicure kit in cotton drawstring pouch. Consisting of nail file and nail clipper.

Cotone | Cotton

12 cm



.00



44296
Carvi

Lima multiuso con cordino in cotone. | Multipurpose nail file with cotton cord.

Carta vetrata, Bamboo | Sandpaper, Bamboo

10,5 x 4 cm



4 PIECES

.21



44023
Nina

Set Manicure, 4 pz. Include forbicina, spingi cuticole, pinzetta e taglia unghie. | Manicure set 4pcs. Includes scissors, cuticle pusher, tweezers and nail clipper.

Plastica | Plastic

10 x 5,4 x 2,1 cm



5 PIECES

.06

.08

.05



44020
Lime

Set manicure 5 pezzi. Include pinzette, bastoncini per cuticole, limetta e tagliaunghie. Fornito in pouch in nylon. | Manicure set 5 pcs. Includes tweezers, cuticle sticks, nail file and nail clipper. Presented in a nylon pouch.

Nylon | Nylon

5,5 x 14 x 1 cm



4 PIECES

.02



44033
Guardavalle

Set Manicure, 4 pz. Include forbicina, spingi cuticole, pinzetta e taglia unghie. | Manicure set 4pcs. Includes scissors, cuticle pusher, tweezers and nail clipper.

Pvc | pvc

6,6 x 10,5 cm



WHEAT FIBER



.13



42102
Belluno

Pettine | Comb
Fibra di grano, PP | Wheat fiber, PP
[] 2,7 x 17 cm



42112
Bali

Spazzola per capelli | Wooden pring brush.
Legno | Wood
[] 13,5 x 3 x 4 cm



.00

.02



.11



42061
Sovizzo

Pettine con manico. Fornito in confezione dal design eco. | Comb with handle. Supplied in eco-designed packaging.
Bamboo | bamboo
[] 3,5 x 18,4 cm



42054
Peleo

Pettine | Comb
Bamboo | bamboo
[] 14 x 4,5 cm



.11



42058
Arsiè

Spazzola con molte setole per spazzolare più facilmente | Brush with lots of bristles for easier brushing
Bamboo | bamboo
[] 6 x 20 x 1,1 cm



.11



.11



42062
Tramigna

Pettine fornito in confezione dal design eco. | Comb supplied in eco-designed packaging.
Bamboo | bamboo
[] 13,8 x 3 cm



42103
Belmopan

Pettine | Comb
Legno | Wood
[] 12,5 x 5 cm



.11



42131
Tormenta



Specchio oversize realizzato in bambù. Ampia area di stampa sul retro. | Oversized mirror made of bamboo. Wide printing area on the back.

Bambù | bamboo
10 x 22 x 0,8 cm



.11



42003
Else

Specchietto da borsetta con finitura satinata. | Folding mirror in a wide range of bright frosted colours.

Plastica | Plastic
Ø 6 x 0,5 cm



42209
Osvaldo

Specchietto da borsetta con finitura in PU opaca. | Metallic mirror with a matt metallic PU finishing.

Metallo, Pu | Metal, Pu
Ø 6 x 1 cm



NATURAL CORK



.11



42000
Bixo

Specchietto pieghevole realizzato in sughero naturale e metallo cromato. Due specchi interni: 1X / 2X | Nature line folding mirror made of natural cork and chromed metal. Two inside mirrors: 1X / 2X

Sughero | Cork
2 x Ø 6,1 cm



.00



42101
Aneto



Specchietto | Mirror
Legno | Wood
Ø 7 x 0,9 cm



.02



44127
Brian

Specchietto da borsetta con elegante finitura bianca in PU. Con due specchietti: 1X e ingrandimento 2X. | Folding mirror in an elegant white PU leather finish. With two inner mirrors: 1X and 2X magnifying.

Similpelle | Leatherette
0,9 x Ø 6,5 cm



.01

.16

.32



42127
Avventurina

Specchietto da borsetta, con finitura metallizzata. | Mirror with metallic finish.

Plastica | Plastic
Ø 6,6 cm





42002
Susi

Spazzola pieghevole con specchietto. | Folding brush with mirror

Plastica | Plastic

∅ 6,6 x 2,8 cm



42043
Grundtal

Spazzola con sistema districante e denti in diverse lunghezze. | Minimalist design brush with anti-tangle system and spikes in different lengths.

Plastica | Plastic

6,7 x 9 x 4,5 cm



42042
Lisabo

Spazzola per capelli | Hairbrush

Plastica | Plastic

7,3 x 18,5 x 3,6 cm



42208
Portento

NEW

Spazzola per capelli a forma di goccia, con finitura metallizzata. Denti a 3 lunghezze. Fornita in scatola in plastica | Drop-shaped hair brush with updated finish in metallic colours. Tooth at three heights. Presented in transparent plastic box

Plastica | Plastic

6,5 x 8,8 x 4 cm



42114
Galluccio

Spazzola per capelli con specchio incorporato | Hairbrush with built-in mirror.

Plastica | Plastic

15 x 7,5 x 3 cm





43257
Quarto



Set composto da spazzolino da denti e clessidra. Fornito in una pouch con chiusura con zip. | Set consisting of toothbrush and hourglass. Supplied in a zip lock pouch.

Bamboo, Plastica, Cotone | Bamboo, Plastic, Cotton

Case: 20,5 x 7 cm / Brush: 2 x 17,5 cm / Hourglass: 2,5 x 8,5 cm



.13

.09



43154
Lama



Spazzolino con setole colorate. Con cappuccio protettivo. Fornito in confezione color avana. | Toothbrush with colour bristles, and protector cap. Presented in a kraft box.

Bamboo | bamboo

16,5 x 1,5 cm



43992
Bellizzi



Spazzolino da denti, fornito in confezione singola | Toothbrush made of natural bamboo wood, presented in a individual Kraft box.

100% Bamboo | 100% Bamboo

1,4 x 17,5 cm



43026
Cruz

Portaspazzolino con clessidra | Toothbrush holder with hourglass

Plastica | Plastic

14 x 8,5 x 6,5 cm



43235
Harbin

Set per la pulizia interdentale, include custodia con chiusura di sicurezza. | Interdental cleaning set, includes case with safety lock.

PP | PP

8,1 x 3 cm

WHEAT FIBER



43167
Valiuma



Spazzolino richiudibile realizzato in PP e in fibra di grano antibatterici. | Foldable toothbrush made of PP and antibacterial wheat fiber.

Fibra di grano, PP (antibatterico) | Wheat fiber, PP (antibacterial)

10x2,2x1,2 cm(closed) - 15,5x2,2x1,2 cm(open)

PLA 100% COMPOSTABLE



43196
Bella di notte



Spazzolino da denti in PLA. Setole bianche di durezza morbida. | Toothbrush in PLA. Soft white bristles.

PLA 100% Compostabile | PLA 100% Compostabile

18,4 x 1,4 x 1,6 cm



.08 .07 .18 .04 .02



48004
Sara

Spazzolino da viaggio con finitura soft touch. | Collapsible toothbrush with soft touch finishing.

Plastica | Plastic

9x2x1,5 cm



.02



43128
Teddy

Spazzolino pieghevole da viaggio | Foldable toothbrush

Pvc | pvc

8,5 x 1 x 1 cm



.06 .05 .07 .04 .08



43002
Elias

Spazzolino da denti per bambini. Ventosa alla base | Toothbrush With suction cups on the base.

Plastica | Plastic

3 x 14,6 x 1 cm



BAMBOO

.00



72022
Wuxi



Bilancia pesapersona con display digitale. Piedini antiscivolo. Dotata di misuratore di temperatura ambientale. Portata massima 180kg. Alimentata con 2 batterie AAA (non incluse). | Bathroom scale, with digital display. Non-slip base. Equipped with an ambient temperature meter. Maximum weight 180kg.

Bamboo | bamboo

28 x 28 x 3 cm



MAXIMUM WEIGHT 180KG



TRASPARENTE POUCH



.08 .04 .06 .05



43133
Greccio

Set composto da spazzolino e clessidra, Spazzolino con ventosa alla base. Clessidra da 2 minuti. Fornito in pouch singola | Set of toothbrush and sand timer clock in bright tones. brush suction cups on the base; and 2 minute sand timer clock. Presented in an individual bag with zipper.

Plastica | Plastic

8 x 20 x 2 cm

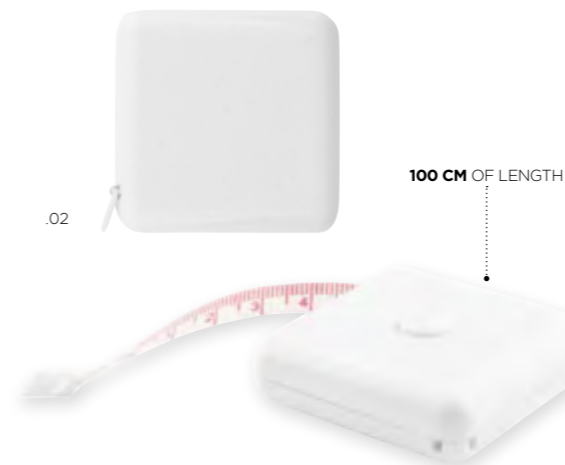

100 CM OF LENGTH

.02



47150
Kinabalu

Metro da 100cm. Sistema metrico in centimetri e pollici. Riavvolgibile con bottone. | Measuring Tape with 100cm of length. Metric system in centimetres/inches. Retractable with button.

Plastica | Plastic

4,5 x 4,5 cm



150 CM OF LENGTH

.02



47157
Delta

Metro a nastro rifinito in similpelle di 150 cm di lunghezza. | Tape measure finished leatherette 150 cm in length

Similpelle | Leatherette

5 x 5 x 1,5 cm



44011
Loeb

Burrocacao semitrasparente con SPF 15 | Lipbalm, SPF 15 protection
Plastica | Plastic
6,8 x Ø 1,9 cm



44130
Lampo

Burrocacao classico con tubetto con finitura metallizzata, all'aroma di vaniglia. Protezione SPF15. | Lip balm in a tube with a metallic finishing, with vanilla flavour. SPF15 protection.
Abs | Abs
Ø 1,9 x 7 cm



44038
Bernina

Burro cacao. Aroma vaniglia. SPF15. | Lipblam. Vanilla flavour. SPF 15.
Fibra Bamboo, Abs | Bamboo fiber, Abs
7 x Ø 1,9 cm

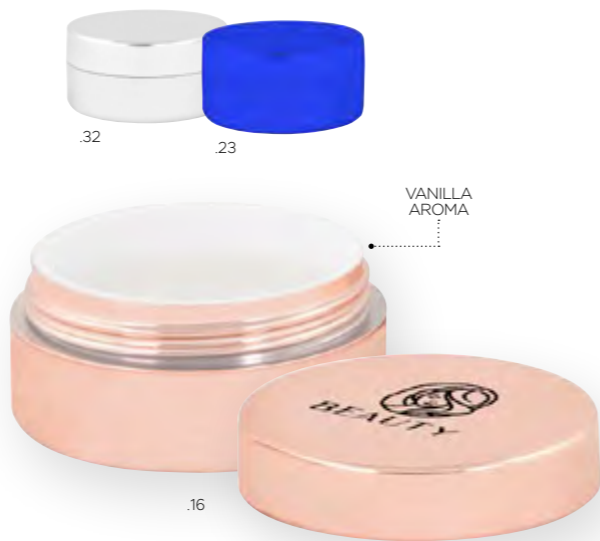

44126
Azzurrite

Burrocacao in vasetto con finitura metallizzata. Profumato alla vaniglia. Protezione SPF. | Lip balm with metallic plastic box. With vanilla flavour. SPF protection.
Abs | Abs
Ø 3,5 x 1,8 cm

LIP BALMS WITH VANILLA FLAVOUR

Sphere of lip balms in elegant colours. SPF15 protection and dermatologically tested



44100
Bellona

Burrocacao sferico. Profumo di vaniglia, protezione SPF15. | Sphere of lip balms in elegant colours golden, silver and pink golden. Vanilla flavour, with SPF15 protection and dermatologically tested.

Plastica | Plastic
Ø 3,8 cm





Massaggiatore facciale Guasha. | Guasha facial massager.

Pietra naturale | Natural stone

4,5 x 7 cm



Scaldamani riutilizzabile effetto riscaldante, lunga durata. | Reusable thermal patch with heat effect, long lasting.

Plastica | Plastic

8 x 10 x 1 cm



Massaggiatore a rullo per il viso, in giada naturale | Facial massage roller, made with natural jade.

Giada, Metallo | Jade, Metal

5,5 x 10,5 cm



Massaggiatore | Cherry wood massager roller.

Legno di ciliegio | Cherry wood

15 x 2,5 x 8 cm

NATURAL CORK



Palline da massaggio in sughero per schiena, spalle, piedi e altro. Include due palline, fornite in un sacchetto di cotone. | Cork massage balls for back, shoulder, foot among others. Includes two balls and a cotton bag.

Sughero | Cork

Ø 6 cm



Massaggiatore per cuoio capelluto, con punte in silicone per massaggiare. | Scalp massager, with silicone tips for massaging.

PP, Fibra di grano, Silicone | PP, Fiber Wheat, Silicone

Ø 8 x 7 cm



6 LIVELLI DI FREQUENZA DI VIBRAZIONE
6 LEVELS OF VIBRATION FREQUENCY

4 TESTE DIVERSE
4 DIFFERENT HEADS

.32

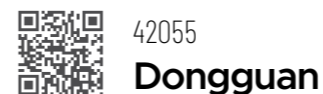
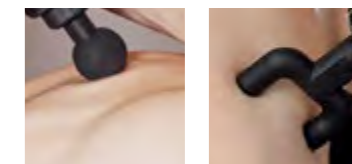

Pistola per massaggio corpo e viso, 6 livelli di intensità, 4 accessori. Ricaricabile tramite cavo. | Body and face massage gun, 6 intensity levels, 4 accessories. Rechargeable via cable

Plastica | Plastic

17 x 21 cm





.06



.00



43036
Hilla

Set bagno per bambini in zainetto. Include manopola, spugna e una paperella. | Children bath set in backpack with duck theme. Includes mitt, sponge and a duck.

Vario | Varied

📏 26 x 18 x 9,5 cm



42056
Arsiero

Spugna da bagno con laccetto | Bath sponge with string

Polietilene | Polyethylene

📏 Ø 10 cm / Nastro: 4 x 2 cm

NEW



.09



.17



.00



46070
Iodo

Spugna 20gr | Sponge 20gr

Vario | Varied

📏 Ø 9,7 x 8 cm



18050
Bauska

Asciugamano a forma di rosa con gambo. | Towel in a rose shape with stem.

100% Cotone | 100% Cotton

📏 23 x 5,5 cm



43209
Banano



Luscino terapeutico per il collo, aroma di lavanda, fornito con una fodera di cotone. | Therapeutic cervical cushion with lavender scent, presented in a cotton cover.

Semi di grano e lavanda naturale, Tessuto cotone | Wheat seeds and natural lavender, Cotton fabric

📏 48 x 15 cm



YOUR BESPOKE TISSUE BOXES

Customizable all over



- Scegli o crea la forma su misura per il tuo box**
Select the size and box shape or create your own one
- Applica il tuo design in base alle tue esigenze...**
Insert your design based on your needs



Verifica modelli e disponibilità sul sito web!
Check all the available models on our website!



.00



43258
Creazzo



Shampoo vegetale solido da 40 g al profumo di giacinto, fornito in pouch. Ogni tavoletta equivale a 125 ml di shampoo liquido. | 40 g solid vegetable shampoo with hyacinth scent, supplied in pouch. Each tablet is equivalent to 125ml of liquid shampoo.

RSPO vegetale sindopale, 1% giacinto 722 | RSPO vegetable sindopal, 1% hyacinth 722

Soap: 5 x 5 x 1,2 cm / Bag: 9 x 10,5 cm



.00



43199
Mesembriantemo



Sapone vegetale prodotto in Europa, fornito in sacchettino con chiusura con coulisse. | Vegetable soap made in Europe. Presented in a drawstring cotton bag.

Vegetale | Vegetable

Ø 6,5 x 1 cm, Bag: 9 x 10,5 cm



.13



50999
Bellusco



Ciabbatine. Suoletta spessa 5mm. | High quality slippers. Sole of a thickness of 5mm.

Cotone | Cotton

Sizes 39 / 43



.00



42051
Barbabietola



Spugna esfoliante naturale con un manico piatto in legno per una facile presa e un laccetto per appenderla. | Natural scrub sponge with flat wooden handle for easy grip and hanging rope.

Luffa, Legno | Luffa, Wood

7 x 37 x 7 cm



.00



42052
Berberidopsis



Spugna Konjac con sacchetto di cotone in rete per una migliore ventilazione. | Konjac sponge with half cotton and half mesh bag

Konjac | Konjac

Bag: 11 x 12,5 cm / Ø 7 x 3,5 cm



.00



42049
Bagolaro



Spugna esfoliante con fascia elastica per una migliore impugnatura. | Sponge and scrub with elastic band for easy handling.

Cotone | Cotton

11 x 15 cm



.02

.01



50044
Cleo

Ciabbatine unisex realizzate in comodo cotone/poliestere con interno imbottito. Include una pratica pouch in TNT. Taglia unica 36-43. | Unisex hotel slippers in comfortable cotton/polyester with padded lining. Practical non-woven pouch included. One size (36 to 43).

Cotone, Poliestere. | Cotton, Polyester.

One size Size 36-43





.13



43168
Trota



Set composto da 2 dischetti struccanti riutilizzabili, fornito in pouch di cotone con chiusura con coulisse. | Set of two reusable make-up remover disks, presented in a cotton bag with drawstring closure.

Bambù, cotone | Bamboo, cotton
 [] Disk: Ø 8 cm / Bag: 11 x 12 cm



.16



44295
Carum

Spugnetta per il makeup con coperchio e cordino. | Makeup sponge with cover and lanyard.

Spugna, PE | Sponge, PE
 [] Guaina: Ø 5 x 7 cm / Spugna: Ø 4 x 7 cm



.11



44316
Arzignano



Pennello da trucco con morbide setole | Soft bristle makeup brush

Legno di faggio, setole sintetiche | Beech wood, synthetic bristles
 [] 2 x 10,5 cm



.02



18089
Piombino



Accappatoio da doccia | Bathrobe

Microfibra | Microfiber

[] S/M - L/XL



10 ml



.08

.15

.03



43234
Nanchino

Spruzzino retrattile con meccanismo a torsione, girando il meccanismo lo spruzzino rientra a scomparsa. Capacità 10ml (liquido non incluso) | Retractable sprayer with torsion mechanism, by turning the mechanism the sprayer retracts and retracts. Capacity 10ml (liquid not included)

Plastica | Plastic
 [] Ø 2,2 x 10,9 cm



10 ml



.13

MADE OF BAMBOO



43248
Asolo



Flacone spray da 10 ml | 10 ml spray bottle
 Bamboo, vetro, polipropilene | Bamboo, glass, polypropylene

[] 1,8 x 10 cm



.02

.01

.03



42064
Zoppè



Fascia con chiusura in velcro realizzata in spugna. | Headband with Velcro closure made of sponge.

Poliestere, Poliammide | Polyester, Polyamide

[] 8,5 x 69 cm



.31

.01



42057
Asiago



Elastico per capelli con etichetta in tessuto per la personalizzazione | Hair elastic band with label for personalization

Raso | Satin

[] Ø 5 cm / Elastic: 3 cm



.11



41139
Arzergrande



Braccialetto realizzato in legno. Particolarmente adatto all'incisione laser. | Bracelet made of wood. Particularly suitable for laser engraving.

Legno di acacia nilotica | Nilotic acacia wood

[] 8,4 x 8,4 x 2,2 cm

NYLON WALLETS

With inside compartments and keychain.



41116
Azov

Portafoglio con tasche interne, una aperta e una con zip. Anellino portachiave interno. Chiusura con velcro. | Wallet with inside pockets, one open and one with zipper closure. Inside keyring. Velcro closure.

Nylon | Nylon
12,5 x 8 x 1,4 cm



.45



41118
Tolyatti

Portafoglio con scomparto interno per banconote, tasca per monete con chiusura in velcro, e scomparti per carte. Chiusura in velcro. | Wallet with inside compartment for bills, coin pocket with velcro closure and cards compartment. Velcro closure.

Nylon | Nylon
12,5 x 9,5 cm



.45



.45



41117
Toksovo

Portafoglio con tasche interne. Anellino portachiave interno. Chiusura con velcro. | Wallet with inside pockets. Inside keyring. Velcro closure.

Nylon | Nylon
8 x 4,5 cm



41125
Gamberale

Portachiavi a forma di borsetina con chiusura zip. | Keychain in handbag shape with zipper closure.

Nylon | Nylon
10 x 5,5 cm



.45



.31 .32



.08 .02



.01



.13



.01



43125
Genova

Portamonete con finitura metallizzata e tirazip in metallo. | Pvc coin purse with metallic finish and a metallic pull tab.

Similpelle | Leatherette
12 x 8 cm



41143
Revine

Portamonete con tirazip con dettaglio color oro. | Coin purse with zip puller with gold-colored detail.

Cotone riciclato - 280 gr/m² | Recycled cotton - 280 gr/m²
13 x 3 x 9 cm



42060
Omlopp

Portamonete, con chiusura zip, tirazip in PU | Coin purse with zipper closure, with PU puller

Cotone - 220 gr/m² | Cotton - 220 gr/m²
11 x 2,5 x 9 cm



.02 .08 .01



.23 .06 .07



.17 .04



41134
Jayson

Portamonete con portachiavi integrato. Chiusura con zip colorata coordinata. | Coin purse with integrated key ring. Closure with coordinated colored zip.

Similpelle | Leatherette
10,5 x 0,5 x 7,5 cm



RECYCLED PLASTIC



.02 .23 .08



.04 .01

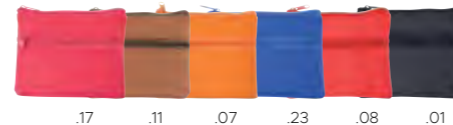

.17 .11 .07 .23 .08 .01



.04 .06



.08



43189
Ciro

Pochette con doppia cerniera in tinta. | Pouch with matching double zip.

Similpelle RPET | RPET leatherette
10,5 x 9 cm



41793
Öludeniz

Porta monete. Scomparto unico e tasca frontale con chiusura zip coordinata. Foderata interna coordinata. | Coin purse with main compartment and front pockets with matching zipper closure.

Similpelle | Leatherette
10,5 x 9 cm



41040
Hele

Portamonete click-clack | Click-clack purse

Nylon 70D | 70D nylon
9 x 7 cm





 49045
Zenz
Cravatta | Tie
Poliestere | Polyester
150 cm



 43222
Anice
Scatolina porta gioielli con specchio nella parte superiore e manico in similpelle per una facile apertura. | Small Bamboo jewelry box with mirror
Bamboo, Similpelle | Bamboo, Leatherette
8 x 4 cm

BEAUTY ACCESSORIES

Small bamboo jewelry box with mirrors.



 43098
Clematide
Pouch con chiusura con coulisse. | Sachet with string closure.
Poliestere | Polyester
9,5 x 10 cm

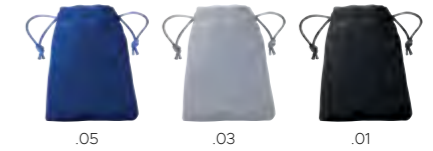

 43094
Urano
Pouch. Chiusura con coulisse colorata coordinata. | Sachet with matching colour ribbon closure.
Floccato | Flocked
8 x 10 cm



 43261
Valdagno
Custodia per gioielli con due cinturini, una tasca aperta e una tasca con zip. | Jewellery case with two straps, one open pocket and one zip pocket.
Cotone - 200 gr/m2 | Cotton - 200 gr/m2
Opened: 18 x 30 cm / Closed: 18 x 10 cm



 41352
Lansing
Pouch portacellulare particolarmente adatta alla sublimazione | Smartphone pouch especially designed for sublimation
Poliestere | Polyester
13 x 8 cm





46935

Bellegra



Portachiavi ottenuto dal taglio del legno di faggio. Disponibile rotondo o ovale. | Keychain Obtained from cuts of beech wood. Available in oval and rounded colours.

Legno | Wood

☐ 0,5 x 4,4 cm (Round) - 6 x 0,3 x 3,5 cm (Oval)



.00C

.00B



82073

Scalogo



Portachiavi con funzione di supporto telefono | Keychain with cell phone holder function

Bambù | bamboo

☐ 8,5 x 4 x 1,6 cm



PHONE HOLDER



.00



.11



46167

Ariano



Portachiavi a forma di casa con un lato in metallo e uno in bambù. | House shaped keyring with one side in metal and one in bamboo.

Metallo, Bambù | Metal, Bamboo

☐ 4 x 7 x 0,3 cm



.11



46168

Arquà



Portachiavi rotondo con un lato in metallo e uno in bambù. | Round keyring with one side in metal and one in bamboo.

Metallo, Bambù | Metal, Bamboo

☐ 4 x 7 x 0,4 cm



.00A

.00B



46166

Darmstadtio



Portachiavi disponibile in due formati con elegante finitura in similpelle | Natural wood keychain in two sizes with elegant leatherette finish.

Legno, similpelle | Wood, leatherette

☐ 8,5 x 0,5 x 3,8 cm (Round)- 3 x 0,5 x 10 cm (Oval)



.00A

.00B



46993

Bellante



Portachiavi realizzato in legno di faggio, disponibile nella forma rotonda o quadrata. | Keychain made of natural beech wood, available in squared and round designs.

Legno | Wood

☐ 7,2x0,6x3,9cm (Round)- 3x0,6x8,8cm (Rectangular)

NATURAL CORK

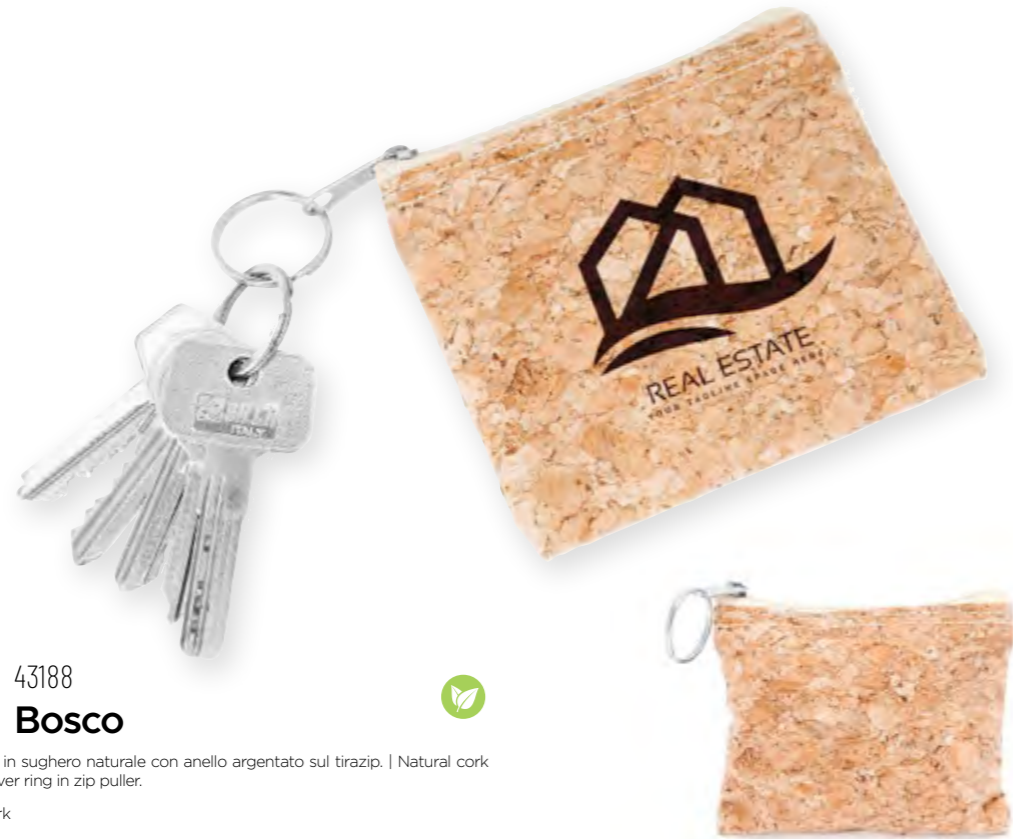

43188
Bosco

Portamonete in sughero naturale con anello argentato sul tirazip. | Natural cork purse with silver ring in zip puller.

Sughero | Cork

10 x 9 x 2 cm



.11



47092
Didi

Portachiavi con nastro in poliestere e moschettone, e laccettino portacellulare. | Keychain with polyester ribbon with carabiner and phone holder

Metallo, Poliestere | Metal, Polyester

9 x 2 cm



47040
Erykha

Portachiavi con moschettone. Con anello portachiavi. | Keyring carabiner with ring.

Alluminio | Aluminum

3 x 5,6 x 0,5 cm

NATURAL CORK



.11



46137
Rybachiy

Portachiavi a forma di tappo, prodotto con materiale naturale. | Oenologist keychain, manufactured with natural materials.

Sughero | Cork

2,3 x 4,5 cm



NATURAL CORK



.00A

.00B



46934
Bellary

Portachiavi, disponibile nella forma rettangolare o rotonda. | Keychain of nature line made of cork. Available in squared and round designs.

Sughero | Cork

Ø 0,6x7,9 cm (Round) - 3,9x0,6x8,1 cm (Rectangular)

NATURAL CORK



.05

.01



46165
Copernicio

Portachiavi galleggiante con cordino robusto in poliestere. | Floating cork keychain with sturdy polyester rope.

Sughero, Poliestere | Cork, Polyester

9 x 4 x 1,5 cm



.08

.16

.01



46172
Monticello

Portachiavi con moschettone, pompon in cotone e targhetta in metallo. | Keychain with carabiner, cotton pompon and metal tag.

Cordoncino di Cotone, Metallo | Cotton Cord, Metal

4 x 15 cm



.05

.08

.01



46171
Maserà

Portachiavi con moschettone. | Keychain with carabiner.

Cotone | Cotton

2,5 x 20 cm





.05 .08 .06



.06 .04 .08 .01



.02



.05



.07

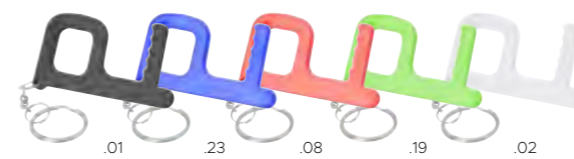

.01 .23 .08 .19 .02



.02 .06 .08 .05 .00



.01



47202
Godiasco

Portachiavi a casco di sicurezza. | Keychain in safety helmet shape

Plastica | Plastic

3,7 x 3,8 x 2,2 cm



49047
Vera

Portachiavi galleggiante | Floating keychain

Eva | Eva

6,8 x 3,3 x 1,4 cm



45010
Seza

Portachiavi galleggiante ad infradito | Floating flip-flop keyring

Eva | Eva

3 x 6,5 x 0,9 cm



44101
Diogene

Portachiavi antibatterico | Antibacterial keychain

Plastica | Plastic

7 x 4 x 0,4 cm



47005
Effi

Portachiave con porta accendino con clip | Lighter holder with keychain and clip

Plastica, Metallo | Plastic, Metal

9 x 3 x 1,5 cm



.05 .06 .04 .07 .08



.48 .02 .58



.08 .23 .03 .01



.32



.23 .08 .07 .19



.01



47143
Aventurine

Portachiavi a forma di fiches | Poker fiches keychain

Plastica | Plastic

Ø 4,2 cm



46152
Clea

Portachiavi bandiera in poliestere con rinforzo in PU. | Polyester keyring with a flag design and PU reinforcement.

Similpelle | Leatherette

12 x 3 cm



47156
Bocca di leone

Portachiavi rettangolare | Elongated textile keychain

Poliestere | Polyester

2 x 8 cm



46059
Roda

Portachiavi con parte centrale girevole. | Keychain with rotating central part.

Metallo | Metal

3,5 x 9,5 cm



46021
Tare

Portachiavi con parte centrale girevole e inserto in PU | Keychain with rotating central part and PU detail.

Metallo | Metal

3,8 x 5,5 x 0,4 cm



.01 .05



Portachiavi con moneta, con luce con 2 LED e moneta removibile. | Keychain coin with 2 LED flashlight and with removable coin.

Plastica | Plastic

7 x 1 x 2,5 cm



.07 .02 .06 .01 .05 .08



Portachiavi con moneta. Moneta removibile. | Keychain coin with removable coin.

Plastica | Plastic

2,9 x 5,7 x 0,4 cm



.01



Portachiavi rettangolare. Fornito in scatola in cartoncino | Rectangular keychain made in pu, with metallic top. Packed in black cardboard box

Metallo, Pu | Metal, Pu

2,5 x 6,5 cm



.01

.32



Portachiavi con parte in metallo. Fornito in confezione singola | Keychain with its upper half in a metallic finish. Presented in a black individual box.

Similpelle, Metallo | Leatherette, Metal

1,8 x 10 cm



Portachiavi in metallo, particolarmente adatto all'incisione laser. | Metal key ring, particularly suitable for laser engraving.

Metallo | Metal

3 x 7,5 cm



.06 .07 .04 .08 .05 .02 .17



.23 .16 .18 .08 .02 .01



.01



Portachiavi con moneta removibile, chiusura con moschettone. | Keychain coin with removable coin and closure carabiner.

Metallo | Metal

Ø 2 cm



NEW

Gancio appendiborsa disponibile in diversi colori. | Bag hanger available in different colors.

Metallo | Metal

4,2 x 0,6 cm



.32



Portachiavi a forma di macchina | Keychain in a car shape

Alluminio | Aluminum

4,5 x 3,6 x 0,2 cm



.32



Portachiavi a forma di automobile. | Car-shaped metallic keychain

Metallo | Metal

4,5 x 2,7 cm





.08 .07 .29 .23 .03



46030
Tami

Portachiavi rettangolare con nastro in poliestere colorato. | Rectangular key chain. Aluminium with coloured polyester webbing

Metallo | Metal

8 x 3 x 0,5 cm



.01



.05 .08 .01



46142
Cirmolo

Portachiavi a forma di macchinina. Fornito in scatola in cartoncino | Car shaped Keychain. Presented in black cardboard box

Alluminio | Aluminum

3,5 x 1 x 2,5 cm



.05 .08 .01



47657
Bonita

Portachiavi a forma di casetta. Laccetto in silicone. Fornito in scatola in cartoncino. | Aluminium house shape Keychain. Tow silicone for keys. Presented in black cardboard box

Alluminio | Aluminum

3,5 x 1 x 3 cm



.02



46133
Chemal

Portachiavi con nastro. Parte centrale in metallo adatta all'incisione laser. | Keychain with ribbon. Central metal part suitable for laser engraving.

Metallo | Metal

9,5 x 3 x 0,5 cm



.08 .07 .29 .06 .05



46007
Temme

Portachiavi con corpo in metallo e nastro colorato, fornito in confezione regalo. | Keychain with metal body and polyester ribbon, supplied in gift box

Metallo | Metal

6 x 2,5 x 0,5 cm



.01 .07 .19 .08 .05



46020
Raba

Portachiavi con parte centrale in metallo e laccetto in silicone. | Keychain with metal central part and rubber string

Metallo | Metal

3,5 x 6,5 x 0,5 cm



.08 .19 .17 .05



47091
Genuri

Portachiavi rotondo con laccetto gommato. Fornito in scatola in cartoncino. | Round keychain with rubber towrope. Presented within a black cardboard box.

Metallo | Metal

Ø 2,5 cm



.06 .00 .02 .09 .11 .40



47201
Jackson

Portachiavi antistress disponibile in vari temi. | Antistress keychain available in different theme.

Gommapiuma | Foam rubber

Ø 4 cm



.07



.01 .02 .06 .23



.08



29184
Venere

Antistress a forma di cubo | Anti-stress cube

Gommapiuma | Foam rubber

4,5 x 4,5 cm



.40



29038
Enri

Antistress a forma di pallone. | Football shaped antistress.

Gommapiuma | Foam rubber

Ø 6,3 cm



.06



.08 .06



.05



.05



.01



47204
Gadesco

Portachiavi antistress a forma di lampadina. | Keychain with antistress in light bulb shape.

Gommapiuma | Foam rubber

6,7 x 3,5 cm



29056
Elsa

Portachiavi antistress | Original anti-stress keychain

Gommapiuma | Foam rubber

3,5 x 8,2 x 1,9 cm



29137
Arda

Portachiavi pallina antistress | Original anti-stress keychain with spherical body

Gommapiuma | Foam rubber

Ø 4 cm



29318
Vigo

Pallina antistress, design pallina da tennis | Stress ball, tennis ball design

Similpelle | Leatherette

Ø 6cm



.06



.02



29241
Celosia

Antistress pillola | Anti stress pill

Gommapiuma | Foam rubber

9 x 5,8 x 5,8 cm

NEW

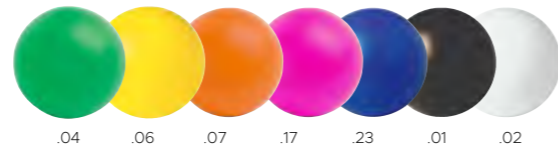

.08



29054
Frek

Pallina antistress | Anti-stress ball
Gommapiuma | Foam rubber
📏 Ø 6,3 cm



.02

.02

.02



29062
Kale

Antistress a forma di maggiolino | Anti stress car
Gommapiuma | Foam rubber
📏 9,5 x 5,5 x 5,2 cm



29228
Praia

Antistress a forma di nave | Boat anti-stress
Gommapiuma | Foam rubber
📏 10 x 5,2 x 5 cm



29068
Ria

Antistress a forma di aeroplano | Anti stress plane
Gommapiuma | Foam rubber
📏 10 x 9 x 4,5 cm



.02

.08



29063
Lovi

Antistress a forma di cuore | Anti-stress heart
Gommapiuma | Foam rubber
📏 7 x 6,7 x 5,4 cm



.18

.08



29151
Tede

Antistress a forma di goccia | Anti stress drop
Gommapiuma | Foam rubber
📏 6,5 x 11 cm



.23

.08



29998
Kungsholmen

Antistress a forma di goccia | Anti-stress droplet, soft body with shiny PU padding.
Gommapiuma | Foam rubber
📏 8 x Ø 6 cm

NEW



44052
Borbera

Penna spray igienizzante mani. Contiene 10 ml di soluzione detergente. | Spray pen cleans and sanitizing hands. 10 ml hand cleansing gel.

Plastica | Plastic

13,4 x Ø 1,6 cm



MADE IN ITALY

500 ML



44083
Beirut

Spray Igienizzante per superfici da 500 ml. Non ha bisogno di risciacquo. | Spray Sanitizer for surfaces, 500 ml

Plastica | Plastic

23 x Ø 6,2 cm



MADE IN ITALY

500 ML

SOAP



44081
Boezio

Sapone Igienizzante Naturale da 500 ml. Rimuove sporco, germi e batteri | Sanitizing soap, 500 ml

Plastica | Plastic

23 x Ø 6,2 cm



MADE IN ITALY

250 ML



44077
Dayron

Gel Igienizzante Naturale da 250 ml con antibatterico naturale. | Sanitizing gel, 250 ml

Plastica | Plastic

19,5 x Ø 4,5 cm



MADE IN ITALY

500 ML



44085
Donnie

Gel Igienizzante Naturale da 500 ml con antibatterico naturale. | Sanitizing gel, 500 ml

Plastica | Plastic

23 x Ø 6,2 cm



44297
Cerio

Gel idroalcolico spray da 10ml con moschettone. | 10 ml hydroalcoholic gel with spray and snap hook

Soluzione idroalcolica 75% alcol, PP, PS | Hydroalcoholic solution 75% alcohol, PP, PS

14,8 x 1,5 x 1,5 cm



44110
Apollo

Flacone gel idroalcolico da 30 ml con erogatore spray. | 30 ml sanitizing gel with spray.

Plastica | Plastic

10,1 x Ø 2,7 cm



MADE IN ITALY



44079
Focus

Gel Igienizzante in tanica da 5 L. con antibatterico. | Sanitizing gel, 5 L

Plastica | Plastic

19,6 x 25,6 x 14,5 cm



MADE IN ITALY



44084
Aureo

Igienizzante per superfici in tanica da 5 L. Non ha bisogno di risciacquo. | Sanitizer for surfaces, 5 L

Plastica | Plastic

19,6 x 25,6 x 14,5 cm



MADE IN ITALY



44089
Baltimore

Sapone Igienizzante Naturale in tanica da 5 L. | Sanitizing soap, 5 L

Plastica | Plastic

19,6 x 25,6 x 14,5 cm





.02



44056
Carlton

Gel igienizzante con dosatore, 500 ml | Sanitizing gel with dispenser, 500 ml

Plastica | Plastic

8,5 x 14 cm



500 ML

100 ML

MADE IN ITALY



.02



44076
Eliseo

Gel Igienizzante Naturale da 100 ml con antibatterico naturale. | Sanitizing gel, 100 ml

Plastica | Plastic

5 x 12 x 3 cm



44299
Cinnamomo

Gel igienizzante per mani 50 ml, in flacone trasparente con tappo bianco. | Hand sanitizing gel 50 ml, in transparent bottle with white cap

Plastica | Plastic

4,5 x 2,9 x 8,5 cm



50 ML



.02



44298
Cesio

Gel idroalcolico da 30ml con custodia in silicone con laccetto per appendere. | 31 ml hydroalcoholic gel

Soluzione idroalcolica 75% alcol, PP, PS | Hydroalcoholic solution 75% alcohol, PP, PS

8 x 3,4 x 2,2 cm



.02



44115
Noete

Salvietta igienizzante 100% compostabile. Confezione da 1 pezzo. | 100% compostable sanitizing wipes.

100% Compostabile | 100% Compostable

6,7 x 8 cm



44177
Saffo

Set di 10 salviette imbevute di Alcohol in una scatola di plastica | Set of 10 alcohol wipes in plastic box

Plastica, No Woven | Plastic, No Woven

6 x 6 x 1,7 cm

30 ML



.23



.08



.02

30 ML



.02



44094
Chuck

Gel per igiene e pulizia della pelle in un flacone da 30 ml. Con moschettone. Soluzione con contenuto alcolico al 65%. | 30ml hand sanitizing solution. Translucent bottle, equipped with a carabiner. 65% ALCOHOL

Plastica | Plastic

3,5 x 10 x 2,2 cm



.02

.08

.04

.23





.08

.02



48052
Dubnio

Kit primo soccorso contiene forbici, strisce, nastro adesivo, alcool, antisettico, garza e bendaggio. | First aid kit contains scissors, strips, tape, alcohol wipe, antiseptic wipe, gauze and bandage.

Poliestere | Polyester

14 x 10 x 4 cm



.08



48057
Ricky

Kit primo soccorso contiene benda in tessuto, 8 tappi per le orecchie, 5 cerotti adesivi, forbici, 4 salviette di alcol, 1 garza sterile e un rotolo di nastro adesivo. | First Aid Kit containing fabric bandage, 8 earplugs, 5 adhesive band-aids, scissors, 4 alcohol wipes, 1 sterile gauze and a roll of tape.

Poliestere | Polyester

13 x 9 cm



.32



48055
Romeo

Kit primo soccorso contiene 1 forbice, 1 nastro, 1 salvietta umida, 3 spille da balia, 2 cerotti e 1 banda garzata. | First aid kit in tin box. Includes: 1 scissors, 1 tape, 1 wet wipe, 3 safety pins, 2 plasters and 1 gauze bandage.

Latta | Tin

9,6 x 6 x 2 cm

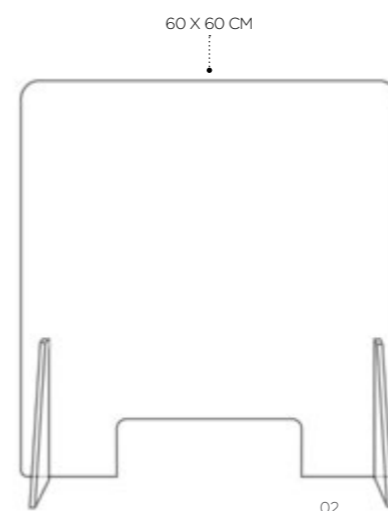

44087
Jhonn

Pannello Parafiato da banco | Breath protection panel

Plexiglass | Plexiglass

60 x 60 cm - Apertura: 25 x 10 cm



48053
Dukkah

Kit primo soccorso contiene benda in tessuto, 8 tappi per le orecchie, 5 cerotti adesivi, forbici, 4 salviette di alcol, 1 garza sterile e un rotolo di nastro adesivo. | First Aid Kit containing fabric bandage, 8 earplugs, 5 adhesive band-aids, scissors, 4 alcohol wipes, 1 sterile gauze and a roll of tape.

Poliestere | Polyester

13 x 9 cm



48006
Idar

Porta cerotti, contiene 5 pz | Plaster holder, including 5 pcs

Plastica | Plastic

4,1 x 10,2 x 1 cm

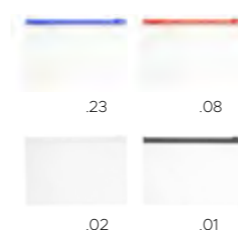

44224
Arlie

Custodia mascherina con chiusura a zip, finitura traslucida. Morbida e pieghevole. | Mask case with zip closure, translucent finish. Soft and foldable.

Pvc | pvc

21,5 x 12 cm



10 WIPES



43021
Flo

Set di 10 tovagliette in cellulosa che si espandono a contatto con l'acqua. Forniti in tubetto trasparente con tappo. | Set of 10 cellulose wipes that expand upon contact with water. Presented in an individual transparent tube with zipper.

Cellulosa | Cellulose

23 cm





PILL BOXES

With compartments and lid.



2 INSIDE BOXES

.02



48033

Mariche

Portapillole, con 2 scomparti, chiusura di sicurezza e lama taglia pillole. | Pill box in soft and resistant material in white. With 2 inside boxes, safety lock and blade to split pills.

Plastica | Plastic

9,5 x 1,6 x 4,8 cm



.02

Antibacterial



48046

Trish

Portapillole antibatterico, finitura solida, con 3 scomparti e chiusura di sicurezza. | Antibacterial pill box in solid finishing. With 3 compartments and safety lock.

Plastica | Plastic

6 x 1,3 x 3,9 cm



.21

.05

.04



.08



48015

Leonz

Portapillole semitrasparente con 3 scomparti con chiusura di sicurezza | Translucent body pill box in vivid colours. with 3 compartments and safety lock.

Plastica | Plastic

6 x 4 x 1,3 cm



.00



48051

Dragoncello

Portapillole con 7 scomparti, uno per ogni giorno della settimana, coperchio scorrevole | Bamboo pill box with 7 compartments according to the days of the week and sliding lid.

Bamboo | bamboo

15 x 2,5 x 4 cm



.00



48050

Disprosio

Portapillole con 3 scomparti, chiusura magnetica | Bamboo pill box with 3 compartments.

Bamboo | bamboo

8 x 2,5 x 4 cm



.32



48021

Ludmi

Portapillole rotondo con 3 scomparti interni. | Round metallic pillbox with three interior compartments.

Metallo | Metal

Ø 4,8 cm

Caps and Accessories

Cappelli da baseball per adulti e bambini, cappelli invernali, bandane, scalda collo e sciarpe.

Baseball hats for adults and children, winter hats, bandanas, neck warmers and scarves.

Caps

and

Accessories





**GOLF CAPS
100% COTTON**

Embroidered eyelets for ventilation. With adjustable velcro closure.



100% COTTON



ADULT SIZE



16036
Resana

NEW

Cappellino 5 pannelli. Chiusura regolabile in velcro e asole. Etichetta rimovibile. | 5 panel cap. Adjustable Velcro closure and buttonholes. Removable label.

Cotone | Cotton

Adulto / Men

5 PAN

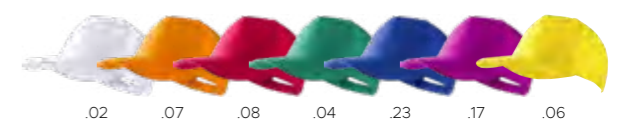
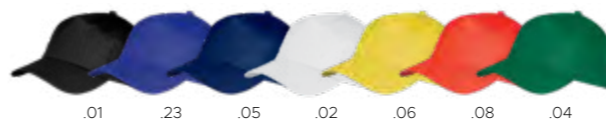

ADULT & KIDS SIZE



KIDS SIZE



16027
Peppino

Cappellino con 5 pannelli. Nastro antisudore | 5 panels cap. Embroidered eyelets for ventilation. Anti-sweatband.

100% Cotone - 170gr/m2 | 100% Cotton - 170gr/m2

Adulto, Bambino / Men, Kids

5 PAN



16133
Ferit

Cappellino 5 pannelli da bambino. Asole ricamate. Chiusura in velcro regolabile. Versione lux. | Kids 5 panel cotton cap. Embroidered eyelets for ventilation. With adjustable velcro closure.

Cotone | Cotton

Bambino / Kids

5 PAN



100% COTTON

ADULT SIZE



16128
Feli

Cappellino 5 pannelli. Asole ricamate. Chiusura in velcro regolabile. Versione lux. | 5 panel cotton cap. Embroidered eyelets for ventilation. With adjustable velcro closure.

Cotone | Cotton

Adulto/Men

5 PAN

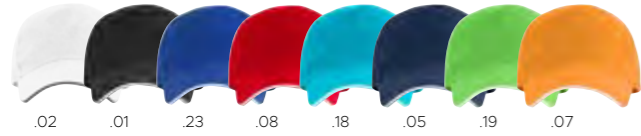

Cappellino 5 pannelli con sandwich in contrasto. Fascia antisudore. Chiusura in velcro. | 5 panels cap with contrast sandwich. Inner sweatband. Velcro fastener.

100% Cotone - 260gr/m2 | 100% Cotton - 260gr/m2

Adulto / Men



Cappellino stile casual 6 pannelli. Parte interna della visiera e fascia antisudore in contrasto. Chiusura regolabile metallica nella parte posteriore. | 6-panel casual style cap. Inner part of the visor and contrast antiperspirant tape to one. Metal adjustable closure on the back.

100% Cotone - 260gr/m2 | 100% Cotton - 260gr/m2

Adulto / Men

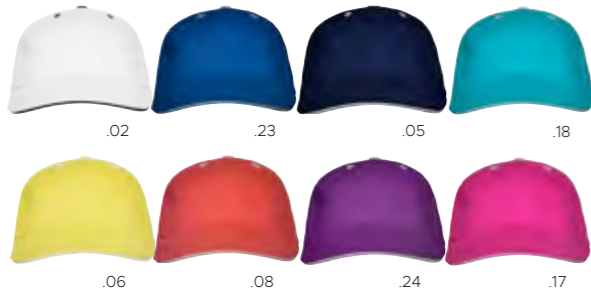

ADULT & KIDS SIZE



ADULT SIZE



Cappellino 6 pannelli con sandwich in contrasto. Fettuccia parasudore interna. Chiusura in velcro. | 6 panels contrast sandwich cap. Inner sweatband. Velcro fastener.

100% Cotone - 260gr/m2 | 100% Cotton - 260gr/m2

Adulto, Bambino / Men, Kids



Cappellino 6 pannelli con sandwich colorato e asole ricamate coordinate. Chiusura in velcro | 6 panel cap in high quality. Coloured sandwich and embroidered ventilation holes in matching colour. Adjustable velcro closure.

Cotone | Cotton

Adulto / Men

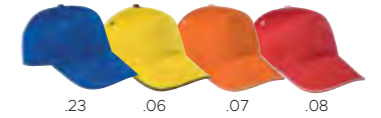

Cappellino 5 pannelli con sandwich. Visiera precurvata con sandwich a contrasto. Asole ricamate coordinate con il sandwich. Chiusura in velcro regolabile. | 5 panel sandwich cap. Pre-curved visor with sandwich. Embroidered eyelets for ventilation in matching colour with sandwich. Adjustable velcro closure.

Cotone | Cotton

Adulto / Men



Cappellino 6 pannelli con sandwich. Visiera precurvata con sandwich. Asole ricamate. Chiusura in velcro. | 6 panel sandwich cap. Pre-curved visor with sandwich. Embroidered eyelets for ventilation. Velcro closure

Cotone | Cotton

Adulto / Men





.13



KIDS SIZE

.23

.18



.23

.02

.01



.90

.16

.23

.02

.01



16074
Ege

Cappello golf 6 pannelli e chiusura con fibbia in metallo | 6 panels golf cap with metal buckle

Cotone Pesante | Heavy Cotton

Adulto / Men

6
PAN



16032
Doruk

Cappellino 5 pannelli con visiera con bordo e piping colorati, chiusura in velcro | 5 panel cap with visor with colored border and piping, velcro closure

Cotone | Cotton

Bambino / Kids

5
PAN



16132
Zurigo

Cappellino dal design sportivo e pratico. Inserti in mesh per favorire la traspirazione. Chiusura in metallo regolabile. | Sportive cap with lateral mesh, with metal adjustable closing.

Poliestere | Polyester

Adulto / Men



16026
Pepsi

Cappellino tecnico con tre pannelli. Tessuto leggero e traspirante. Chiusura regolabile con velcro nella parte posteriore. | Technical cap of three panels. Lightweight and breathable fabric. Adjustable velcro closure on the back.

90% poliestere, 10% Elastan - 140 g/m2 | 90% polyester, 10% Elastane - 140 gr/m2

Adulto / Men

3
PAN



.05

.07

.08

.02

.01



16000
Ginepro

Visiera sportiva con chiusura in velcro e lati imbottiti. | sport visor with velcro closure and padded sides.

Poliestere | Polyester

Adulto / Men



HIGH-VISIBILITY DETAILS



.06

.07



16035
Polo

NEW

Cappellino 5 pannelli con dettagli ad alta visibilità. Chiusura regolabile in velcro e asole. Etichetta rimovibile. | 5 panel cap with high visibility details. Adjustable Velcro closure and buttonholes. Removable label.

Poliestere | Polyester

Adulto / Men

5
PAN



TRUCKER-STYLE CAP

5 panels in 100% polyester.
Back mesh panels.

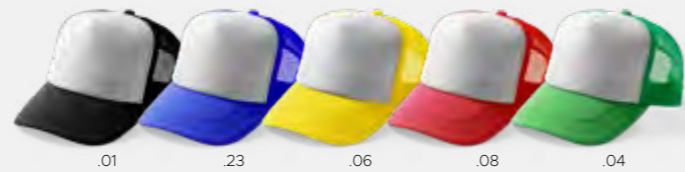

16037
Salzano



Cappellino stile trucker, 5 pannelli. Chiusura regolabile. Etichetta rimovibile.
| Trucker style cap, 5 panels. Mesh back panels. Padded front panel and visor.
Adjustable closure. Removable label.

Poliestere | Polyester

Adulto / Men



16136
Wendover



Cappellino 6 pannelli con pannelli frontali in sughero e parte posteriore in retina in plastica. Chiusura regolabile in plastica. | 6 panel cap with cork front panels and plastic mesh at the back. Adjustable plastic closure.

Poliestere, Sughero | Polyester, Cork

Adulto / Men



.01

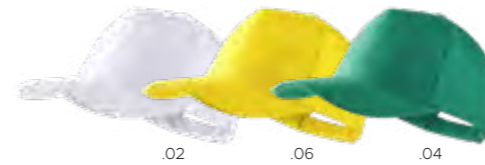

16028
Pelosa

Cappellino 5 pannelli. Fettuccia parasudore interna. Chiusura in velcro. | 5 panels cap. Inner sweatband. Velcro fastener.

80% Poliestere, 20% Cotone | 80% Polyester, 20% Cotton

Adulto / Men



CAP IN 100% ORGANIC COTTON

Velcro fastening and vent eyelets.



ORGANIC COTTON



.13



16064
Aupa



Cappellino 5 pannelli con chiusura in velcro. | 100% organic cotton 5 panel cap with velcro closure

100% Cotone Organico | 100% Organic Cotton

Adulto / Men



RECYCLED COTTON



.04 .02 .01 .23



16039
Torreglia



Cappellino 5 pannelli. Chiusura regolabile in velcro e asole. Etichetta rimovibile. | 5 panel cap. Adjustable Velcro closure and buttonholes. Removable label.

Cotone riciclato | Recycled cotton

Adulto / Men



RECYCLED PLASTIC



.01 .23 .05 .08 .02



16038
Soverzene



Cappellino sportivo traspirante, 6 pannelli. Chiusura con fibbia regolabile e asole. Etichetta rimovibile. | Breathable sports cap, 6 panels. Closure with adjustable buckle and buttonholes. Removable label.

Microfibra RPET | RPET microfiber

Adulto / Men



RECYCLED PLASTIC



.05 .06 .23 .08 .04 .02 .01



16067
Bevera



Cappellino 5 pannelli con chiusura in velcro. | 5 panel cap with velcro closure.

Poliestere RPET | RPET polyester

Adulto / Men



**MOQ
100 pcs**



YOUR BESPOKE CAPS

bespoke
expert in special productions

1

Scegli il tessuto che preferisci

Cotone, Rpet, Poliestere,
Lana ecc...

Select the fabric you prefer

Cotton, Rpet, Polyester,
Wool etc....

2

**Come preferisci
la finitura interna?**

**How would you like
your internal finishing
to look like?**



3

**Applica il tuo logo
in base alle tue esigenze...**
ricamo, serigrafia, logo 3D,
toppa ecc...

**Choose your logo according
to your requirements**
embroidery, screen printing
3D logo, patch etc...



CAPS-1

Cappellino completamente personalizzabile su progetto | Fully customizable cap on project

Cotone | Cotton

Size: Adulto / Men



CAPS-2

Cappellino completamente personalizzabile su progetto | Fully customizable cap on project

Cotone | Cotton

Size: Adulto / Men



CAPS-3

Cappellino completamente personalizzabile su progetto | Fully customizable cap on project

Poliestere | Polyester

Size: Adulto / Men

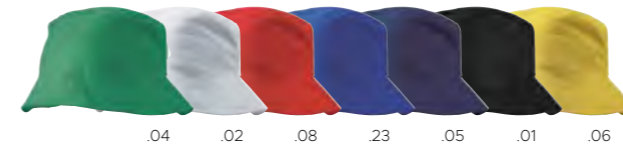

.04 .02 .08 .23 .05 .01 .06



13013
Loo

Cappello modello pescatore | Bob Hat made of cotton

Cotone | Cotton

Size: Adulto / Men



.05 .13



14128
Guallatiri

Cappello da pescatore in cotone e poliestere. | Bob Hat made of with a mixture of cotton and polyester.

Cotone, Poliestere | Cotton, Polyester

Size: Adulto / Men



.13 .70 .05

DUBLE-FACE



.01



14611
Lezig

Cappello modello pescatore, reversibile. Esterno in nylon e interno in morbido e caldo fleece con trattamento anti-pilling. | Reversible bob hat. With outside in nylon and inside in soft and warm fleece with anti-pilling treatment.

Pile, Nylon | Fleece, Nylon

Size: Adulto / Men





 19009
Fraser
Foulard oversize triangolare | Triangle shaped headkerchief
Poliestere | Polyester
 100 x 70 x 70 cm



 49126
Perry
Foulard in forma triangolare | Unisex scarf in triangular shape
Poliestere | Polyester
 100 x 70 x 70 cm



 95013
Greta
Paio di guanti per dispositivi touch screen. Insetto sulla punta del dito indice e pollice. Taglia unica. | Pair of gloves for touchscreen devices, in acrylic. They integrate pointer in fingers heart, index and thumb.
Acrilico | Acrylic
 Unisex



 95124
Pinta
Guanti touch screen, due dita con inserto che permette di utilizzare il touch screen dei vostri device. Colore blu e verde fluo misura uomo, colore fucsia misura donna. | Touch screen gloves, two fingers with insert that allows you to use the touch screen of your devices. Blue and fluo green color for men, fuchsia color for women.
Poliestere | Polyester
 Unisex



 49091
Clelia
Foulard con finitura soft touch | Foulard with soft touch.
Viscosa | Viscose
 70 x 180 cm



 49124
Elio
Scialle con finitura morbida, aspetto cashmere, con piccole frange sui bordi | Acrylic shawl with soft touch cashmere looking finish and short fringes at the ends.
Acrilico | Acrylic
 70 x 170 cm



 49096
Akira
Sciarpa particolarmente adatta alla sublimazione. | Polyester scarf suitable for sublimation.
Poliestere | Polyester
 20 x 150 cm
 180 gr/m

ALTERNATIVE MATERIAL

Classic design, soft and warm.



RECYCLED COTTON



14018
Grignetta



Elegante sciarpa dal design classico. Soffice e calda. | Elegant scarf, classic design, soft and warm.

100% Cotone Riciclato | 100% Recycled Cotton

50 x 180 cm

RECYCLED PLASTIC



49123
Ailanto



Scaldacollo | Neck warmer
RPET Poliestere | RPET Polyester
25 x 50 cm

ORGANIC COTTON

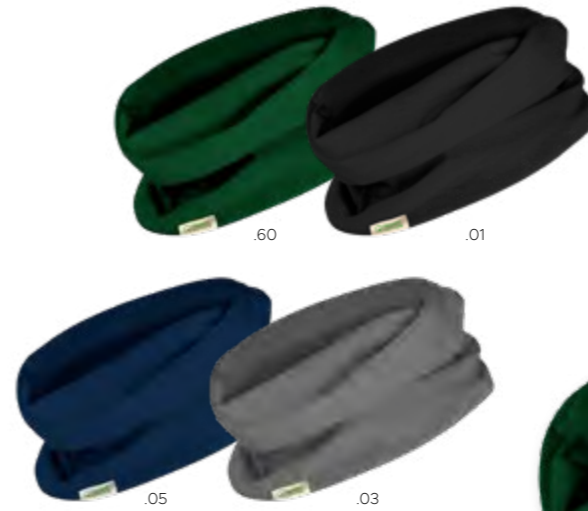

49121
Lentisco



Scaldacollo in cotone organico. | Organic cotton neckwarmer.

100% Cotone Organico | 100% Organic Cotton

25 x 50 cm



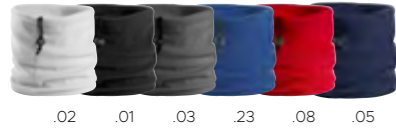

.02 .01 .03 .23 .08 .05



.08 .01 .23 .05

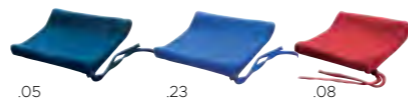

.05 .23 .08



14042
Bismuto

Scaldacollo con coulisse elastica | Fleece neck warmer with elastic regulator.

Fleece | Fleece

26,5 x 22 cm



14739
Oscar

Scaldacollo con trattamento anti-pilling e con coulisse regolabile. | Neck warmer with anti-pilling treatment with string closure

Fleece - 200 gr/m2 | Fleece - 200 gr/m2

26,5 x 22 cm



14772
Oscar Kids

Scaldacollo con coulisse regolabile. | Neck warmer with anti-pilling treatment and string closure

Polar Fleece Anti-Pilling - 200gr/m2 | Anti-Pilling Polar Fleece - 200gr/m2

24 x 22 cm



14774
Beloreck

Cappello in acrilico con inserto frontale per stampa. Doppio strato. | Soft and warm hat in acrylic material. With matching colour front strap for printing and double coverage.

Poliestere | Polyester

19,5 x 19,5 cm



.01 .23 .05 .13



.17 .08 .03 .04



.04 .02 .01 .06
.08 .05 .17 .07



.23



14041
Berkelio

Scaldacollo tubolare multistrato. | Multifunctional tubular neck warmer

Microfibra | Microfiber

25 x 50 cm



.02 .01 .23 .05



.08



14040
Berillio

Cappellino lavorato a maglia con doppio giro sul fondo. | Knitted cap with double loop at the hem.

Maglia | Sweater

20 x 22 cm

Writing and Gifts

Penne a sfera in vari materiali: plastica, metallo, carta, bambù e legno. Penne touch screen, evidenziatori, set penne in confezione regalo e altro...

Ballpoint pens in a variety of materials: plastic, metal, paper, bamboo and wood. Touchscreen pens, highlighters, pen gift sets and more...

Writing

and

Gifts



WHEAT FIBER

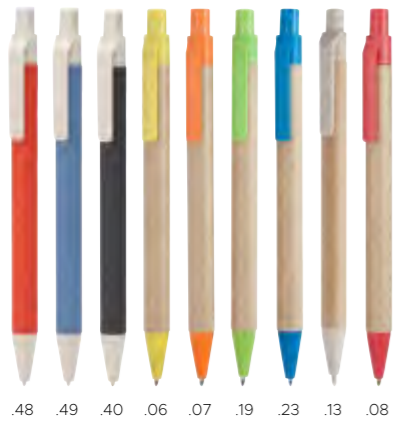

.48 .49 .40 .06 .07 .19 .23 .13 .08



20298
Dafi



Penna a sfera con meccanismo a scatto. Fusto in colore naturale e accessori in fibra di grano e ABS. Logo del materiale fibra di grano sulla parte superiore della penna | Ball pen with push-up mechanism. Combination of body in recycled cardboard and accessories in wheat cane and ABS. Wheat Straw logo on the top of the pen.

Cartone Riciclato, Fibra di grano, Abs | Recycled Cardboard, Wheat Fibre, Abs

13,7 x 0,9 cm



WHEAT FIBER



.18 .17 .00



20285
Salussola



Penna a sfera con meccanismo a scatto, con corpo in cartoncino, e clip e puntale in fibra di grano e PP. | Ballpen with push-up mechanism, with body in cardboard, clip and tip in wheatfiber and PP

Cartoncino, Fibra Di Grano, PP | Cardstock, Wheat Fiber, PP

14,5 cm



WHEAT FIBER



.04 .08 .18 .06 .02 .01



20319
Albero



Penna a sfera a scatto con corpo in bambù, pulsante e puntale in fibra di bambù e clip in metallo. Include puntatore touch. | Retractable ball pen with bamboo body, details in wheat fibre and metallic clip. Touch pointer included.

Bamboo | bamboo

14 x 1,5 cm



WHEAT FIBER



.06 .08 .04 .23 .01



23040
Utby



Penna a sfera con meccanismo a scatto con dettagli colorati. | Push-up mechanism ball pen with accessories in bright tones.

Cartoncino Riciclato | Recycled Cardboard

16,5 cm



WHEAT FIBER



.19 .13 .01 .08 .05



23064
Cervialto



Penna a sfera con meccanismo a scatto, con corpo in cartoncino, e clip, puntale e pulsante in PP e fibra di grano. | Ball pen with push-up mechanism, with recycled cardboard body, and tip, clip and button made of pp and wheat fiber.

Cartone Riciclato, Fibra Di Grano, Abs | Recycled Cardboard, Wheat Fiber, Abs

14 x Ø 1 cm



WHEAT FIBER



.08 .06 .19 .18 .03 .07



23071
Cornappo



Penna a sfera con meccanismo a scatto. Fusto in bambù e puntale, clip e pulsante in fibra di grano e abs. | Ballpen with bamboo barrel with tip, clip and button in wheat straw and ABS.

Bamboo, Fibra Di Grano, Abs | Bamboo, Wheat Fiber, Abs

14 x Ø 1,1 cm



RETRACTABLE BALL PENS

Made of bamboo and wheat fiber.

RECYCLED CARDBOARD

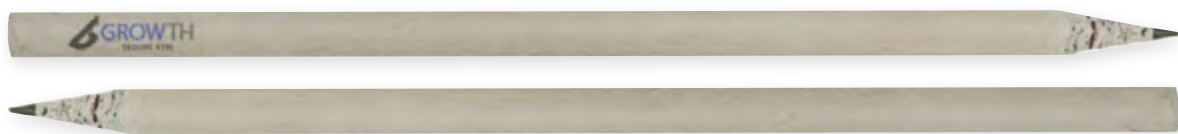

20113
Maska



Matita in carta riciclata, con resistente corpo color natural. | Recycled newspaper pencil with resistant body in natural colour.

Carta Riciclata | Recycled paper

17,5 cm



.00

PLA 100% COMPOSTABLE
RECYCLED CARDBOARD



.02 .01 .08 .04 .23



20306
Darko



Penna con meccanismo a scatto. Fusto in cartoncino riciclato in colore naturale e accessori in PLA. Incisione PLA sulla parte superiore della penna | Ball pen with push-up mechanism. Combination of body in recycled cardboard in natural colour and accessories in PLA. PLA logo on the top of the pen.

Cartone Riciclato, PLA 100% biodegradabile | Recycled cardboard, 100% biodegradable PLA

13,7 x 0,9 cm



PLA 100% COMPOSTABLE



.02 .01 .08 .04 .23



20305
Dante



Penna a sfera con meccanismo a scatto. Fusto in bambù lucido e accessori in PLA. Logo PLA sulla parte superiore della clip | Ball pen with push-up mechanism. Combination of body in glossy bamboo and accessories in PLA. PLA logo on top of the clip

Bamboo, PLA 100% biodegradabile | Bamboo, 100% biodegradable PLA

14 x 1,1 cm



**COFFEE
GROUNDS
PENS**

Made with recycled coffee grounds and ABS, ideal for design lovers.

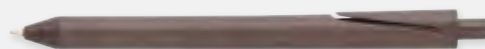

.11



23068
Cinisco



Penna a sfera con clip, realizzata con il 60% di caffè e 40% di plastica Abs | Ballpoint pen with clip. Pen made of 60% coffee and 40% Abs plastic

Plastica, Caffè | Plastic, Coffee

14 cm



WHEAT FIBER



.01 .04 .13 .18



22283

Abbiategrasso



Penna a sfera realizzata con materiale riciclato. Meccanismo a scatto. Clip con ampia area di stampa. | Ball pen with body made of recycled materials, with push-up mechanism and clip with a wide printing area.

Fibra di grano, PP | Wheat fiber, PP

14 cm



WHEAT FIBER



.13



22281

Rezzoaglio



Penna a sfera con meccanismo a torsione. Con gommino per touch screen. | Ballpen with twist action mechanism. With pointer for touch screen.

Fibra Bamboo, PP | Bamboo fiber, PP

14 x Ø 1,3 cm



.13 .06 .07 .08 .23 .04



.01 .08 .04 .06 .07 .13 .18

WHEAT FIBER



WHEAT FIBER



WHEAT FIBER



.13 .06 .07 .08 .18 .04



23825

Comasagy



Penna a sfera a scatto in fibra di grano e ABS. Clip in metallo. | Ball pen with push-up mechanism. Metal clip. With ABS and wheat fiber body.

Fibra di grano, Abs | Wheat Fiber, Abs

Ø 1 x 13,7 cm



WHEAT FIBER



.13



23807

Abdaly



Penna a sfera con corpo in materiale riciclato. Dettagli cromati, meccanismo a scatto, refill jumbo. | Nature line ball pen with body made of recycled materials, in combination of wheat straw and PP. Chromed details and die-cut clip, push-up mechanism.

Fibra di grano, PP | Wheat fiber, PP

14 x 1,3 cm



20331

Anisse



Penna a sfera con impugnatura e clip coordinate. Meccanismo a scatto. | Ballpen with grip and clip in matching colour, with push-up mechanism.

Fibra di grano, Abs | Wheat Fiber, Abs

Ø 1 x 14,5 cm



23073

Corsalone



Penna a sfera in fibra di grano e abs. Meccanismo a scatto. | Ballpen made of wheat straw and abs.

Fibra di grano, Abs | Wheat Fiber, Abs

13,8 x Ø 1 cm



BALL PENS WITH PUSH-UP MECHANISM

Made with cork and wheat fiber.

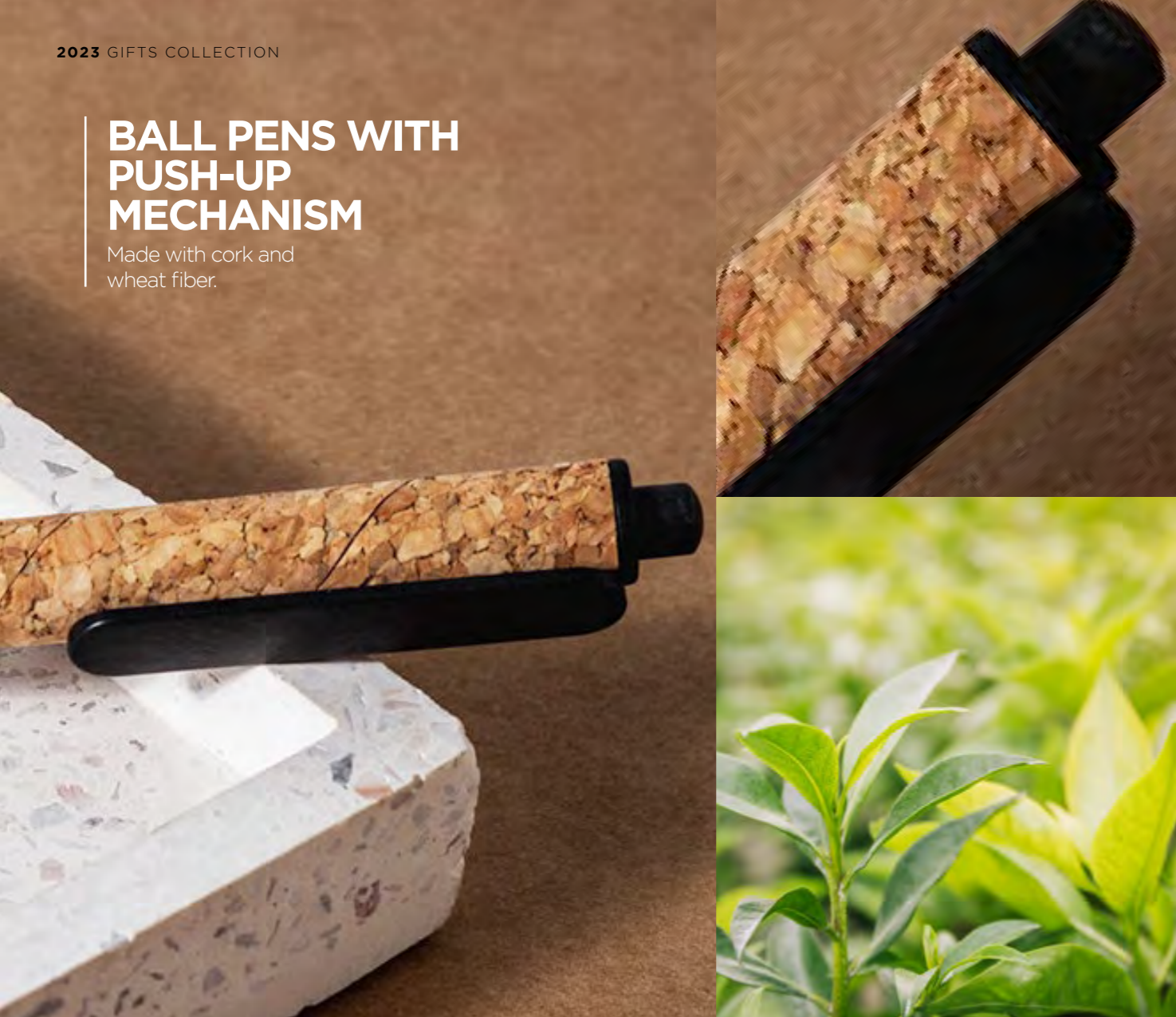

WHEAT FIBER
NATURAL CORK



.13

.01

.19



23811
Jackson



Penna a sfera con meccanismo a scatto, con corpo in sughero, e clip, puntale e pulsante in PP e fibra di grano. | Ball pen with push-up mechanism, with cork body, and tip, clip and button made of pp and wheat fiber.

Sughero, PP, Fibra Di Grano | Cork, PP, Wheat Fiber

14 cm



WHEAT FIBER
NATURAL CORK



.13

.19

WHEAT FIBER
NATURAL CORK



.13

.01

.08

.23

.19



23066
Chiarzo



Penna a sfera con fusto ecologico e particolare in legno | Ball pen with eco barrel and wood detail.

Sughero | Cork

13 cm



23832
Jefferson



Penna a sfera con meccanismo a scatto, con corpo in sughero, e clip, puntale e pulsante in PP e fibra di grano. | Ball pen with push-up mechanism, with cork body, and tip, clip and button made of pp and wheat fiber.

Sughero, PP, Fibra Di Grano | Cork, PP, Wheat Fiber

14 cm





.04 .02 .01 .23 .08



22166
Debbie



Penna con corpo in bambù, puntatore touch screen a colori e clip in metallo. Refill jumbo trasparente da 1,0 mm. | Eco line ballpoint pen with bamboo body, colour touch pointer and metal clip. 1.0mm clear jumbo refill.

Bamboo, metallo | Bamboo, metal

14,8 cm



.01 .50 .23 .08 .04 .11



23803
Flyttbar



Penna a sfera con meccanismo a scatto, in legno di bambù e dettagli in silver lucido. Refill jumbo. | Elegant push-up mechanism ball pen in natural bamboo wood body and shiny silver metallic finish accessories.

Bamboo | bamboo

14 x Ø 1,3 cm



.11



23804
Abashiri



Elegante penna a sfera con meccanismo a scatto, dettagli cromati. Refill jumbo. | Nature line ball pen with body in bamboo wood. Push-up mechanism, with die-cut clip and details in chrome finishing.

Bamboo | bamboo

14 x 1,1 x 9 cm



.13



22061
Nou



Elegante penna a sfera in bambù con dettagli silver. | Elegant ball pen with natural bamboo wood body and silver finish details.

Bamboo | bamboo

14,2 x 1,1 cm



.11



23008
Chicago



Penna a sfera con meccanismo a scatto, in bambù con dettagli silver. Refill jumbo. | Elegant push-up mechanism ball pen in natural bamboo wood body and shiny silver metallic finish accessories.

Bamboo | bamboo

13,5 x 1 cm



.11



23063
Cavetta



Penna a sfera con fusto in bambù. Meccanismo a scatto. | Ballpen with bamboo barrel.

Bamboo | bamboo

13,9 x Ø 1,1 cm



.11



20191
Roswell



Penna a sfera corpo in bambù e gommino per touchscreen. Dettagli cromati. | Ballpen with bamboo barrel and pointer for touch screen. Chromed details.

Bamboo | bamboo

13,5 x Ø 1 cm





22202
Teglio



Penna a sfera in metallo con finitura opaca, impugnatura in bambù e dettagli in colore scuro. | Metal ballpoint pen with matte finish, bamboo handle and dark colored details.

Bamboo | bamboo

14,3 x 1 cm



22837
Mussala



Penna a sfera con meccanismo a torsione, impugnatura in bambù, fusto in alluminio opaco, con gommino touch screen colorato coordinato. | Ballpoint pen with twist mechanism, bamboo handle, matt aluminum barrel, with matching colored touch screen rubber.

Alluminio, Bamboo | Aluminum, Bamboo

14 cm



22179
Crespino



Penna roller con cappuccio. Refill Jumbo | Rollerball pen with cap with jumbo ink

Bamboo | bamboo

13,8 x Ø 1,1 cm



22190
Gaiba



Penna a sfera con meccanismo a torsione, con dettagli in metallo. | Twist action ballpoint pen with metal details.

Sughero, Acciaio | Cork, Steel

13,6 x Ø 1,1 cm



NATURAL CORK



BALL PENS IN RECYCLED ALUMINIUM

With metal details.



.02 .08 .01 .23



20342
Recoaro



Elegante penna a sfera con meccanismo a rotazione, con corpo in alluminio riciclato e dettagli in metallo. Refill jumbo. | Elegant twist mechanism ballpoint pen with recycled aluminum body and metal details. Jumbo refills.

Alluminio riciclato | Recycled aluminum

14,2 x 1,1 cm



.08 .02 .32 .23 .01 .04



20343
Solagna



Penna a sfera con meccanismo a scatto, corpo in alluminio riciclato e pulsante con finitura anodizzata. Refill jumbo. | Ballpoint pen with push mechanism, recycled aluminum body and push button with anodized finish. Jumbo refills.

Alluminio riciclato | Recycled aluminum

14 x 1 cm



MADE OF RECYCLED ALUMINIUM

.32



MADE OF CORK



NATURAL CORK



22199
Campodoro



Penna a sfera con meccanismo a torsione, gommino per touch screen colorato coordinato. Confortevole impugnatura in sughero. Fornita in confezione in sughero, sul retro della quale è stampato il simbolo dell'alluminio riciclato. | Twist action ballpoint pen, matching color touch screen grommet Comfortable cork grip Supplied in cork packaging, on the back of which the symbol of recycled aluminum is printed.

Alluminio riciclato | Recycled aluminum

15,5 x 4 cm



.32



MADE OF RECYCLED CARDBOARD



22200
Campolongo



Penna a sfera realizzata con meccanismo a scatto, fornita in scatola in cartoncino con sleeve. Sulla sleeve è stampato il simbolo dell'acciaio riciclato. | Ballpoint pen made with a click mechanism, supplied in a cardboard box with sleeve. The symbol of recycled steel is printed on the sleeve.

Acciaio Inossidabile Riciclato | Recycled Stainless Steel

17,5 x 5,5 x 2,5 cm



MADE OF RECYCLED STAINLESS STEEL



.18 .04 .21



.21 .23



.02 .01 .18 .23 .04 .07 .08

RECYCLED PLASTIC



RECYCLED PLASTIC



RECYCLED PLASTIC



20281 **Saltrio**



Penna a sfera con meccanismo a scatto. Finitura trasparente. | Ballpen with click action mechanism. Made in PET material. With transparent finish.

PET | PET

Ø 1,1 x 13,9 cm



20329 **Becky**



Penna a sfera, design particolare sul fusto. Clip appositamente realizzata per la stampa. | Ballpen with particular design on body. Clip especially designed for printing.

RPET | RPET

14 cm



20294 **Cuba**



Penna dal design traslucido in materiale rPET. Meccanismo a scatto. | Translucent design pen made from RPET material. Push-up mechanism.

RPET | RPET

Ø 1,1 x 14,2 cm



Perché utilizzare la fibra di pietra?

Materiale estratto dalla pietra naturale, che conserva diverse proprietà come la durabilità e la conservabilità. La scelta più ecologica per sostituire la plastica.

Diventare ecologici è essenziale per la creazione di una terra sostenibile che richieda meno gas serra, conservazione della natura, nessun inquinamento atmosferico e nessun riscaldamento globale. È possibile con l'uso di prodotti riciclati, utilizzando pratiche di riduzione dei rifiuti che rendono il globo un luogo perfetto in cui vivere nelle nuove generazioni.



Why using stone fiber?

Material extracted from natural stone, that retains several properties such as durability and preservability. The most eco-friendly choice to replace plastic.

Going green is essential for the creation of a sustainable earth that requires less greenhouse gases, nature conservation and suffers no air pollution or global warming. It is achievable with the use of recycled products, employing waste reduction practices that make the globe a great place to inhabit for the next generation.

STONE FIBER DURABILITY AND PRESERVABILITY



STONE FIBER



.02 .01 .03



20317 **Dionisio**



Penna a sfera con meccanismo a scatto. Realizzata in fibra di pietra. | Ballpoint pen with push-up mechanism. Made of stone fiber.

Fibra di pietra | Stone fiber

Ø 1,15 x 14 cm





.17 .06 .07 .08 .19 .04 .05 .24 .01



20147
Emma

Penna a sfera design bicolore. Meccanismo a scatto, dettagli cromati, clip in metallo. | Ball pen bicolor design. Push-up mechanism, with chromed details, metal clip.

Plastica | Plastic

14 cm



.02



20274
Gavello

Penna a sfera con meccanismo a scatto, fusto bianco con bandiera stampata. | Ballpen with click action mechanism, white barrel with a printed flag

Plastica | Plastic

13,8 x Ø 1,25 cm



.17 .06 .07 .18 .08 .19 .04 .05 .02 .01



.17 .03 .32 .06 .07 .08 .04 .23 .24

TOUCH SCREEN



.17 .06 .07 .18 .08 .19 .04 .05 .24 .02 .01



20031
Kuk

Penna a sfera con meccanismo a scatto, fusto color silver e impugnatura colorata. | Ballpoint pen with click action mechanism, with plastic silver barrel and coloured grip.

Plastica | Plastic

13,8 cm



20239
Beaumont

Penna a sfera dal design bombato con dettagli silver. Clip in metallo e impugnatura confortevole. | Push-up ball pen with silver coloured accessories and body in solid colours. With original metal clip.

Plastica | Plastic

13,8 cm



20287
Bozzone

Penna a sfera, meccanismo a torsione, clip in metallo, impugnatura gommata, Touch-Screen | Ballpen with rubber grip and rubber tip suitable for touch screens

Plastica, Metallo, Rubber | Plastic, Metal, Rubber

13,3 cm



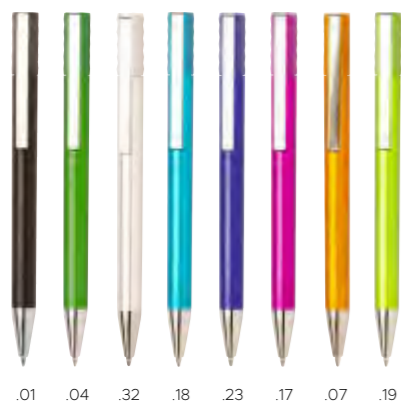

.01 .04 .32 .18 .23 .17 .07 .19



20272
gimigliano

Penna a sfera con meccanismo a torsione, parte alta sagomata e clip in metallo. | Ballpen with twist action mechanism, top part shaped and metal clip.

Plastica | Plastic

14 x Ø 1 cm



.01 .32 .08 23



20337
Praseodimio

Penna a sfera con meccanismo a torsione e finitura metallica. | Ballpoint pen with twist mechanism and metallic finish.

Abs | Abs

15 x Ø 1,1 cm



.08 .06 .07 .02 .03 .01



20289
Burano

Penna a sfera con meccanismo a scatto, pulsante sferico, clip trasparente. | Ballpen with a coloured barrel, push button and transparent clip.

Plastica | Plastic

13,7 x Ø 1,5 cm



.18 .02 .29 .07 .08 .01



20081
Mangal

Penna a sfera a scatto, dettagli bianchi e corpo bombato con finitura liscia tinta unita. | Push-up ball pen of bold bicoulor design with solid white details and curved body of smooth finish in striking solid colours. With original push-up clip ball shaped.

Plastica | Plastic

13,7 x Ø 1,5 cm

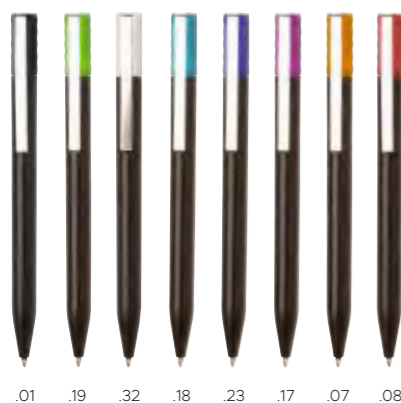

.01 .19 .32 .18 .23 .17 .07 .08



20271
amethyst

Penna a sfera con meccanismo a torsione. Dettaglio colorato nella parte alta, clip in metallo. | Ballpen with twist action mechanism, with black plastic barrel with coloured detail on top, and metal clip.

Plastica | Plastic

Ø1 x 14 cm



.32 .04 .05 .08



20182
Gunnar

Penna a sfera con meccanismo a torsione, design con dettagli silver brillanti e corpo liscio. Clip in metallo. | Twist mechanism ball pen with silver coloured accessories. With metal clip and ring in matching colour.

Plastica, Metallo | Plastic, Metal

13,5 x Ø 1 cm

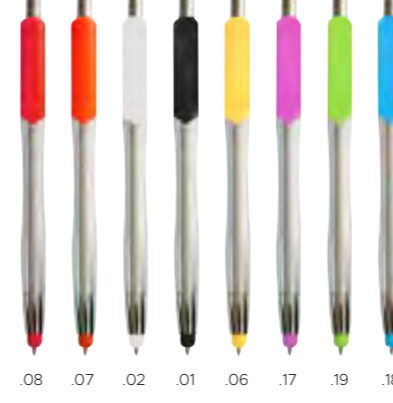

.08 .07 .02 .01 .06 .17 .19 .18



20282
Bianco

Penna a sfera con meccanismo a scatto, con fusto silver, clip e gommino per touch screen colorati e coordinati. | Ballpen with a coloured rubber tip, with silver coloured pusher and tip.

Plastica | Plastic

14 cm

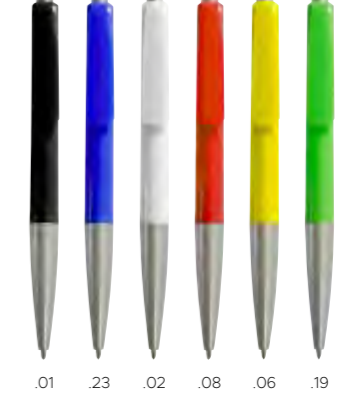

.01 .23 .02 .08 .06 .19 .07



20283
Biscubio

Penna a sfera con meccanismo a scatto, fusto e clip colorati, impugnatura e pulsante silver. | Ballpen with coloured barrel, silver grip

Plastica | Plastic

14 cm





Antibacterial



.02



20318
Cody



Penna a sfera con meccanismo a torsione, design con dettagli silver brillanti e corpo liscio. Clip in metallo. | Twist mechanism ball pen in bicolour design with silver coloured accessories. With metal clip and ring in matching colour.

Abs | Abs

13,8 cm



Antibacterial



.23 .04 .06 .07 .08 .01



20295
Cuccia



Penna antibatterica in ABS e trattata con ioni d'argento. Impugnatura in gomma colorata con finitura traslucida. | Antibacterial ballpen made of ABS and treated with silver ions. Colour rubber handle with translucent finish.

Abs | Abs

13,8 cm

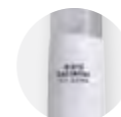

Antibacterial



.02 .01 .08 .23



22193
Gipsy



Penna igienizzante multifunzione antibatterica, con spray ricaricabile e puntatore touch. Capacità 3 ml. (liquido non incluso). | Antibacterial sprayer ballpen with rechargeable spray and pointer. 3 ml. capacity (liquid not included).

Abs | Abs

Ø 1,4 x 15,7 cm



Antibacterial



.02



20818
Richard



Penna a sfera antibatterica con meccanismo a scatto. | Antibacterial Push-up ballpoint pen.

Plastica antibatterica | Antibacterial plastic

13,8 cm



Antibacterial



.02



20292
Haiku



Penna a sfera antibatterica con gommino per touchscreen. Meccanismo a scatto. Finitura liscia, refill jumbo. | Antibacterial ball pen with push-up mechanism and grey colour pointer. Smooth finish, with jumbo cartridge.

Plastica | Plastic

Ø 1 x 13,9 cm



22196
Tartaru

Penna a sfera con meccanismo a torsione, in plastica con clip in metallo. Dotata di spray da 3ml (liquido non incluso). | Ballpoint pen with twist action mechanism, made of plastic with metal clip. Includes 3 ml spray. (Empty).

Plastica | Plastic

15,5 cm



ANTIBACTERIAL SPRAYER BALL PENS

With antibacterial treatments.



CLASSIC DESIGN HOOD PEN

Made in natural material.

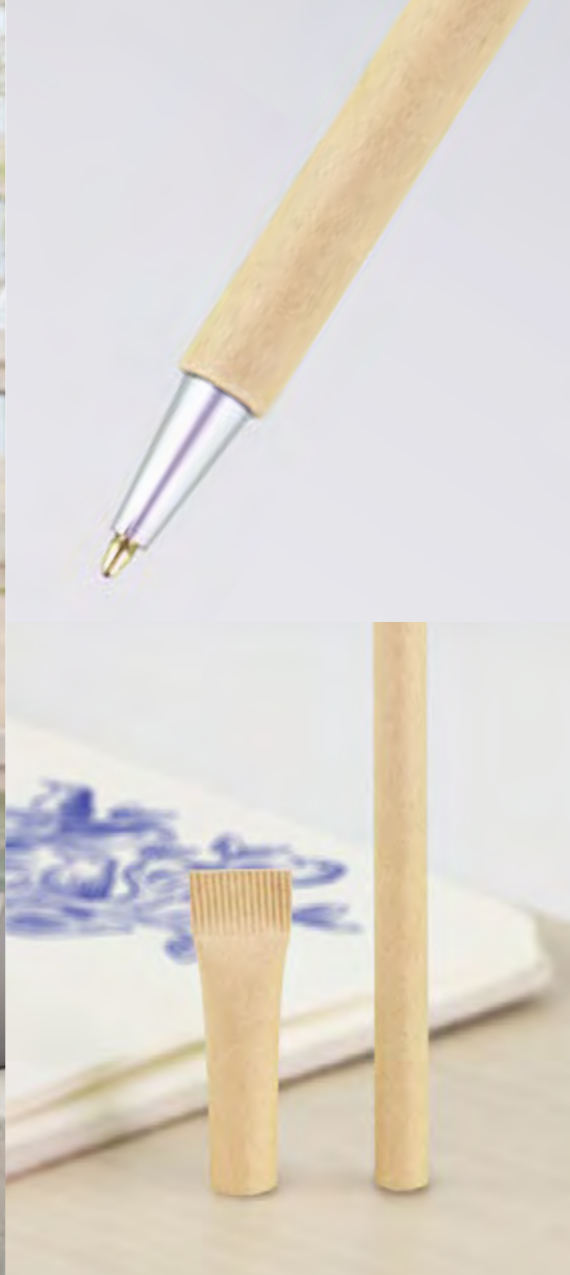

.08 .18 .04 .01 .24 .23 .07



20270 Tatone

Penna a sfera con meccanismo a torsione. Con gommino per touch screen e supporto per smartphone integrato. | Ballpen with twist action mechanism. With pointer for touch screen and built-in holder for smartphone.

Plastica | Plastic

14,7 cm



.05 .31 .03 .01 .16



22181 Protoattinio

Penna con finitura metallica, con gommino per touch screen e supporto per smartphone. | Pen with metallic finish, with pointer and space for placement and holding of our mobile devices.

Plastica | Plastic

14,5 cm



.05 .32 .07 .01



22182 Puran

Penna con finitura metallica, con gommino per touch screen e supporto per smartphone, che può essere utilizzato anche come pulisci schermo. | Ballpoint pen with metallic finish, with pointer and space for placement and holding of our mobile devices

Plastica | Plastic

15,5 cm



RECYCLED CARDBOARD



.02 .08 .00 .06 .05 .19

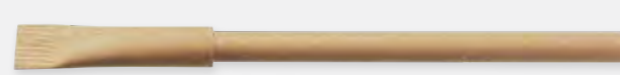

23017 Jerry

Penna a sfera con fusto e cappuccio in carta. | Ballpoint pen with body and cap made of paper.

Cartoncino | Cardboard

16 cm





.23 .08 .17 .04 .02



22135
Pomona

Penna a sfera con meccanismo a torsione, corpo e dettagli silver. Impugnatura morbida e gommino per touch screen. | Twist mechanism ball pen with silver coloured accessories. Soft grip and matching colour pointer

Plastica, Metallo | Plastic, Metal

13,5 x Ø 1 cm



.32 .04 .05 .08



22041
Evy

Penna a sfera con gommino per touch screen, design bicolore con dettagli silver e finitura del corpo metallica. Clip in metallo. Impugnatura morbida. | Twist mechanism ball pen with bright silver coloured accessories and a smooth body in metallic colours. With metal clip and matching colour ring.

Plastica, Metallo | Plastic, Metal

13,5 x Ø 1cm



.07 .08 .06 .19 .05 .24 .02 .01



.06 .07 .08 .16 .17 .24 .05 .18 .19 .04 .02 .01



.06 .07 .08 .17 .04 .19 .23 .01



.07 .08 .04 .05



20141
Ilta

Penna a sfera design bicolore con dettagli silver brillanti e corpo liscio con finitura in colore metallico. | Push-up ball pen in bicolour design with silver coloured detailing and a smooth body in striking bright metallic colours.

Plastica, Metallo | Plastic, Metal

13,8 cm



.08 .17 .24 .05 .19 .04 .01 .07 .06 .18 .02



20022
Elsi

Penna a sfera classica, meccanismo a scatto, design bicolore e corpo in diversi colori satinati con finitura liscia. Con confortevole grip coordinato. | Classic ball pen with push-up mechanism, bold bicolour design and body in frosted colours with a smooth finish. With comfortable, matching colour grip. Blue ink.

Plastica | Plastic

14,4 cm



20219
Manchester

Penna a sfera con meccanismo a scatto, con corpo bianco e clip colorata | Ballpen with push-up mechanism, with white body and coloured clip.

Plastica | Plastic

13,5 cm



20813
Asha

Penna a sfera con meccanismo a scatto, design monocoloro disponibile in diverse varianti lucide. | Push-up ball pen with monochrome design with a glossy finish.

Plastica | Plastic

13,8 x Ø 1 cm



20999
Assim

Penna a sfera con meccanismo a scatto. Fusto bianco e clip colorata. | Ballpoint pen with click action mechanism. White barrel with coloured clip.

Plastica | Plastic

13,8 x Ø 1 cm





20269
Ammolite

Penna a sfera con meccanismo a torsione. Fusto bianco, clip bianca dal design geometrico, con interno colorato. | Ballpen with twist action mechanism. White barrel, white clip in geometric design, with coloured inner detail.

Plastica | Plastic

14 cm



20338
Prezzemolo

Penna a sfera con meccanismo a torsione e finitura lucida bicolore. | Ballpoint pen with twist mechanism and two-tone glossy finish

Plastica | Plastic

14 cm



20267
Amman

Penna a sfera con meccanismo a torsione. Clip dal design geometrico, con interno nero. | Ballpen with twist action mechanism. Clip in geometric design, with black inner detail.

Plastica | Plastic

14 cm



BALLPENS WITH GEOMETRIC DESIGN

Made of plastic.





.08 .07 .06 .04



20334
Muffetto

Penna a sfera a scatto con corpo colorato e clip e impugnatura nera | Ball pen with push-up mechanism, with colored body and black grip.

Plastica | Plastic

14,2 cm



.08 .07 .02 .17 .19 .04 .06 .23



20196
Seaford

Penna a sfera, meccanismo a scatto, con fusto colorato e clip e impugnatura nera. | Ballpoint pen, click action mechanism, with coloured barrel and black grip and clip.

Plastica | Plastic

13,8 x 1,4 cm



.03 .04 .23 .08



20279
Rezzo

Penna a sfera con meccanismo a scatto. Fusto con finitura opaca. Clip e pulsante con finitura semitrasparente. | Ballpen with click action mechanism. Barrel with matt finish, button and clip translucent.

Plastica | Plastic

14 cm



.02 .08 .23 .01



23079
Derivatore

Penna a sfera con meccanismo a scatto, corpo colorato, clip bianca particolarmente adatta per la personalizzazione. | Ball Pen with push-up mechanism. Colored barrel, flat clip suitable for printing.

Plastica | Plastic

Ø 1,20 x 14,5 cm



.32



23012
Waterbury

Penna a sfera con calibro integrato. Meccanismo a scatto. | Ballpoint pen with plastic body, with design of a caliper. Push-up mechanism.

Plastica | Plastic

15 cm



.08 .01 .05



29030
Meda

Penna a sfera con meccanismo a scatto, impugnatura gommatata. Dotata di meccanismo a rotazione che rilascia foglietti memo. | Ballpen with click action mechanism, rubber grip. When twisted releases a sticky note memo.

Plastica | Plastic

14,5 cm

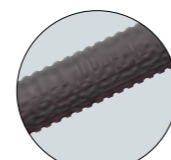

TYRE SHAPE



.23 .06 .02



20278
Sky

Penna a sfera con meccanismo a scatto, fusto con design pneumatico. | Ballpen with click action mechanism. Barrel with tyre shape.

Plastica | Plastic

14 x Ø 1,15 cm



.23 .04 .08



20030
Mika

Penna a sfera con corpo semitrasparente con dettagli cromati, meccanismo a scatto, con clip in metallo | Frost plastic ballpen, click action mechanism, coloured barrel with chrome fittings, black ink

Plastica | Plastic

13 cm



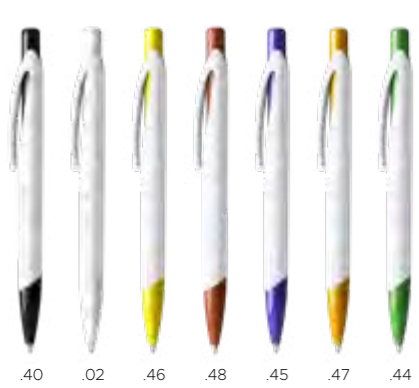

22191

Camponogara

NEW

Penna a sfera con meccanismo a scatto, puntale e pulsante colorati in tinta. | Ballpoint pen with click mechanism, tip and button colored in the same color.

Abs | Abs

14 x Ø 1,1 cm



20215

Bouse

Mini penna a sfera con meccanismo a torsione, corpo tinta unita. Originale clip oversize e anellino centrale silver. | Mini ball pen with twist mechanism in bold solid colours. With original oversized clip and silver coloured center ring.

Plastica | Plastic

9,6 x Ø 1 cm



.08



20212

Planet

Penna a sfera con clip con mondo girevole | Ballpoint pen with clip with revolving world

Plastica | Plastic

16,2 x Ø 1,2 cm



.23

.08

.04



20286

Bombae

Penna a sfera, effetto luce premendo il meccanismo a scatto, clip in metallo, incluse batterie | Light-up ballpen with push button, Batteries included

Plastica, Metallo | Plastic, Metal

14,7 cm



.21



20085

Taima

Stilofofo con 3 penne a sfera | Frosted pen holder with 3 pens, black, blue and red ink

Plastica | Plastic

12 x 10,5 x 11,5 cm



.08



29001

Lise

Set 2 penne a sfera con sticky notes | Two plastic ballpens and note pad stickers in holder with clip

Plastica | Plastic

15 x 2 x 1,8 cm



.08



20069

Maye

Penna a sfera, dal design rossetto. Con cappuccio. | Fun ballpen with plastic body, design of a lipstick. With removable hood.

Plastica | Plastic

10 x Ø 1,5 cm



.02



20006

Farma

Penna originale dal design che richiama un tubetto, corpo bianco. Con tappo a vite | Original ball pen with tube design and solid body in white. With screw-on hood and blue ink.

Plastica | Plastic

12 x Ø 1,8 cm



.08



20139

Simin

Penna a sfera mini con anello portachiavi | Mini ballpen with metal ring

Plastica | Plastic

10 x Ø 0,8 cm





.23 .08 .32



22126
Clearwater

NEW

Penna a sfera multi inchiostro, 3 colori di inchiostro, pulsanti retrattili, corpo in abs con dettagli neri. Impugnatura confortevole. Inchiostro blu, nero e rosso. | Multi ink ballpoint pen, 3 ink colors, retractable buttons, abs body with black details. Comfortable grip Blue, black and red ink.

Abs | Abs

14,8 x 1,3 cm



.02 .08 .04 .05



20180
Mahendra

Penna a sfera con refill in 2 colori. | Ballpoint pen with refill in two colours.

Plastica | Plastic

14 x 1,3 cm



.40 .45 .44 .48



20821
Pollino

NEW

Penna a sfera multi inchiostro, 4 colori di inchiostro con pulsanti retrattili. Corpo bianco con impugnatura morbida colorata. Colori inchiostro blu, nero, rosso e verde. | Multi-ink ballpoint pen, 4 ink colors with retractable buttons. White body with colored soft grip. Blue, black, red and green ink colors.

Abs | Abs

Ø 1,3 x 14,1 cm



.19 .08 .23 .03



23809
Abetone

Penna roller con corpo nero e dettagli colorati. Con cappuccio. | Roller pen made of plastic, black body with coloured details, detachable hood.

Plastica | Plastic

14 cm



22183
Radhuni

Penna roller con clip metallica e punta in acciaio. Corpo colorato con finitura gommata. Refill jumbo. | Rollerball pen with metal clip and steel tip. Colorful, soft touch body with rubber finish. Jumbo refill.

Abs | Abs

14 cm



.05 .03 .32



20327
Debby

Penna roller, con corpo in plastica con finitura metallizzata, cappuccio removibile. | Roller pen with plastic body with metallic finish, removable hood.

Plastica | Plastic

13 cm

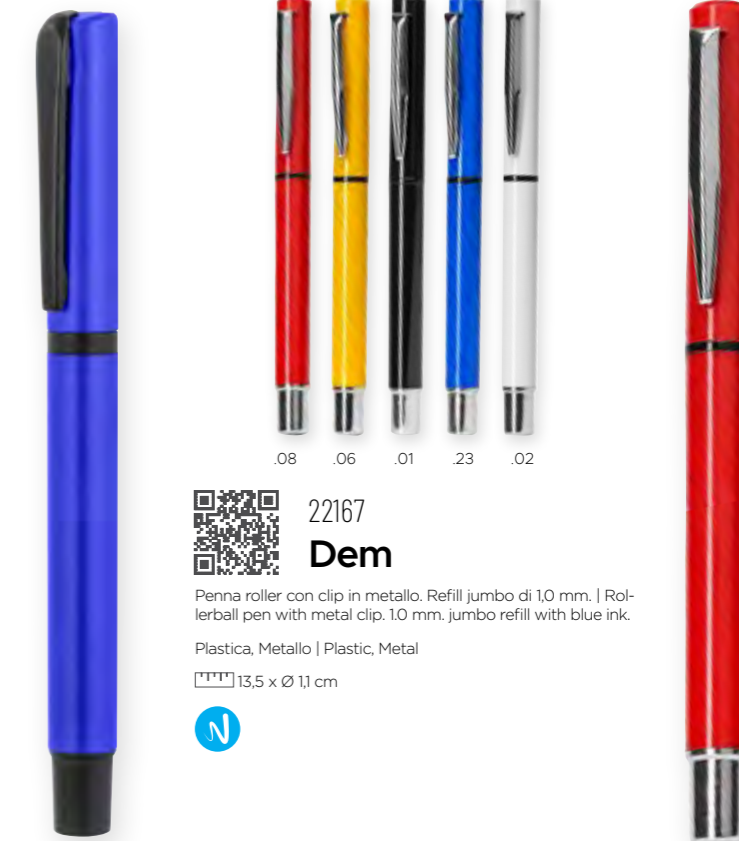

22167
Dem

Penna roller con clip in metallo. Refill jumbo di 1,0 mm. | Rollerball pen with metal clip. 1.0 mm. jumbo refill with blue ink.

Plastica, Metallo | Plastic, Metal

13,5 x Ø 1,1 cm





.01 .02 .32 .04 .23 .07 .08



22198
Vela

Penna a sfera con gommino per touch screen. Meccanismo a torsione. | Ballpoint pen with pointer for screens. Twist action mechanism.

Alluminio | Aluminum

14,5 cm



.08 .02 .01 .23 .04 .18 .32 .06 .07 .17



22058
Grumichama

Penna a sfera con meccanismo a scatto. Finitura in alluminio brillante, refill jumbo. | Ball pen with push-up mechanism in cheerful colours. Shiny aluminium finish. Jumbo refill

Alluminio | Aluminum

14,5 cm

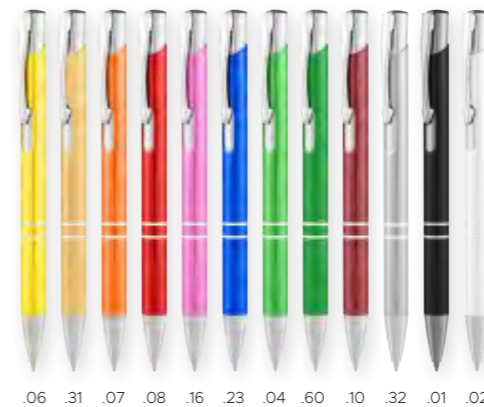

.06 .31 .07 .08 .16 .23 .04 .60 .10 .32 .01 .02



22049
Guus

Penna a sfera con meccanismo a scatto, design elegante. Clip, anellini e puntale silver. | Push-up mechanism ball pen in an elegant bicolour design. With die-cut aluminium body in smooth aluminium. Original clip, rings and tip in silver.

Alluminio | Aluminum

13,5 cm



.06 .02 .01 .04 .08 .23



22176
Alite

Penna a sfera con meccanismo a scatto, con finitura gommatata. Con gommino per touch screen. | Ballpen with push-up mechanism, made of aluminium with rubber finish. With pointer for touch screen.

Alluminio | Aluminum

14,5 cm



.06 .05 .02 .10 .24 .01 .08 .04



22282
Saludecio

Penna a sfera con corpo in alluminio con finitura gommatata. Meccanismo a scatto. | Ballpoint pen with body made of aluminium with rubber finish. Push-up mechanism, coloured barrel with a soft-touch finish.

Alluminio | Aluminum

14 cm



.08 .23 .04



22900
Ikaalinen

Penna a sfera, con finitura speciale per incisione laser, con meccanismo a scatto. Colore dell'incisione coordinato con il colore del pulsante. | Ball pen with special finish for laser marking. The upper part of the ballpoint pen matches the colour after engraving.

Metallo | Metal

14 cm



ELEGANT BICOLOUR DESIGN

Ballpoint pens made of aluminium with rubber or glossy finish.





20339
Promezio

Penna a sfera metallica con meccanismo a scatto. Con gommino per touchscreen e clip di design. Refill jumbo. | Metal ballpoint pen with snap mechanism. With touchscreen nib and designer clip. Jumbo refill

Metallo | Metal
Ø1 x 14,8 cm



.06 .08 .23 .01 .04 .02

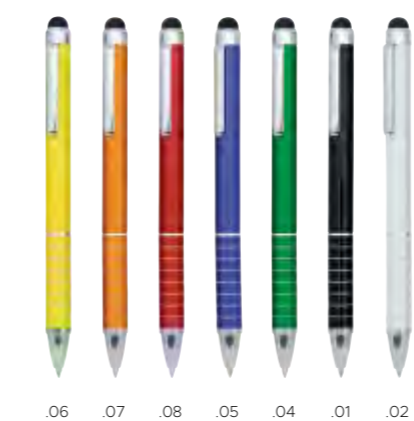

.06 .07 .08 .05 .04 .01 .02



22005
Aponi

Penna a sfera con meccanismo a torsione, corpo in alluminio. Dettagli e anellini silver. | Pointer ball pen with twist mechanism and aluminium body in smooth metallic finish. Details and rings in silver colour.

Alluminio | Aluminum
12 cm

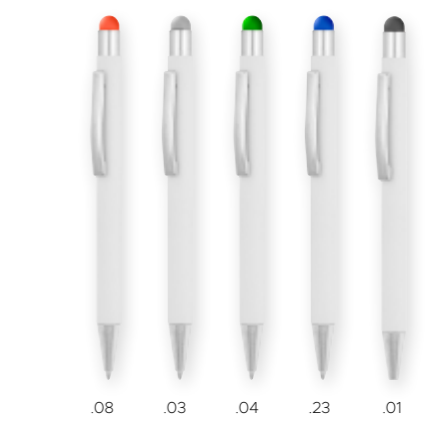

.08 .03 .04 .23 .01



96999
Aasiaat

Penna a sfera con meccanismo a scatto. Gommino per touch screen coordinato con il sottostrato del corpo della penna. | Pointer ball pen with push-up mechanism. Pointer in matching colour with the inner tone and with chromed details.

Alluminio | Aluminum
14,2 cm



.32 .05 .08 .17 .04



20336
Potassio

Penna a sfera con corpo colorato, impugnatura in gomma nera, meccanismo a scatto, pulsante e clip silver. | Ballpoint pen with colored body, black rubber grip, snap mechanism, silver button and clip.

Alluminio | Aluminum
14 cm



.32



22999
Imatra

Penna a sfera con gommino per touch screen, meccanismo a torsione. Clip cromata. | Pointer ball pen with twist mechanism and aluminium body in smooth metallic finish. Chrome clip.

Alluminio | Aluminum
12,9 cm



22980
Juva

Penna a sfera con gommino per touch screen, meccanismo a torsione, corpo nero solido. Particolarmente adatta all'incisione laser. | Pointer ball pen with twist mechanism, body in black solid colour. Especially designed for laser engraving

Alluminio | Aluminum
14,2 cm



.19 .32 .08 .23



.01 .02 .32 .07 .08 .17 .05 .04 .06



22911
Lilibit

Penna a sfera con gommino per touch screen e corpo ultra sottile. | Pointer ball pen with twist mechanism and ultra-fine body.

Alluminio | Aluminum

14 x 1,1cm



.01 .07 .08 .05 .19 .02 .06



22153
Garlenda

Penna a sfera con meccanismo a torsione. Con gommino per touch screen. | Ballpen with twist action mechanism. With pointer with touchscreen.

Alluminio | Aluminum

14 x Ø 1 cm



.01 .32 .04 .08



22014
Muna

Penna a sfera con meccanismo a scatto. Fusto in metallo colorato, impugnatura in gomma. | Metal ballpen with rubber grip, blue ink

Alluminio | Aluminum

13,8 x Ø 1cm



.32 .03



22151
Berlino

Penna a sfera con meccanismo a scatto. Fusto in alluminio con anellini sul grip. | Ballpen with click action mechanism. Aluminium barrel with ringed grip.

Alluminio | Aluminum

14,1 Ø 1 cm



.02 .05 .08 .23 .04 .01



23065
Cevedale

Penna a sfera con meccanismo a scatto. Particolarmente adatta all'incisione laser. | Ballpoint pen with click mechanism. Particularly suitable for laser engraving.

Metallo | Metal

13,7 x Ø 1 cm



SPECIAL FOR
LASER ENGRAVING



.08 .23



22012
Koa

Penna a sfera con cappuccio, con anello colorato. | Ballpen with cap, with colored ring.

Acciaio | Steel

14,3 cm

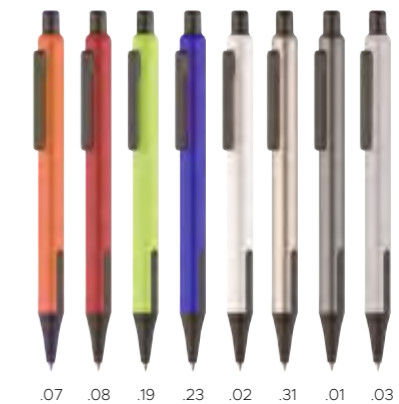

.07 .08 .19 .23 .02 .31 .01 .03



23067
Chiavenna

Penna a sfera con meccanismo a scatto, finitura laccata colorata. Clip, pulsante e puntale nero. | Ballpoint pen with lacquered finishing

Alluminio | Aluminum

14 cm



ELEGANT BALL PENS

Made of aluminium.



20324
Portus

Penna a sfera con meccanismo a scatto, corpo in alluminio con finitura opaca, e clip, puntale e pulsante con finitura oro rosa opaca. | Ballpen with aluminium body with a matt finishing and clip, tip and button in matt pink golden colour.

Alluminio | Aluminum

13,5 cm



20323
Chuka

Penna a sfera con meccanismo a torsione, design bicolore. Finitura laccata. | Ballpen with twist action mechanism, bicolour design, with lacquered body.

Alluminio | Aluminum

14 cm



.02 .01 .16



.32 .16 .31



22197
Tattoo

Penna a sfera in metallo, con meccanismo a torsione, e pietra luccicante nella parte alta. | Ballpoint pen made of metal with twist action mechanism and stone on top.

Metallo | Metal

13 cm





PARKER

EST. 1888



PK1009
Calto

Set composto dalla classica penna a sfera Parker Jotter in acciaio inox e dal porta mine in acciaio inox, disposte all'interno di una elegante confezione Parker. | Set consisting in the classic Parker Jotter stainless steel ballpoint pen and the stainless steel mechanical pencil, packed in an elegant Parker box

Acciaio Inossidabile | Stainless steel

12,9 x Ø 1 cm



NEW



Parker Urban
BALLPOINT PEN



.01 .32



PK1004
Caerano

Penna a sfera Parker Urban realizzata in ottone laccato con finiture cromate a contrasto. Movimento a scatto. Fornito nella scatola originale Parker. | Parker Urban ballpoint pen made of lacquered brass with contrasting chrome finishes. Snap motion. Supplied in the original Parker box.

Metallo | Metal

14 x Ø1,2 cm



NEW



Parker Vector XL
ROLLERBALL PEN



.01 .32



PK1005
Calalzo

Semplice, essenziale e affidabile: Vector si distingue per la sua qualità e adattabilità. Articolo fornito con un refill a sfera. | Simple, essential and reliable: Vector stands out for its quality and adaptability. Item comes with a ballpoint refill.

Plastica, Metallo | Plastic, Metal

12,5 x Ø 1 cm



NEW



Parker IM
ROLLERBALL PEN



.01 .23



PK1000
Buttapietra

Penna roller Parker IM realizzata in ottone cromato con finiture lucide a contrasto. Fornito nella scatola originale Parker. | Parker IM roller pen made of chromed brass with contrasting glossy finishes. Supplied in the original Parker box.

Metallo | Metal

13,6 x Ø1,1 cm



NEW



Parker IM
ROLLERBALL PEN



.01 .32



PK1002
Cadore

Penna roller Parker IM realizzata in ottone nobile e ricoperta di vernice metallizzata con finiture cromate a contrasto. Fornito nella scatola originale Parker. | Parker IM roller pen made of noble brass and covered with metallic paint with contrasting chrome finishes. Supplied in the original Parker box.

Metallo | Metal

13,6 x Ø1,1 cm



NEW



Parker IM
ROLLERBALL PEN



.01 .23



PK1001
Cadoneghe

Penna roller Parker IM realizzata in ottone cromato con finiture lucide a contrasto. Movimento a scatto. Fornito nella scatola originale Parker. | Parker IM roller pen made of chromed brass with contrasting glossy finishes. Snap motion. Supplied in the original Parker box.

Metallo | Metal

13,6 x Ø1,1 cm



NEW



Parker IM
ROLLERBALL PEN



.01 .32



PK1003
Domegge

Penna a sfera Parker IM. Fornito nella scatola originale Parker. | Parker IM ballpoint pen made of noble brass and covered with metallic paint with contrasting chrome finishes. Snap motion. Supplied in the original Parker box.

Metallo | Metal

13,6 x Ø1,1 cm



NEW





.32

Parker Jotter
BALLPOINT PEN



Stainless Steel



PK1006
Caldiero

NEW

Penna a sfera Parker Jotter realizzata in acciaio inossidabile con finiture cromate a contrasto. Movimento a scatto. Fornito nella scatola originale Parker. | Parker Jotter ballpoint pen made of stainless steel with contrasting chrome finishes. Snap motion. Supplied in the original Parker box.

Acciaio Inossidabile | Stainless steel

12,9 x Ø 1 cm



.32

Parker Jotter
MECHANICAL PEN



Stainless Steel



PK1007
Caldogno

NEW

Portamine Parker Jotter (punta 0,5 mm). Gomma per cancellare integrata sotto il tappo a pressione. Fornito nella scatola originale Parker. | Parker Jotter pencil made of stainless steel with contrasting chrome finishes. Item supplied with replacement pencil leads (0,5 mm tip). Eraser integrated under the pressure cap. Supplied in the original Parker box.

Acciaio Inossidabile | Stainless steel

12,9 x Ø 1 cm



.01 .08 .07 .24 .05 .18

Parker Jotter
BALLPOINT PEN



Stainless Steel



PK1008
Callalta

NEW

Penna a sfera Parker Jotter realizzata in acciaio inossidabile con finiture cromate a contrasto. Movimento a scatto. Fornito nella scatola originale Parker. | Parker Jotter ballpoint pen made of stainless steel with contrasting chrome finishes. Snap motion. Supplied in the original Parker box.

Acciaio Inossidabile | Stainless steel

12,9 x Ø 0,97 cm



.07 .04 .17 .06 .23 .02 .05 .08 .01

Parker Jotter
BALLPOINT PEN



PK1010
Caltrano

NEW

Penna a sfera Parker Jotter. (Box acquistabile separatamente PK1012) | Parker Jotter ballpoint pen made of high quality plastic and delicately brushed steel, contrasting finishes with polished steel. Snap motion. (Box can be purchased separately PK1012)

Plastica, Acciaio inossidabile | Plastic, Stainless steel

12,9 x Ø 0,8 cm



COMPLETE YOUR
JOTTER WITH
THE GIFT BOX



PK1011
Calavena

NEW

Scatola Parker classica adatta a contenere diversi modelli di penna | Classic Parker box suitable for holding different pen models

Cartoncino | Cardboard

18x3,5x5,5cm



PK1012
Calvene

NEW

Scatola Parker colorata per penna jotter | Parker Colored Jotter Pen Box

Cartoncino | Cardboard





26500
Maflu

Matita evidenziatore in legno, scrittura morbida, finitura del corpo lucida. | Wooden pencil marker with soft writing in fun colors, with a glossy body finish.

Legno | Wood

17,5 x Ø 0,7 cm



29251
Galliate

Evidenziatore semplice, corpo e cappuccio traslucenti | Fluorescent marker, with body and hood in translucent finish.

Plastica | Plastic

2,3 x 6 x 1,4 cm



29007
Noor

Evidenziatore 5 colori | Highlighter with five colours

Plastica | Plastic

10 x 2 cm



29173
Diversivo

Set 3 evidenziatori in astuccio con supporto telefono e pulisci schermo. | 3 gel highlighter set in case with screen cleaner and mobile phone holder.

Plastica | Plastic

11 x 1,8 x 5,2 cm

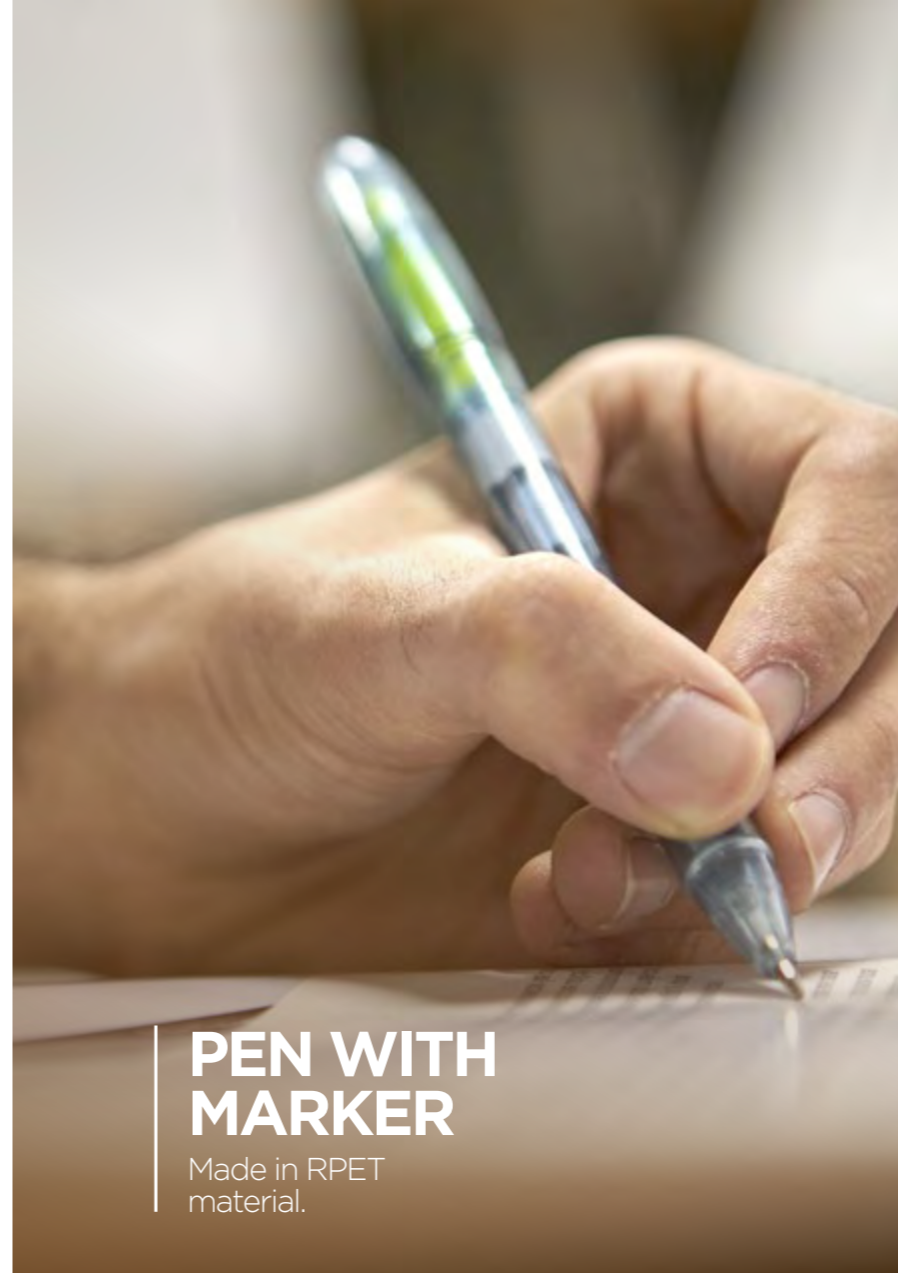

PEN WITH MARKER

Made in RPET material.



RECYCLED PLASTIC



29277
Diletta

Penna con evidenziatore. Corpo trasparente, refill blu e evidenziatore disponibile in tre colori. | Pen/marker with blue transparent body and marker available in three fluor colours.

Plastica RPET | RPET plastic

14,6 x Ø 1,3 cm





.00



20176
Lis



Set penna a sfera con meccanismo a scatto e portamine. Fornito in confezione di cartoncino finitura lucida, fustellata, effetto legno. | Set of push-up mechanism ball pen and mechanical pencil in an original combination of natural bamboo wood and metallic finish accessories in shiny silver colour. Presented in a single, glossy cardboard die-cut case in wooden finishing.

Bamboo | bamboo

13,8 x Ø 1 cm



.11



22071
Lurdessy



Penna a sfera con meccanismo a torsione. Fusto e clip in metallo. | Ballpen with twist action mechanism. Bamboo barrel with metal clip.

Bamboo | bamboo

15,5 x 4 cm



.32



22169
Didi



Penna in metallo con finitura cromata ed impugnatura in sughero. Confezionata in un astuccio di sughero. Refill jumbo. | Metal ball pen in chrome plated finish and cork grip. Presentation in a cork case. Metal jumbo refill.

Pen: Sughero, metallo; Box: Cartone, Sughero | Pen: Cork, metal; Box: Cardboard, Cork

13,9x Ø 1,1 cm



.11



22048
Consolzis



Penna a sfera con meccanismo a torsione, con dettagli in acciaio, fornita in scatola regalo in bambù con chiusura magnetica. | Ballpoint pen with twist mechanism, with steel details, supplied in a bamboo gift box with magnetic closure.

Acciaio Inossidabile, Bamboo | Stainless Steel, Bamboo

17 x 4 x 2,5 cm



.11

NATURAL CORK



22187
Campiglia



Set scrittura composto da penna a sfera e penna roller, corpo in metallo e sughero. Penna a sfera con inchiostro blu, penna roller con cappuccio e inchiostro nero. | Writing set consisting of ballpoint pen and rollerball pen, metal body and cork. Ballpoint pen with blue ink, rollerball pen with cap and black ink.

Sughero, Metallo | Cork, Metal

17,3 x 6,4 x 2,9 cm



.01

NATURAL CORK



22189
Fonte



Penna roller fornita in elegante scatola regalo nera con dettagli in sughero e imbottitura interna. | Rollerball pen supplied in an elegant black gift box with cork details and internal padding.

Sughero, Acciaio | Cork, Steel

13,8 x Ø 1,0 cm





22188
Camisano

NEW

Elegante set composto da roller e portamine. Meccanismo a rotazione. Design cromato scuro. Presentazione in custodia in similpelle con fodera interna. | Elegant set consisting of roller and mechanical pencil. Rotating mechanism. Dark chrome design. Presented in a leatherette case with inner lining.

Metallo, Pelle | Metal, Leather

13,6 x Ø 1,1 cm



22801
Bena

Set composto portamina e penna a sfera con meccanismo a scatto. Fornite in astuccio | Set composed by mechanical pencil and ballpen with click action mechanism. Presented in a plastic case.

Metallo | Metal

4,9 x 2,6 x 16 cm



22885
Hind

Elegante parure composta da penna a sfera con meccanismo a torsione e penna roller cappuccio. Dettagli cromati. Fornita in astuccio nero con interno sagomato. | Elegant set consisting of ballpoint pen with twist mechanism and rollerball pen cap. Chrome details. Supplied in black case with shaped interior.

Metallo | Metal

17,5 x 5,5 x 2,5 cm



IMITATION SUEDE



29169
Manghetti

NEW

Custodia per penna | Ball pen sleeve in soft, brightly coloured velvet.

Floccato | Flocked

2,5 x 15 cm



STRONG CARDBOARD



29309
Canaro

NEW

Custodia per penna con finestra | Pen case with window

Cartoncino | Cardboard

4 x 15,5 cm



29067
Randy

Astuccio per penna | Pen holder

Metallo | Metal

18 x 6 cm



29166
Madan

Astuccio per una penna. | Individual cardboard case for one pen.

Cartoncino | Cardboard

18 x 2 x 4 cm



29167
Said

Astuccio per penna con interno in velluto. | Cardboard penholder with velvet inside.

Cartone, Vellutino | Cardboard, Velor

17,5 x 5,5 x 2,5 cm

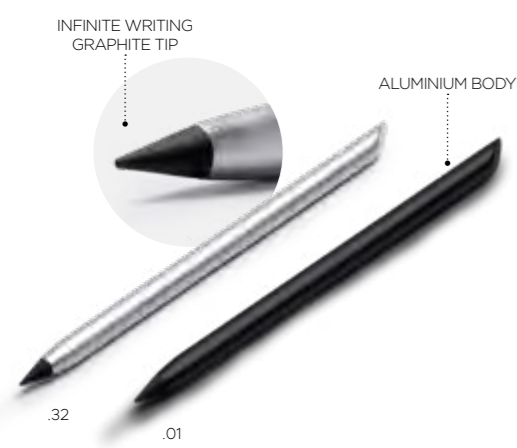

.32
.01



22204
Villanova

NEW

Matita con mina per scrittura intercambiabile infinita. Senza bisogno di temperare. | Pencil with infinitely interchangeable writing lead. No need to temper.

Alluminio | Aluminum

15 x 0,8 cm



.00



22205
Donà

NEW

Matita perpetua con corpo in bambù. Gomma inclusa. | Perpetual pencil with bamboo body. Rubber included.

Bamboo | bamboo

15 x Ø 0,8 cm



WHEAT FIBER
RECYCLED CARDBOARD

.00



22203
Valdastico

NEW ECO

Matita perpetua con mina per una scrittura infinita. Senza bisogno di temperare. | Perpetual pencil with lead for infinite writing. No need to temper.

Cartoncino, fibra di grano | Cardstock, Wheat Fiber

14 x 0,8 cm



.00



22192
Campo

NEW

Matita perpetua. Punta in grafite, non necessita di essere temperata | Perpetual pencil. Graphite tip, does not need to be tempered

Bamboo | bamboo

Ø 0,8 x 15 cm



.00



22185
Nessy



Matita in grafite, dettagli cromati. La durata della mina equivale alla durata di 100 matite HB | Graphite pencil, chrome details. The life of the lead is equivalent to the life of 100 HB pencils.

Bamboo, metallo | Bamboo, metal

13,5 x Ø 1 cm



.00



22186
Neyman



Matita in grafite con gomma per cancellare, fornita in confezione regalo in cartoncino avana. La durata della mina equivale alla durata di 100 matite HB | Graphite pencil with eraser, supplied in a brown cardboard gift box. The life of the lead is equivalent to the life of 100 HB pencils.

Bamboo, metallo | Bamboo, metal

Pencil: Ø 1 x 16 cm - Box: 5,8 x 18,5 cm



LONG LIFE PENCILS

1pc is almost equal to 100pcs normal pencil.

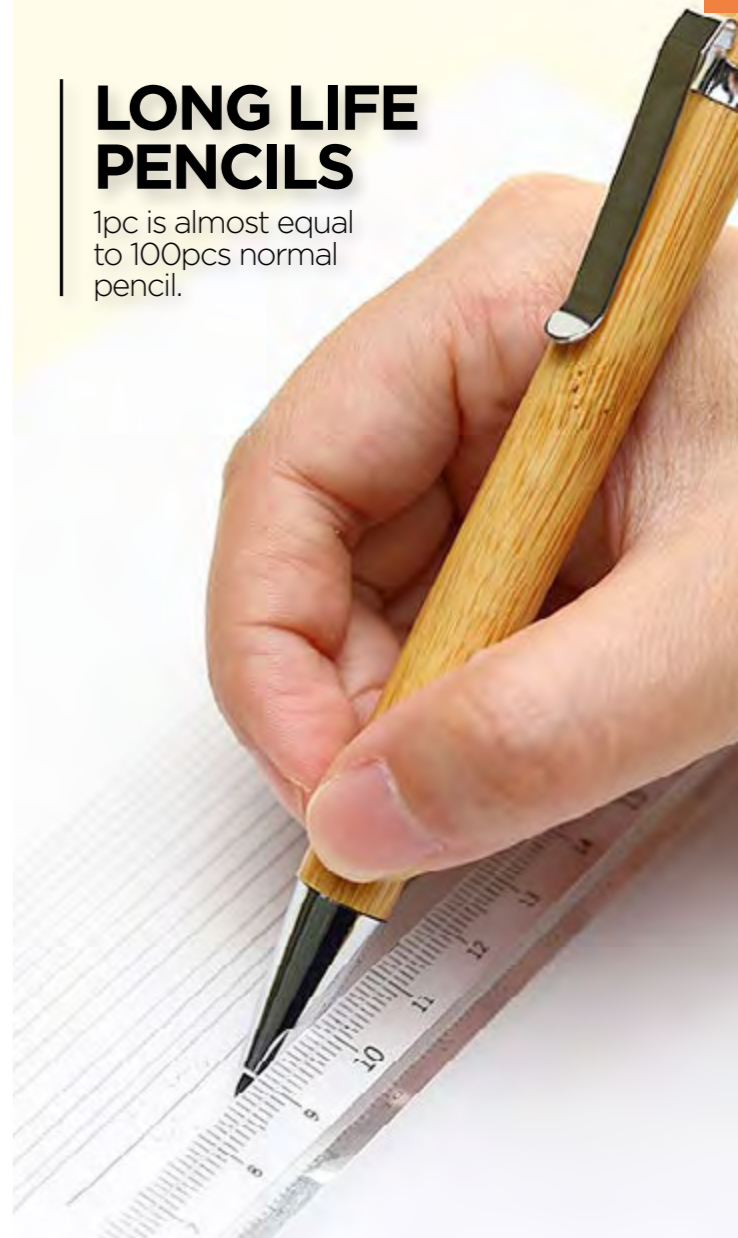

ANTIBACTERIAL PENCIL

Pencil with antibacterial finish with rubber on top.



SET OF 6 PENCILS



96195
Barbegara

Set con 6 matite in legno bianco, fornite in confezione singola bianca | Set of 6 pencils in white colour presented in a with box.

Legno | Wood

18,5 x 5 x 19 cm



.01 .02 .08 .32 .17 .18



96046
Stein

Matita con gomma. Mina nera | Pencil with rubber. With black lead.

Legno | Wood

18,5 cm



.32



96127
Zama

Elegante matita in legno nero con corpo in colore silver o oro. | Elegant black wooden pencil with body in elegant silver and golden colours.

Legno | Wood

17,7 x 0,7 cm



.01 .05 .17 .18 .19



96133
Clivia

Matita con gomma colorata coordinata. | Pencil with matching colour eraser.

Legno | Wood

0,7 x 19,1 cm



.00



96154
Treme

Matita in legno con finitura antibatterica, con gommino. | Pencil with antibacterial finish with rubber on top.

Legno con finitura antibatterica | Wood with antibacterial finish

18,6 x 0,7 cm



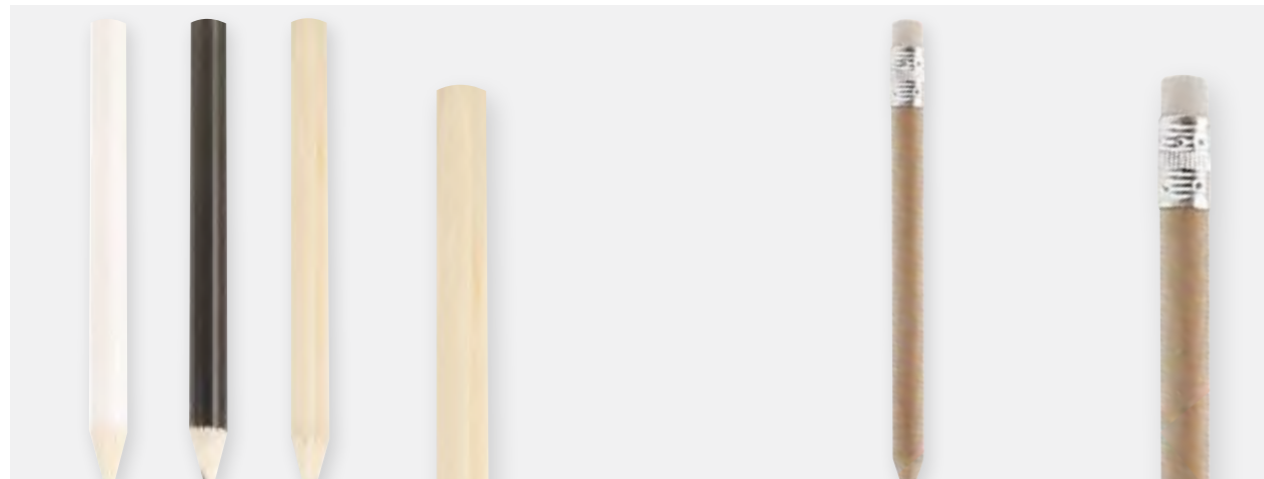

.02 .01 .00

.00



96099
Hipo

Mini matita temperata | Sharpened small pencil

Legno | Wood

Ø 0,7 x 9 cm



96100
Tiril

Mini matita in legno con gomma | Wooden mini pencil with eraser.

Legno | Wood

Ø 0,5 x 9 cm



.06



96032
Frida

Matita. Non temperata | unsharpened pencil

Legno | Wood

Ø 0,7 x 19 cm



.05

.02

.16



23075
huittinenù

Matita in legno nero con anellino integrato con pompom. | Black colour wooden pencil with hanging pompon.

Legno, poliestere | Wood, polyester

17,5 cm



.00



96892
Isera

Matita. Spessore 1 cm. | Pencil with a thickness of 1cm.

Legno | Wood

Ø 1 x 17 cm



WOOD PENCILS

With eraser.



96052
Svein

Matita con gomma. | Pencil with eraser.

Legno | Wood

Ø 0,7 x 19,1 cm

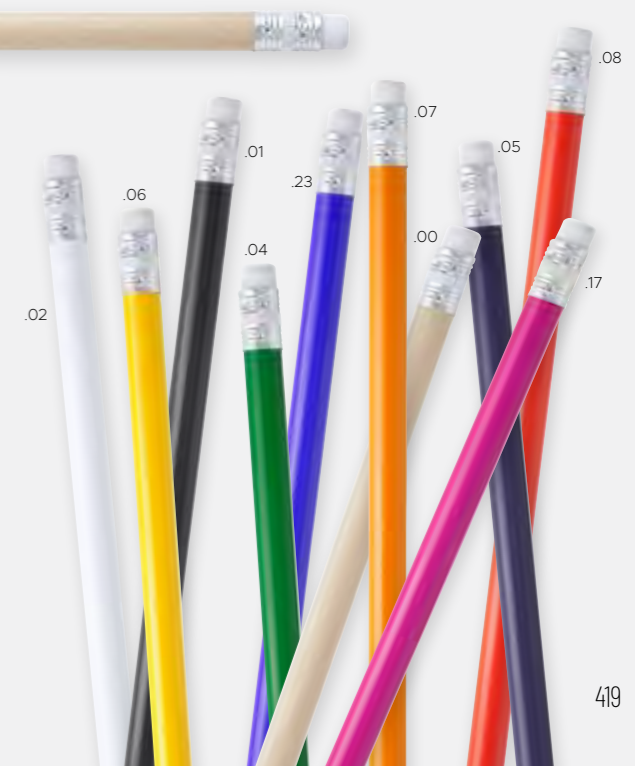



Sprouts

IT'S JUST A SMALL PENCIL BUT ITS DREAM IS TO BECOME A TREE!



96144BOX
Box

Cartoncino per matite Sprout Sprout personalizzato 96144 (matita esclusa) | Customized Box for Sprout Spout pencil 96144 (Spout pencil not incl.)

Cartone | Cardboard

20 x 5 cm

THE ORIGINAL ONE



96144
Gantz

Matita Sprout con semi a scelta | Sprout pencil with seeds of your choice

Legno | Wood

19 cm



Sprouts



THE VARIETIES

- (.00) Girasole - Sunflower
- (.01) Basilico - Basil
- (.03) Pomodorino - Cherry tomato
- (.04) Coriandolo - Coriander
- (.06) Nontiscordardime - Forget-me-not
- (.11) Salvia - Sage
- (.12) Timo - Thyme
- (.23) Margherita - Daisy
- (.27) Garofano - Carnation
- (.29) Chia - Chia



THE ORIGINAL ONE



.04



96156
Tree

E' solo una piccola matita ma il suo sogno è diventare un albero! Nuova Matita Sprout con semi di ABETE rosso. Vedi anche Art. 96144 | It's just a small Spout pencil but its dream is to become a tree! New Spout pencil with fir seeds.

Legno | Wood

19 cm



PLANT A TREE EDITION

Business and Office

Porta biglietti da visita, cartelle portadocumenti, set da ufficio, portablocchi con calcolatrice. Cartelle multi-tasca per ufficio e supporti per tablet. Portablocchi, quaderni, gomme, righelli e porta CD.

Business cards holders, docs folders, office sets, notepads holders with calculator. Multi-pocket office folders and tablet supports. Diaries, notebooks, rubbers, rulers and CD holders.

Business

and Office





.21



41026
Blan

Portacarta di credito per una carta | Credit card holder for one card

Plastica | Plastic

6 x 9 x 0,4 cm



.32



41359
Entella

Porta carte di credito RFID | Card holder with RFID protection

Alluminio | Aluminum

6 x 1 x 9,5 cm



.08 .02 .01



.05



41354
Agri

Elegante porta carte di credito. 6 scomparti interni, sistema di chiusura e area piatta esterna. Fornito in scatola singola. | Elegant card holder. With 6 inside compartments, buckle closure system and plain area on the outside. Presented in an individual box.

Alluminio | Aluminum

7,5 x 2 x 11 cm



.10 .01



.05



41131
Jorasses

Porta carte di credito, con 7 scomparti, uno di essi con tecnologia di sicurezza RFID. | Card holder made of leatherette with 7 pockets for cards, one of them with RFID.

Similpelle | Leatherette

11 x 8 cm

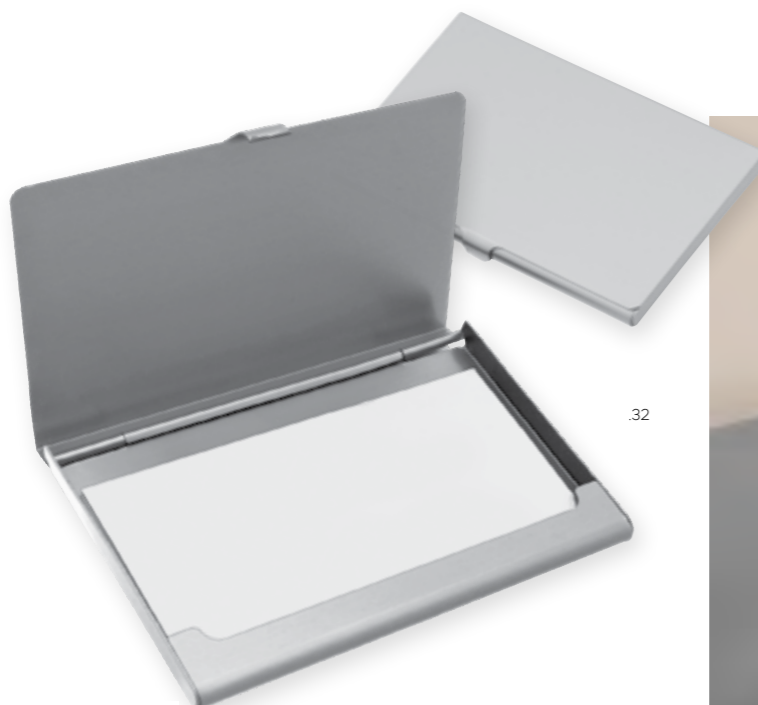

.32



40003
Anze

Elegante porta biglietti da visita. Chiusura a pressione. Fornito in confezione singola | Elegant card holder. With snap closure system and presented in an elegant black individual box.

Alluminio | Aluminum

9,3 x 5,9 x 0,5 cm



RECYCLED LEATHER



.01 .12



41142
Polverara



Porta carte di credito con tre tasche per carte. | Credit card holder with three card pockets.

Pelle riciclata | Recycled leather

10,5 x 8 cm



PORTFOLIO A4 SIZE

With magnetic closure.



**A4
SIZE**



62032
Pivi

Portfolio con chiusura zip. Diverse tasche interne. Include blocco a righe | Portfolio with zipper closure. Several inner pockets. Includes lined notepad

Nylon 600D | 600D nylon

25 x 34,5 cm



**A4
SIZE**

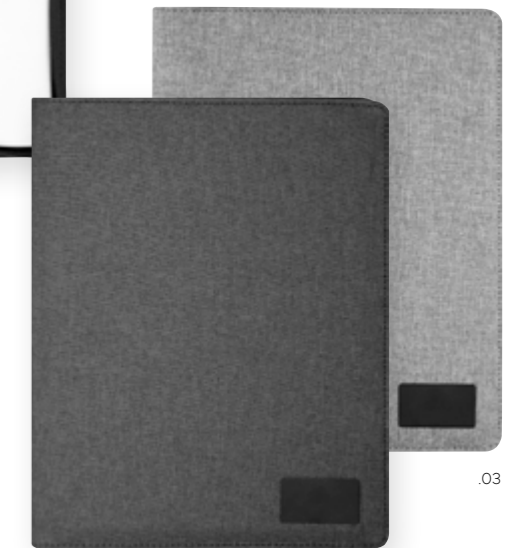

62062
Barron

Portfolio A4 con chiusura con zip. Diverse tasche interne. Comprende notebook da 20 fogli. Inserto in PU sulla copertina. | Portfolio in A4 size made of polyester with a zipper closing. It includes several inner pockets and a notebook with 20 sheets. Pu detail on cover.

Poliestere, Similpelle | Polyester, Leatherette

23,5 x 31 x 2 cm



**A4
SIZE**



62989
Kuta

Portfolio A4 con chiusura magnetica. Diverse tasche interne. Anellino portapenna. Comprende notebook da 20 fogli bianchi. Fascetta di chiusura con inserto in PU. | Portfolio A4 size made of polyester with magnetic closure. It has several inner pockets and notebook with 20 sheets. Closure strap with PU detail.

Poliestere, Similpelle | Polyester, Leatherette

23,5 x 2 x 31 cm



A4
SIZE



62004
Miko

Portablocco con chiusura elastica. Interno colorato coordinato con blocco da 20 fogli bianchi, tasca interna, porta biglietti da visita e porta penna. | Folder in microfibre with elastic band closure. Matching colour inside with notepad of 20 blank sheets, flap pocket, card holders and pen holder.

Microfibra, Poliestere | Microfibre, Polyester

25 x 31,5 x 1,5 cm



A4
SIZE

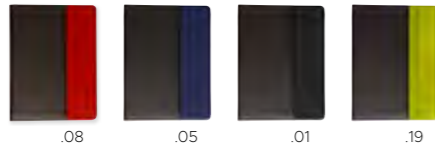

62990
Smycka

Portfolio con blocco fogli a righe e calendario, portapenna, tasca interna con diversi scomparti. | Portfolio with striped notebook and calendar on every page. Pen loop and pockets for cards and documents.

Similpelle | Leatherette

31 x 24 x 1 cm



A5
SIZE



62087
Dylan

Portfolio A5, con chiusura magnetica. Diverse tasche interne. Contiene blocco da 40 fogli senza righe color crema. | Portfolio and notebook size A5 made of PU outside and with a velvet finish inside with a magnetic closing. Several inner pockets and a notebook with 40 blank cream sheets.

Similpelle | Leatherette

17,5 x 21,5 x 1,5 cm



A4
SIZE



.03



62090
Kamo

Portablocco A4 con zip, block notes 20 pag. e calcolatrice 8 cifre dual power (penna esclusa) | A4 document folder with zip and 20 pages notepad and 8 digit dual power calculator

Similpelle | Leatherette

25 x 34 x 2 cm



ELEGANT CONFERENCE FOLDERS

A4 document folder
with zip and 20
pages.





DOCUMENT HOLDERS

With A4 & A5 notebook.



62985
Sockerkaka

Porta documenti con blocco con fogli a righe e calendario, portapenna, tasca interna con diversi scomparti. Chiusura con fascetta di gomma. | Documents holder with striped notebook and calendar on every page. Pen holder and pockets for cards and documents. Closure with rubber strap.

Poliestere | Polyester

31 x 23,5 x 1 cm



40281
Songesand

Portafoglio con diverse tasche porta carte di credito e porta biglietti da visita. Include blocco a righe. | Portfolio with inside pockets for business cards and credit cards. Include striped notebook.

Poliestere | Polyester

22,5 x 16,5 x 2 cm



62063
Gerolamo

Portafoglio A5, con chiusura magnetica. Diverse tasche interne. Comprende notebook da 20 fogli. Fascetta di chiusura in PU. | Portfolio in A5 size made of polyester with a magnetic closing. It includes several inner pockets and also a notebook with 20 sheets. Closure strap in PU.

Poliestere, Similpelle | Polyester, Leatherette

17 x 22 cm



62088
Bergantino

Portafoglio A4 con diverse tasche interne, include blocco con 20 fogli a righe. Chiusura magnetica. | A4 portfolio with several inner pockets, includes 20 lined sheets notepad. Magnetic closure.

Tessuto, Similpelle | Fabric, Leatherette

31 x 23,5 x 1 cm



62079
Brugo

Portadocumenti con un blocco interno di 2 fogli a righe in carta riciclata, chiusura magnetica. Diversi scomparti interni. | Portfolio with an inner notebook of 2 lined recycled sheets, magnetic closure, several inner compartments.

RPET 300D 48%, Nylon | RPET 300D 48%, Nylon

31 x 23 x 1,3 cm

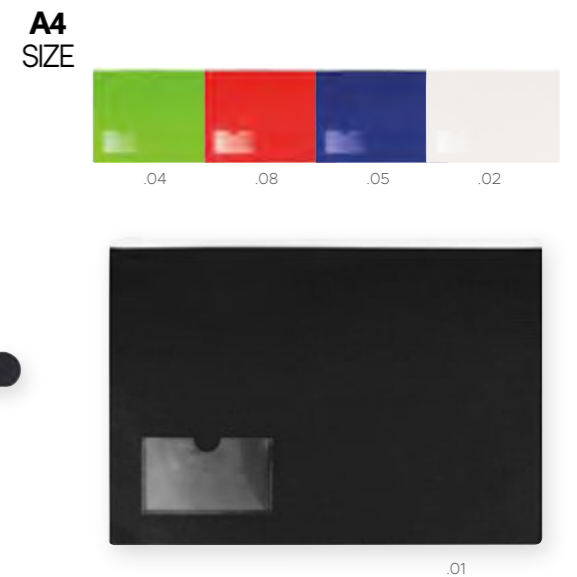

60213
Jing

Porta documenti con chiusura zip. Ha una finestra trasparente per inserire etichetta con nome o biglietto da visita. | Document holder made of non woven and zip closure. It has a transparent pocket to place on it business cards or name.

TNT No-woven | TNT No-woven

33 x 23,5 cm





A4
SIZE



62089
Monteviale



Portfolio A4 finitura mélange con chiusura magnetica. Comprende blocco da 30 fogli a righe, rimovibile. 4 tasche interne e portapenne. | Portfolio A4 mélange finish with magnetic closure. Includes pad of 30 lined, removable sheets. 4 inside pockets and pen holder.

RPET 600D | RPET 600D

24,5 x 31 cm



NATURAL CORK



A4
SIZE



62091
Padovana



Portfolio A4 con chiusura magnetica. Include blocco da 30 fogli a righe, rimovibile, 4 tasche interne e portapenne. | A4 portfolio with magnetic closure. Includes 30-sheet lined, removable pad, 4 inside pockets and pen holder.

Sughero | Cork

24,5 x 31 cm



RECYCLED CARDBOARD



40085
Margo



Cartellina con penna a sfera inclusa. Interno con blocco da 20 fogli bianchi. | rigidly recycled cardboard folder with recycled cardboard ball pen included. Inside with notepad of 20 blank sheets.

Cartoncino Riciclato | Recycled Cardboard

23 x 32 x 1,5 cm



A5
SIZE



62080
Pia

Portfolio A5 con chiusura magnetica. Powerbank da 4000mAh integrato. Comprende blocco da 63 fogli a righe e cavo di ricarica. | Folder size A5 with magnetic closure and power bank of 4000 mAh. It includes in its interior notebook with 63 lined sheets and charging cable.

Poliestere | Polyester

22,5 x 18 x 2,5cm



A4
SIZE



62987
Söderhamn

Porta documenti con supporto per smart phone e tablet. Con blocco con fogli a righe e calendario su ogni pagina, portapenna, tasca interna con diversi scomparti. Chiusura magnetica | Documents holder with tablet and smart phone support. With striped notebook and calendar on every page. Pen holder and pockets for cards and documents. Magnetic closure.

Similpelle | Leatherette

31 x 23,5 x 1 cm



A5
SIZE

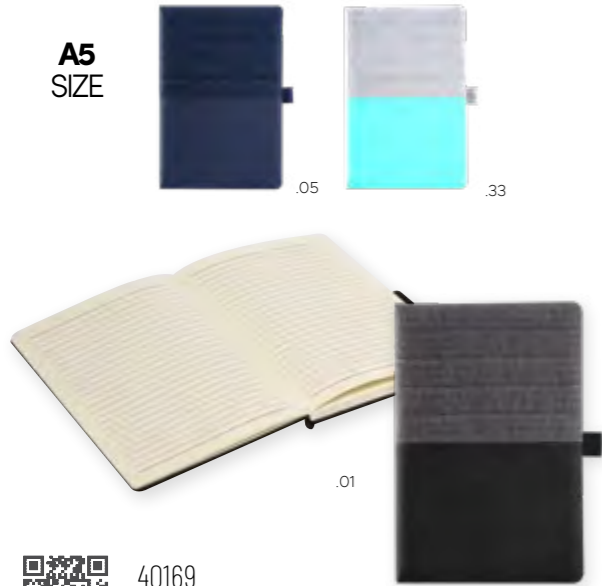

40169
Yuma

Notebook con copertina in PU e tessuto. Anellino porta penna. 80 fogli a righe color crema. | Notebook A5 with cover in PU and fabric. With pen loop. 80 lined sheets in cream colour.

Tessuto, Similpelle | Fabric, Leatherette

14,7 x 21 x 1,5 cm



A5
SIZE

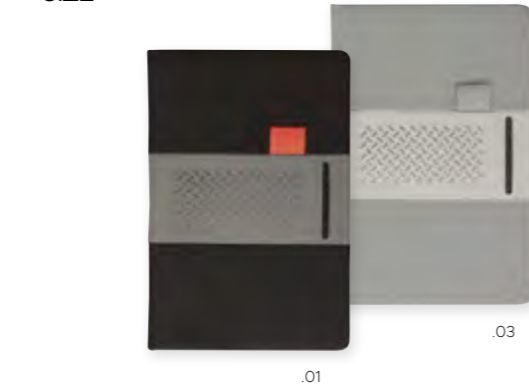

40177
Zambia

Notebook con copertina in PU. Fascia sulla copertina portapenna e porta biglietti da visita. | Notepad with PU cover. With a band on the cover that can be used as pen and card holder.

Similpelle | Leatherette

21 x 14 x 1,5 cm



A5
SIZE

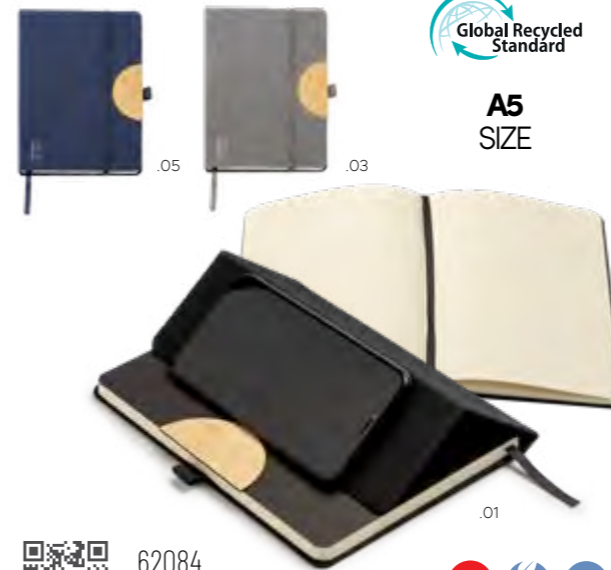

62084
Malo

Notebook A5 con copertina rigida con funzione di supporto per dispositivi mobili. Chiusura elastica, segnapagina e anellino portapenna. 80 fogli color crema lisci. | A5 hardcover notebook with stand function for mobile devices. Elastic closure, page marker and pen loop. 80 smooth cream colored sheets.

RPET | RPET

15 x 21 cm



A5
SIZE



62081
Gorgo

Notebook A5 con copertina rigida con funzione di supporto per dispositivi mobili. Segnapagina. 80 fogli color crema lisci. | A5 hardcover notebook with stand function for mobile devices. Page marker. 80 smooth cream colored sheets.

Bambù | bamboo

15 x 21 cm



A5
SIZE



40280
Stenstorp

Notebook con fascia elastica sulla copertina porta cellulare e porta penna. 80 fogli a righe color crema. | A5 notebook with polyester hardcover. Elastic holder on the cover. Lined sheets.

Poliestere | Polyester

14 x 21,5 cm



A5
SIZE



40279
Stäm

Notebook con fascia elastica sulla copertina porta cellulare e porta penna. 80 fogli a righe color crema. | A5 notebook with polyester hardcover. Elastic holder on the cover that can be used as phone holder and pen loop. Lined sheets in cream colour.

Poliestere | Polyester

14 x 21,5 cm



A5
SIZE



40289
Martellago

Notebook A5 con copertina rigida. Inserto sulla copertina con funzione portapenna e porta dispositivi mobili. 80 fogli color crema lisci. | A5 hardcover notebook. Insert on the cover with pen holder function and mobile device holder. 80 smooth cream colored sheets.

RPET | RPET

14,6 x 21,4 cm



PAPER WITH SEEDS

Petunia seeds included.



A6 SIZE
PAPER WITH SEEDS



40210
Draba



Notebook formato A6 con 4 fogli a righe. La carta contiene semi di petunia, basterà annaffiarla per far crescere la piantina. | A6 notepad with 4 ruled sheets. Petunia seeds included

Carta con semi | Paper with seeds

10 x 14 x 0,6 cm



A5 SIZE
PAPER WITH SEEDS



40255
Alluminio



Notebook con copertina in carta riciclata e biodegradabile con semi. 50 fogli in carta riciclata. | Notebook with semi-recyclable, degradable paper covers.

Carta Riciclata | Recycled paper

72 x 10 cm



RECYCLED CARDBOARD



B7 SIZE



40065
Muriel



Quadernetto con 30 fogli bianchi in carta riciclata. | Notebook with 30 recycled blank sheets

Carta | Paper

9,3 x 12,5 cm



RECYCLED CARDBOARD



A5 SIZE



40167
Vallentuna



Notebook con copertina morbida in cartoncino, con 60 pagine bianche | Notebook A5 with cardboard soft cover, with 60 white pages.

Cartoncino, Carta - 70gr/m2 | Cardboard, Paper - 70gr/m2

14,5 x 21 cm



RECYCLED CARDBOARD

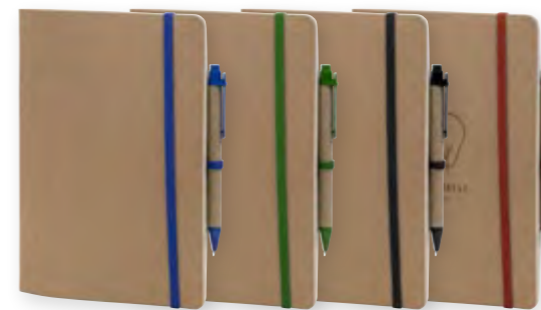

.23 .04 .01 .08



40184
Disueri



Quaderno con chiusura elastica, penna inclusa, con meccanismo a scatto, con dettagli colorati e coordinati con la chiusura elastica. | Notebook with elastic closure, pen included, with snap mechanism, with colored details and coordinated with the elastic closure.

Carta, Fibra di Grano, PP | Paper, Wheat Fiber, PP

14 x 21 cm



A5 SIZE



PAPER WITH SEEDS



.00



3005
Ficus



Cartolina ecologica, la carta contiene semi, basterà annaffiarla per far crescere la piantina. | Ecological postcard, the paper contains seeds, just water it to grow the seedling.

Carta con semi | Paper with seeds

15 x 10 cm



PAPER WITH SEEDS



.00



3003
Rosellina



Biglietto pieghevole ecologico, la carta contiene semi, basterà annaffiarlo per far crescere la piantina. | Folding card, the paper contains seeds, just water it to grow the seedling.

Carta con semi | Paper with seeds

30 x 14 cm



PAPER WITH SEEDS



.00



3001
Exacum



Biglietto da visita ecologico, la carta contiene semi, basterà annaffiarlo per far crescere la piantina. | Ecological business card, the paper contains seeds, just water it to grow the seedling.

Carta con semi | Paper with seeds

8,5 x 5,5 cm



PAPER WITH SEEDS

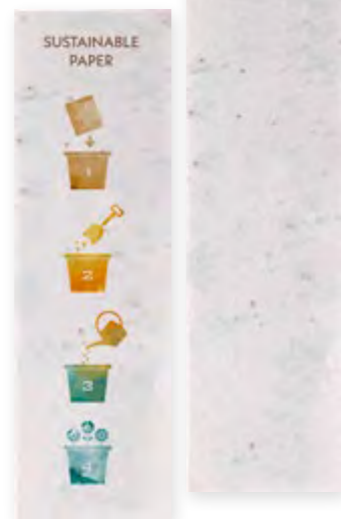

.00



3002
Loria



Segnalibro ecologico, la carta contiene semi, basterà annaffiarlo per far crescere la piantina. | Ecological bookmark, the paper contains seeds, just water it to grow the seedling.

Carta con semi | Paper with seeds

20 x 5 cm



CUSTOM PRODUCTS IN SEED PAPER

BLOCK NOTES

BUSINESS CARD

CHRISTMAS CARD

COASTER

BOOK MARK ...



THE PAPER CONTAINS SEEDS

with Chamomile, Poppy, Daisy, Rudbeckia, Peppermint, Lavander and Mix

RECYCLED CARDBOARD



A5
SIZE



40274
Koncis



Notebook con copertina in cartoncino. 100 fogli bianchi, chiusura elastica e segnapagina. | Notepad with in natural cardboard. 100 blank sheets, with elastic band and matching colour fabric bookmark.

Cartoncino Riciclato | Recycled Cardboard

14,7 x 21 x 1,5 cm

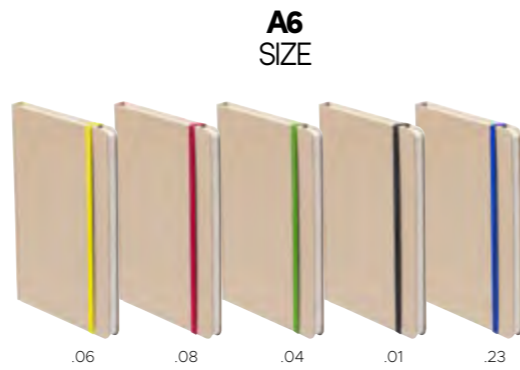

A6
SIZE

RECYCLED CARDBOARD



40275
Korken



Notebook con copertina rigida in cartoncino. Chiusura elastica colorata. 100 fogli bianchi. | Notebook with rigid cover. Coloured elastic closure. 100 blank sheets.

Carta Riciclata | Recycled paper

9,5 x 14,5 x 1,5 cm



A5
SIZE



RECYCLED LEATHER



40211
Canfora



Notebook con 80 fogli color crema, a righe, segnapagina e chiusura con elastico. | Notebook with 80 lined sheets cream paper. Comes with ribbon marker and elastic band closure.

Cuoio Riciclato | Recycled Leather

13,5 x 20,5 x 1 cm



A5
SIZE



RECYCLED LEATHER



40286
Fontaniva



Notebook A5 con copertina rigida. Anellino porta penna, segnapagina e chiusura elastica. 100 fogli color crema a righe. | A5 hardcover notebook. Pen loop, page marker and elastic closure. 100 lined cream sheets.

Pelle riciclata | Recycled leather

14,5 x 21 cm



NOTEBOOK MADE OF RECYCLED LEATHER

With 80 lined
sheets of cream
paper.





40204
Alana



Notebook copertina rigida in RPET, composto da 80 fogli a righe. Con elastico e segnalibro in tessuto coordinato. Logo RPET sul retro | Notebook with hard covers in RPET, includes 80 single-stripe sheets. With elastic band and matching fabric bookmarks. RPET badge on the back.

Poliestere 600D RPET | 600D RPET polyester

14,7 x 21 x 1,5 cm



A5
SIZE

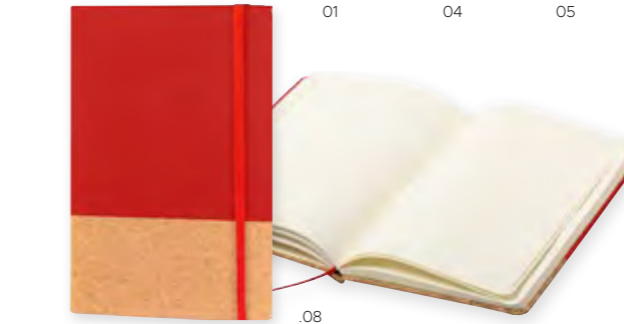
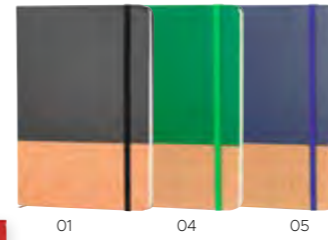

40925
Hollola



Notebook con chiusura elastica e segnapagina. 96 pagine senza righe, color crema. | Notebook with cover made of PU and cork, elastic band closure and page marker. Includes 96 plain cream-colored sheets inside.

Sughero, Similpelle | Cork, Leatherette

14 x 21 cm A5



A6
SIZE

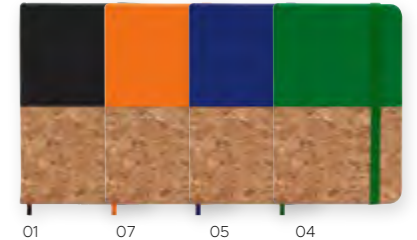

40206
Kia



Notebook con copertina rigida in sughero e similpelle. Chiusura elastica e segnapagina coordinati. | Notebook Rigid mixed cork / leatherette cover. Bookmark and elastic band.

Similpelle, Sughero | Leatherette, Cork

9,3 x 1,5 x 14,3 cm

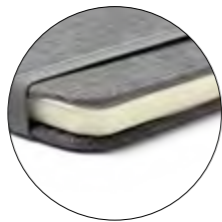

A5
SIZE



40287
Guarda



Notebook A5 con copertina rigida. Segnapagina e chiusura elastica coordinati. 80 fogli. | A5 hardcover notebook. Coordinated page marker and elastic closure. 80 sheets.

RPET | RPET

14,7 x 21 cm



A5
SIZE

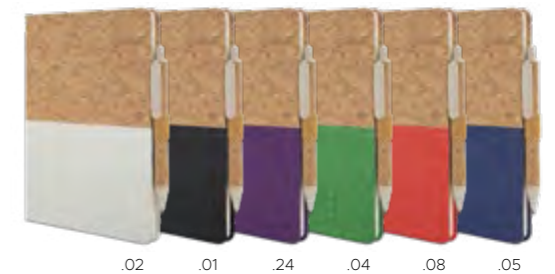

40263
Carbonera



Notebook A5 con copertina rigida, metà in sughero e metà in cotone lino, fornito con penna a sfera con meccanismo a scatto, fusto in sughero. | A5 notebook with hardcover, half in cork and half in cotton linen, supplied with ballpoint pen with click mechanism, cork barrel.

Notebook: Sughero/Cotone lino. Pen: Sughero/PP Eco | Notebook: Cork/Linen Cotton. Pen: Cork/PP Eco

14 x 21 cm



A6
SIZE



.11



40236
Babil



Notebook, 80 fogli a righe, chiusura elastica e segnapagina colorati. | Notepad with cover in natural cork. 80 lined sheets, with elastic band and matching colour fabric bookmark.

Sughero | Cork

10 x 14,5 x 1,5 cm



A5
SIZE



.11



40176
Lifer



Notebook con copertina rigida in sughero, 80 fogli bianchi color crema, chiusura elastica e segnapagina coordinati. | Cork notepad with hard covers. Including 80 plain sheets in kraft colour finishing, elastic band and fabric bookmark.

Sughero | Cork

14 x 21 cm



A5
SIZE



.13



40245
Carapellotto



Notebook con copertina rigida in cotone e sughero. 80 fogli bianchi. Anellino porta penna. Include penna a sfera | Notepad with cotton and cork hardcover. 80 blank sheets. Pen loop. Includes ballpen.

Sughero Naturale, Cotone | Natural Cork, Cotton

14,5 x 22 x 1,5 cm



A6
SIZE



.13



40217
Ajowan



Notebook con copertina rigida in sughero. Segnapagina e chiusura elastica. 80 fogli. | Notebook with hard cover in cork. Elastic closure and coordinated page markers

Sughero | Cork

8,9 x 14 x 1,4 cm



A5
SIZE



.13



40290
Peschiera



Notebook A5 con copertina rigida. Segnapagina e chiusura elastica coordinati. 80 fogli color crema lisci. | A5 hardcover notebook. Coordinated page marker and elastic closure. 80 smooth cream colored sheets.

Sughero | Cork

14 x 21 cm



A5
SIZE



.13

SHEETS MADE OF
STONE PAPER



40260
Cariano



Notebook speciale con fogli in carta pietra, con copertina resistente in carta kraft. 50 fogli bianchi in carta pietra. | Special notebook with sheets of stone paper, with resistant kraft paper cover. 50 white sheets of stone paper.

Cartoncino, carta pietra | Cardstock, stone paper

13,8 x 21 cm



NOTEBOOKS MADE OF GRASS PAPER



STRIPES IN SOY INK

A5
SIZE

Notebook made with the recycling of milk cartons



40262
Carrè



Notebook: A5 con copertina rigida, realizzato con il riciclo di cartoni di latte e utilizzando inchiostri a base di soia per la stampa delle righe nelle pagine. Chiusura con elastico, segnapagina coordinato. | A5 hardcover notebook, made with the recycling of milk cartons and using soy-based inks to print the lines on the pages. Elastic closure, coordinating page marker.

Cartoncino Riciclato | Recycled Cardboard

14,5 x 21 cm



The Components of Milk Cartons.

Milk Cartons are made up of a number of components which are layered:

- Paperboard (made from wood)
- Polyethylene (a type of plastic)
- Aluminum.

1000 milk cartons can instead of a tree



A5
SIZE

.13



40258
Giavera



Notebook A5 con spirale, con copertina rigida in carta erba, 80 fogli a righe | A5 spiral notebook with grass paper hardcover, 80 striped sheets

Carta erba | Grass card

14,5 x 21 cm



A5
SIZE

.13



40261
Carrare



Notebook A5 con copertina rigida in carta erba, 80 fogli a righe, chiusura elastica e segnapagina. | A5 notebook with hardcover in grass paper, 80 lined sheets, elastic closure and page marker.

Carta erba | Grass card

14,5 x 21 cm

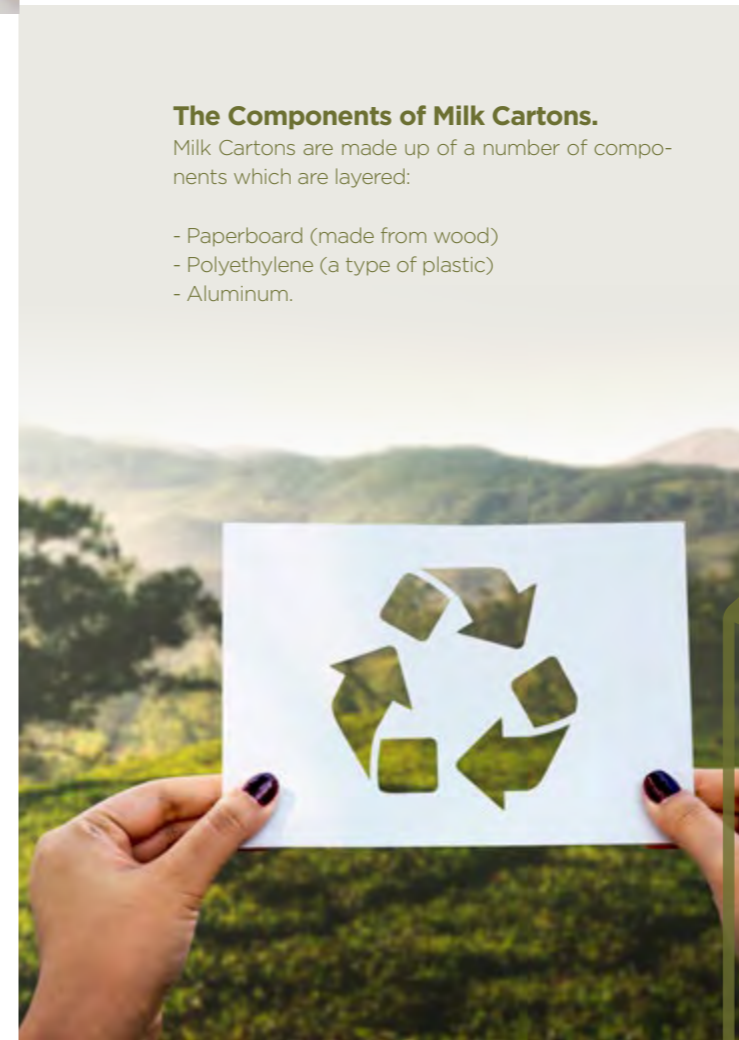

Milk Cartons are Recyclable!

When recycled, milk cartons can go on to be transformed into new paper products as well as eco-friendly materials rather than end up in a landfill.



A5
SIZE

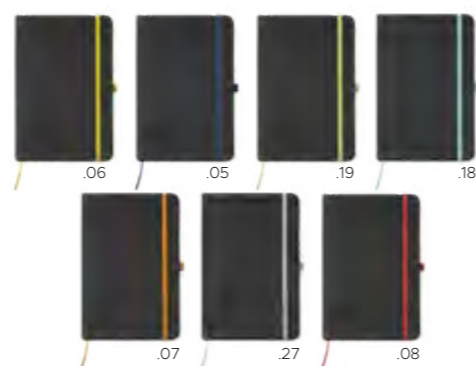

40157
Moomin

Notebook con copertina rigida, con chiusura elastica e anellino portapenna colorato coordinato. 80 fogli bianchi a righe. | Notebook with hardcover. With elastic closure and matching colour pen loop. 80 white lined sheets.

Similpelle | Leatherette

14,7 x 21 x 1,2 cm

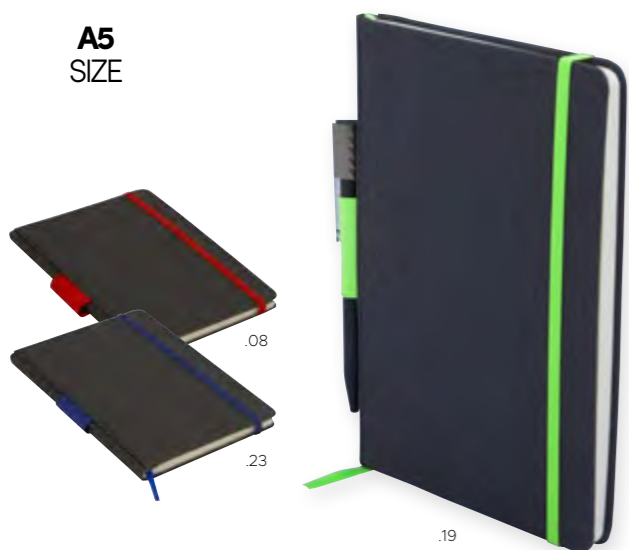

A5
SIZE

A5
SIZE



40187
Alexandra

Notebook con copertina in poliestere, chiusura elastica e anellino portapenna sul dorso. 96 fogli a righe color crema. | Notebook with polyester cover. Elastic closure and pen loop in the spine. 96 lined sheets in cream colour.

Poliestere, Similpelle | Polyester, Leatherette

21 x 14 cm



40182
Mweru

Notebook A5 con copertina rigida in cartoncino. Copertina nera con chiusura elastica. 80 pagine bianche. | Notebook A5 size with cardboard hardcover. Black cover and colour elastic. 80 pages plain sheets.

Carta | Paper

14,7 x 21 x 1,1 cm

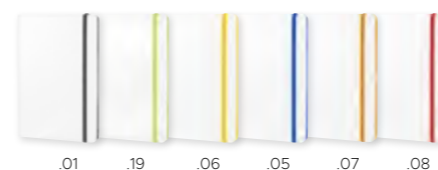

A5
SIZE



40163
Gonzaga

Notebook con copertina bianca soft touch. 100 fogli bianchi, con bordatura colorata, chiusura elastica e segnapagina coordinati. | Notepad with rigid soft-touch covers in white. 100 plain sheets with side in fun colours, elastic band and matching colour fabric bookmark.

Similpelle | Leatherette

14,5 x 21 x 1,5 cm

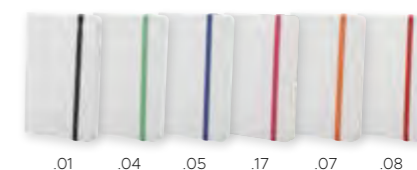

A6
SIZE



40105
Gadoni

Notebook con copertina rigida, composto da 80 fogli bianchi, chiusura elastica e segnapagina colorati coordinati. | Notepad with hardcover with white finish, including 80 blank sheets with elastic band and matching colour fabric bookmark.

Cartoncino | Cardboard

9 x 14 x 1,3 cm



.02



A5
SIZE



40198
Werner

Notebook antibatterico con copertina rigida in cartone laminato e fascia elastica di chiusura. 80 fogli bianchi. | Notebook with rigid cover made of antibacterial laminated white cardboard and elastic band closure with matching bookmark. Includes 80 blank sheets of white paper

Similpelle antibatterico, carta. | Antibacterial leatherette, paper.

15,5 x 21,5 x 1,3 cm



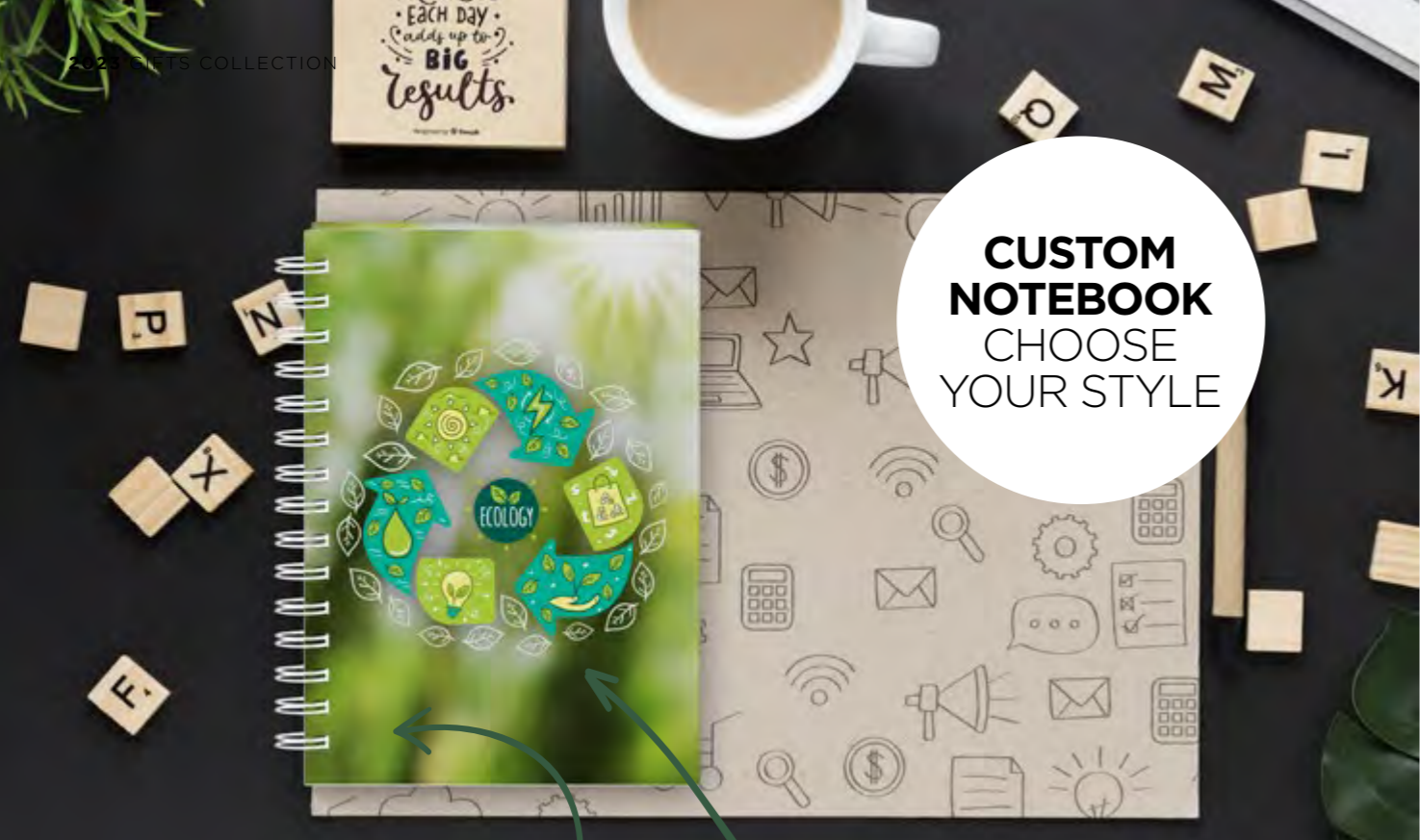

CUSTOM NOTEBOOK
CHOOSE YOUR STYLE

Scegli il colore della spirale che preferisci
Choose your favourite spiral colour

Crea la tua copertina esclusiva
Create your own unique notepad cover

CHOOSE YOUR FAVOURITE TEMPLATE



40190 Quinten
Blocco con spirale e copertina rigida | Hardcover collegeblock
15,4 x 21,5 cm



40191 Polinago
Blocco con spirale e copertina morbida | Softcover collegeblock
14,8 x 21 cm

NOTEBOOK

COMPLETELY CUSTOMIZABLE NOTEPADS
CHOOSE AMONG A WIDE RANGE OF COLOURS AND FINISHING OR USE YOUR OWN GRAPHICS.

Crea la tua copertina esclusiva
Create your own unique notepad cover

Scegli il tuo nastro colorato esclusivo
Pick your exclusive colored ribbon

Scegli il tuo colore d'elastico preferito
Choose your preferred elastic colour



40192 Pipa
Notebook con copertina rigida in cartoncino. | Hard cover notebook in cardboard.
15,5 x 21,5 cm

CREATE YOUR OWN UNIQUE NOTEPAD

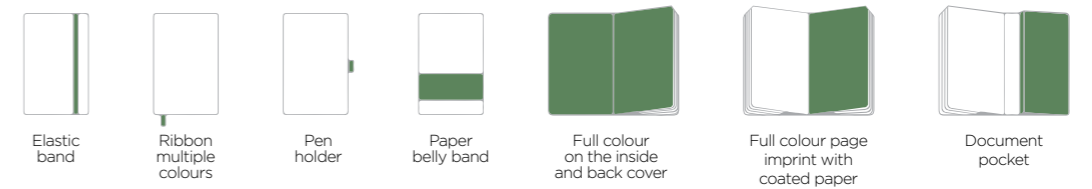

With soft touch cover



40193 Polistena
Notebook con copertina morbida in cartoncino. | Soft cover notebook in cardboard.
15,5 x 21,5 cm

Choose your PREFERRED COLOUR



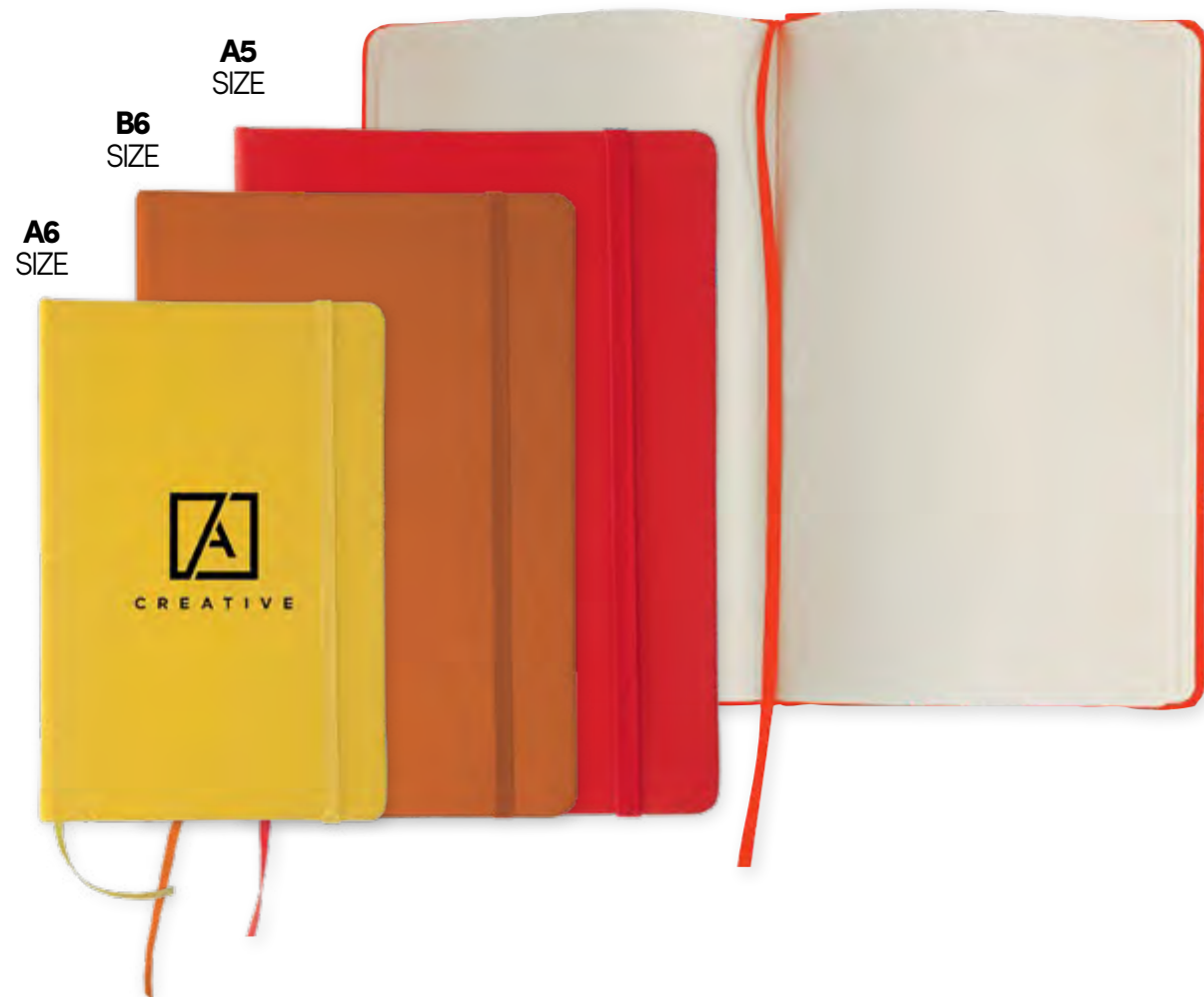

40074 Garm

Notebook con copertina soft touch. 100 fogli bianchi chiusura elastica e segnapagina coordinati. | Notepad with soft-touch covers. 100 blank sheets, with elastic band and matching colour fabric bookmark.

Similpelle | Leatherette
 14,7 x 21 x 1,5 cm
 A5 100

40921 Yozgat

Notebook con copertina rigida, chiusura elastica e segnapagina colorati coordinati. 96 pagine bianche | Notebook with rigid covers, matching elastic band fastening and bookmark. 96 blank pages inside.

Similpelle | Leatherette
 13 x 18 x 1,5 cm - B6
 B6 96

40031 Utina

Notebook con copertina soft touch. 100 fogli bianchi chiusura elastica e segnapagina coordinati. | Notepad with soft-touch covers. 100 blank sheets, with elastic band and matching colour fabric bookmark.

Similpelle | Leatherette
 14 x 9 x 1,4 cm
 A6 100

A5 SIZE



40305 Orfeo

Notebook con copertina in similpelle. 100 fogli a righe, chiusura elastica e segnapagina. | Notepad with cover in PU leather. 100 sheets with striped layout, with elastic band and matching colour fabric bookmark.

Similpelle | Leatherette
 14,5 x 21 x 1,5 cm
 A5 100

A5 SIZE



40994 Bergamo

Notebook con tasca sulla copertina. 80 Fogli a righe | Notebook with hardcover with pocket. 80 Lined sheets

Similpelle | Leatherette
 21 x 14 cm
 A5 80

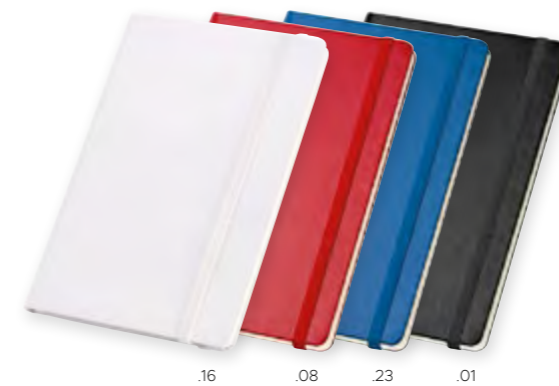

40126 Gante

Notebook con copertina rigida, chiusura elastica e segnapagina. Con tasca interna a fisarmonica. 80 fogli a righe color crema. | Notebook with hardcover. With elastic closure and page marker. With inner expandable pocket. 80 lined sheets in cream colour.

Similpelle | Leatherette
 13,7 x 21 cm
 A5 80



**A6
SIZE**

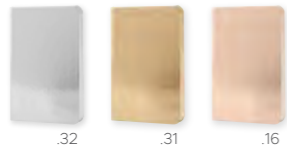

40284
Hola

Notebook con copertina in PU con finitura metallizzata. 80 pagine senza righe color crema. | Notebook with pu cover with metallic finish. Contains 80 plain cream coloured sheets inside.

Similpelle | Leatherette
9 x 1,5 x 14 cm A6



**A5
SIZE**



40283
Valverde

Notebook con copertina in similpelle, rigida, chiusura elastica e segnapagina colorati. 80 fogli bianchi color crema. | PU leather notepad. With hard covers, elastic band and matching colour fabric bookmark. Including 80 plain sheets in kraft colour finishing.

Similpelle | Leatherette
14,5 x 21 cm



**B6
SIZE**



40170
Stocksund

Set composto da notebook con copertina rigida e penna a sfera in metallo colorata coordinata. Fornita in confezione singola in cartoncino. | Set composed of notebook with hardcover, with elastic band fastening and matching ballpoint pen made of metal. Presented in cardboard box.

Metallo, Pu | Metal, Pu
Notebook: 13 x 18 x 1,5 cm (B6) / Pen: 13,5 cm



**A5
SIZE**



40172
Sunnersta

Set composto da notebook con copertina in similpelle, 96 pagine color crema a righe, bordatura delle pagine colorata, segnapagina nero. Fornito con penna nera coordinata, con meccanismo a torsione e gommino per touch screen. | Set consisting of notebook with leatherette cover, 96 cream-colored lined pages, colored page borders, black page markers. Supplied with matching black pen, with twist mechanism and rubber pad for touch screen.

Similpelle, Metallo, Cartone | Leatherette, Metal, Cardboard
14,5 x 1,5 x 21 cm

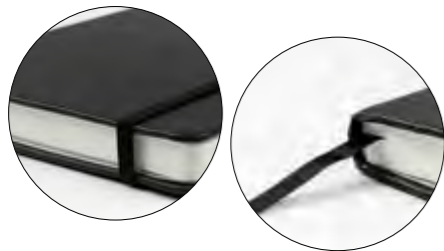

**A5
SIZE**



40304
Nuvola

Notebook con copertina rigida, 128 fogli assortiti. Tasca interna a fisarmonica, segnapagina, chiusura elastica e anellino portapenna. | Notebook with 128 assorted sheets inside. Includes an inner expandable pocket and a page marker. Elastic ribbon closure. Pen loop.

Similpelle, Carta | Leatherette, Paper
14 x 21 x 2 cm



32 pages striped | 32 pages smoothed | 32 pages squared | 32 pages with dots

**A5
SIZE**

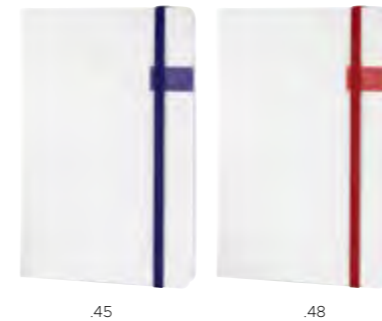

40185
Kankaanpä

Notebook con memoria usb da 16GB integrata nella copertina. Chiusura elastica, memoria USB e segnapagina colorati coordinati. 80 fogli a righe. | Notepad with 16GB USB flash drive integrated in the front cover. Elastic ribbon, USB memory and bookmark in matching colour. Including 80 sheets with striped outline.

Similpelle | Leatherette
14 x 21 cm A5



NOTEBOOKS

With sheets in cream colour.



A6
SIZE



.01



40231
Suzhou

Notebook con chiusura elastica e segnapagina. Con tasca interna a fisarmonica. 80 fogli senza righe color crema. | Notebook with PU hardcover. With elastic closure and page marker. With inner expandable pocket. 80 blank sheets in cream colour.

Similpelle | Leatherette

9,7 x 14,5 cm



A5
SIZE



.01



40095
Lina

Notebook con chiusura elastica e segnapagina. Con tasca interna a fisarmonica. 80 fogli senza righe color crema. | Notebook with PU hardcover. With elastic closure and page marker. With inner expandable pocket. 80 blank sheets in cream colour.

Similpelle | Leatherette

13,7 x 21 cm



A5
SIZE



.01



40160
Gobots

Notebook con copertina rigida, con chiusura elastica e segnapagina. 80 fogli color crema, a quadretti. | Notebook with hardcover. With elastic closure and page marker. 80 squared sheets in cream colour.

Similpelle | Leatherette

14,7 x 21 x 1,5 cm



A4
SIZE



.01



40159
Givoletto

Notebook con copertina rigida, con 80 fogli senza righe color crema. | Notebook with hardcover. 80 blank sheets in cream colour.

Similpelle | Leatherette

14 x 21 x 29,3 cm



**A6
SIZE**



40303
Ovidio

Notebook con copertina in velluto, 80 pagine senza righe, color crema. | Notebook with cover made of velvet and 80 blank cream coloured sheets inside.

Velluto, Carta | Velvet, Paper

11 x 14,5 cm



**A6
SIZE**



.08 .07 .19 .23



.01



40070
Riami

Notebook con copertina morbida. Chiusura con laccio. | Notebook with soft cover in PU. Closure with cord.

Similpelle, Carta | Leatherette, Paper

8,5 x 12 cm



**A5
SIZE**



40301
Norton

Notebook con 30 pagine a righe, color crema. Certificato FSC. | Notebook with 30 cream coloured striped sheets inside. FSC certificated.

Carta | Paper

14 x 21 cm



**A7
SIZE**



.21



40013
Neta

Notebook con pagine bianche senza righe, fornito con penna a sfera con meccanismo a scatto, coordinata, inchiostro nero | Notebook with blank pages without lines, supplied with matching ballpoint pen with click mechanism, black ink

Plastica | Plastic

8 x 10,5 x 1 cm



**A5
SIZE**

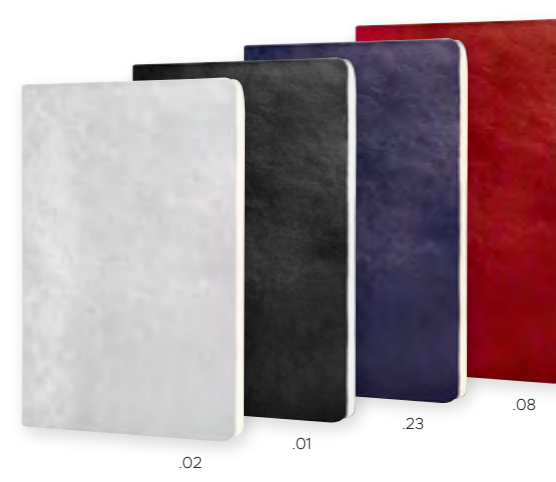

40300
Macho

Notebook con copertina morbida. 96 pagine color crema, segnapagina coordinato. | Notebook with flexible cover, with 96 striped sheets inside and matching bookmark.

Similpelle, Carta | Leatherette, Paper

14 x 21 x 1,5 cm



**A7
SIZE**



.05

.04



40161
Diamond

Notebook con chiusura con fascetta elastica. Segnapagina, fogli bianchi. Include penna a sfera con gommino per touch screen. | Notebook with cardboard hardcover. Closure with elastic band. Page marker, blank sheets. Includes ballpoint with pointer for touch screen.

Similpelle | Leatherette

10 x 7,5 cm



NOTEPADS WITH PEN

Made of 100% bamboo.



BAMBOO WOOD



A6 SIZE



40178
Östana



Notebook con spirale con copertina rigida. Con chiusura elastica e anellino porta penna. Fogli a righe. | Notebook with bamboo hardcover with spiral. With elastic closure and pen loop. Lined sheets.

Bamboo, Carta 70gr/m2 | Bamboo, Paper 70gr/m2

13,5 x 18 cm



.11

BAMBOO WOOD



A5 SIZE



40091
Javan



Notebook con spirale, 70 fogli senza righe color avana. Con chiusura elastica nera. Include penna a sfera con meccanismo a scatto. | Notepad with spiral, hardcover made in bamboo, 70 blank sheets in kraft colour. With black elastic closure. Includes ballpen.

Bamboo | bamboo

13,5 x 18 cm



.11

BAMBOO WOOD



A6 SIZE



40094
Juul



Notebook con spirale, 70 fogli senza righe color avana. Con chiusura elastica nera. Include penna a sfera con meccanismo a scatto. | Notepad with spiral, hardcover made in bamboo, 70 blank sheets in kraft colour. With black elastic closure. Includes ballpen.

Bamboo | bamboo

10,5 x 14,8 cm



.11

BAMBOO WOOD



A5 SIZE



40254
Katahdin



Notebook con spirale con copertina in bambù, 70 pagine senza righe color avana. Anellino portapenna fissato con rivetto metallico. Comprende penna coordinata. | Notebook with bamboo covers with spiral, and 70 smooth kraft sheets inside. Pen loop with metal rivet. It has a matching pen.

Bamboo | bamboo

15 x 1,5 x 18 cm



.11

BAMBOO WOOD



A5 SIZE



40252
Coppa



Notebook con spirale con copertina rigida in bambù. 80 fogli senza righe. Include penna a sfera | Notepad with spiral bamboo hardcover. 80 blank sheet. Includes ballpen with bamboo barrel and chromed details. Black ink.

Bamboo | bamboo

22,5 x 2 x 21,5 cm



.11

RECYCLED CARDBOARD



**A6
SIZE**



40040
Justi



Notebook con spirale. Chiusura elastica e penna a sfera inclusa. 70 fogli a righe, anellino portapenna. | Ring notebook with elastic fastening and ball pen in matching colour. 70 sheets with striped, ball pen holder.

Cartoncino Riciclato | Recycled Cardboard

16,5 x 14,6 x 0,8 cm



**A5
SIZE**



40256
Piadina



Notebook con penna a sfera coordinata con meccanismo a scatto. 60 fogli bianchi lisci. | Notebook with matching ballpen with push-up mechanism, and 60 blank white sheets inside.

Carta, cartoncino | Paper, cardboard

14 x 21 cm

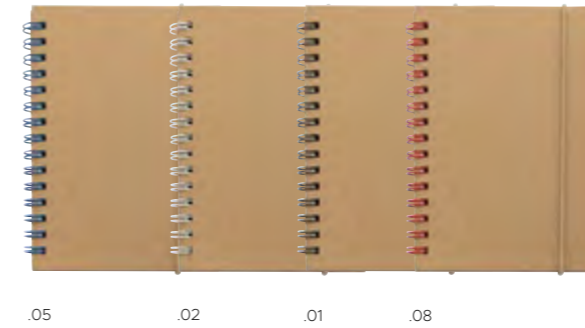

40257
Wuhan

Notebook con spirale colorata e copertina rigida, chiusura con elastico in tinta con la copertina. Comprende 70 fogli bianchi a righe. | Notebook with colored spiral and hard cover, elastic closure matching with the color of the cover. Includes 70 white lined sheets.

Cartoncino, carta | Cardstock, paper

10 x 14 cm



**A6
SIZE**



.04

RECYCLED CARDBOARD

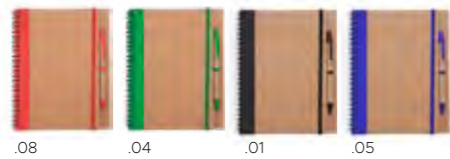

**A5
SIZE**



40026
Akule



Notebook con spirale con copertina rigida, chiusura elastica e penna a sfera. 60 fogli bianchi. Anellino portapenna. | Ring notebook with elastic fastening on the cover and ball pen in matching colour recycled cardboard. 60 blank sheets with ball pen holder on back cover.

Cartoncino Riciclato | Recycled Cardboard

16,5 x 21 x 1 cm

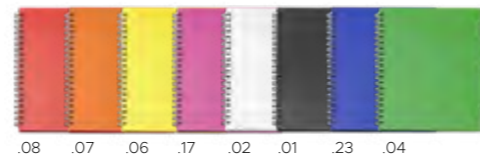

RECYCLED CARDBOARD



40277
Knalla



Notebook con spirale e penna a sfera coordinata. 70 fogli bianchi. Portapenna | Ring notebook with cover in recycled cardboard and ball pen in matching colour recycled cardboard. 70 blank sheets and with ball pen holder on back cover.

Cartoncino Riciclato | Recycled Cardboard

15 x 18,2 x 1,9 cm



**A5
SIZE**



40141
Vladimir

Notebook con copertina rigida in cartoncino con spirale. 80 fogli bianchi. | Notebook with cardboard cover with spiral and 80 plain pages.

Cartoncino, Carta | Cardstock, Paper

15,5 x 21 cm - A5



RECYCLED CARDBOARD



**A5
SIZE**



40212
Carciofi



Notebook in carta riciclata, con spirale, 60 pagine a righe color avana. | Spiral notebook with 60 sheets havana color.

Carta Riciclata | Recycled paper

14 x 21 cm



**A5
SIZE**



**B6
SIZE**



40154
Manama

Notebook con spirale, 100 fogli bianchi a righe. Comprende penna con gommino per touch screen. | Notebook with spiral and 100 white lined pages. Touch ballpen.

PP, Carta | PP, Paper

17 x 21,5 x 1 cm - A5



29023
Muraco

Notebook con spirale, con 100 fogli a righe, fornito con penna a sfera con meccanismo a scatto. | Spiral notepad, 100 lined sheets, supplied with ballpen with click action mechanism.

Plastica | Plastic

14,5 x 2 x 15,9 cm



40237
Beck

Mini notebook con spirale e mini penna a sfera nella copertina, con porta penna elastico. 60 pagine a righe. | Ring mininotebook with mini ball pen on cover and carrying lanyard. 60 sheets with striped layout.

PP | PP

7 x 9,5 x 0,7 cm



**A6
SIZE**



40162
Grimaldi

Notebook con spirale con 30 fogli a quadretti. | Notebook with spiral with 30 squared sheets.

Carta di pietra, Plastica | Stone Paper, Plastic

15 x 10 cm



STONEPAPER NOTEBOOK WITH SPIRAL





 **96058 Payat**
Righello da 8 cm, apribuste con lente di ingrandimento. | Letter opener ruler with magnifying glass. 8cm.
Plastica | Plastic
8,5 x 5,5 cm

 **29064 Tupi**
Tagliacarte con righello incorporato da 12 cm | Letter opener with built-in 12cm ruler with an ergonomic grip.
Plastica | Plastic
16,5 x 3,3 x 0,3 cm

 **29026 Telu**
Apribuste | Letter opener
Plastica | Plastic
8 x 6 x 0,3 cm



 **29161 Wale**
Dispenser per nastro adesivo. Nastro incluso | Adhesive tape dispenser. Tape included
Plastica | Plastic
10 x 5,8 x 4 cm



 **40992 Bergeggi**
Calendario perpetuo con supporto | Perpetual calendar in smooth finishing with folding holder.
Plastica | Plastic
14 x 9 x 4 cm



 **29271 Diveria**
Aprilettere | Letter opener
Zinco | Zinc
7 x 5,5 x 0,4 cm



 **29307 Tientsin**
Cucitrice professionale elegante, pratica e sobria. | Elegant, practical and sober professional stapler.
Plastica | Plastic
16 x 3,7 x 6 cm



 **29996 Alezio**
Scatolina porta graffette con cassetto, contiene 20 graffette. | Drawer box pack of paper clips, 20 pieces
Plastica | Plastic
7,5 x 4 x 1,5 cm



.02



35082
Seren



Porta penne con orologio multifunzione integrato. Funzioni di termometro, calendario e sveglia, timer e promemoria per il compleanno. | Pen holder with integrated multifunction clock. Thermometer, calendar and alarm clock, timer and birthday reminder functions.

Bamboo, Abs | Bamboo, abs

10,2 x 11,9 x 5,4 cm



.11



.11



.11



27053
Garda



Calcolatrice a 10 cifre alimentata con solar power | 10-digit calculator powered by solar power

Fibra di grano, Abs, Bamboo | Wheat Fiber, Abs, Bamboo

17x 9,8 x 1,2 cm



35090
Caorle



Portapenne con orologio integrato. | Pen holder with integrated clock.

Bamboo | bamboo

7,5 x 13 x 7,5 cm



35091
Candiana



Portapenne. Funzioni: Temperatura, sveglia, ora e calendario. | Penholder. Functions: Temperature, Alarm, Time and Calendar.

Bamboo | bamboo

7,5 x 9,5 x 7,5 cm





27051
Shenzhen



Lavagna magica con calcolatrice integrata a 12 cifre. Fornita con pennino per la scrittura. Cancellazione automatica premendo l'apposito pulsante. Carica microusb. | Magic board with built-in 12-digit calculator. Supplied with writing pen. Automatic cancellation by pressing the appropriate button. Rechargeable via microusb.

Bamboo | bamboo

📏 24,3 x 47,5 cm



.00



.32



29075
Andres

Porta telefono/portapenna con pinza porta memo | Mobile phone and pen holder, with memo clips

Plastica | Plastic

📏 7,7 x 9,3 x 6,5 cm



.32



29281
Theta

Porta penne cilindrico | Round metallic pencil bucket made of aluminium.

Alluminio | Aluminum

📏 Ø 6,5 x 10 cm



.00



35050
Flori

Porta penne con orologio da tavolo con indicazione temperatura, calendario e sveglia. | Pen holder with desk clock with indoor temperature, calendar and alarm, includes battery.

Plastica | Plastic

📏 9,8 x 11,7 x 7,5 cm



.08



.23



27052
Canton

Calcolatrice professionale extra large a 12 cifre, display e numeri grandi. Funziona sia con batterie (incluse) oppure con energia solare. | Professional extra large 12-digit calculator, display and large numbers. It works either with batteries (included) or with solar energy.

Pvc, Alluminio | Pvc, Aluminum

📏 15 x 12 cm



.05



35080
Elena

Portaoggetti da tavolo con orologio, batterie escluse | Support for objects with clock. Batteries not included

Plastica | Plastic

📏 12 x Ø 9 cm



.23



29993
Lackhjr

Portapenne da scrivania | Desk pencil case

Plastica | Plastic

📏 6,5 x 6,5 x 8,5 cm





29316
Trevignano

Porta penne | Pen holder
Sughero | Cork
7,5 x 7,5 x 10 cm



.11



.00



29278
Cephalanthus

Portapenne in cotone, 8 cm di diametro. | Pencil holder made cotton, 8 cm diameter.
Cotone | Cotton
Ø 8 x 9 cm + folder 2,5 cm

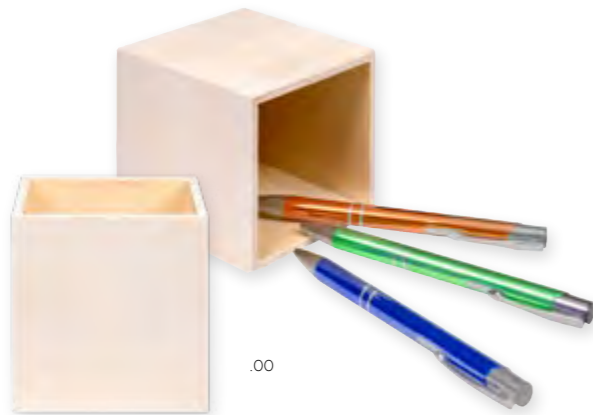

.00



95120
Värdera

Porta penne | Pencil case made of wooden panel
Legno | Wood
8 x 8 x 9 cm



.13



40215
Afnio

Cartolina di legno spessore 4 mm | 4mm poplar wood postcard.
Legno di pioppo | Poplar wood
15 x 10 cm



.13



96194
Totma

Set composto da astuccio, una matita, una temperamatite, una gomma e un righello da 15cm. | Set including a case made of cotton, a natural wooden pencil, a natural wooden pencil sharpener, a rubber and a ruler.

Cotone, Legno | Cotton, Wood
19,5 x 7 cm





.13



99027
Singapore



Astuccio, zip coordinata e piccoli inserti laterali | Case in natural colour, matching colour zipper and handy side handles

100% Cotone | 100% Cotton

220 gr/m²
Ø 6,5 x 22,5 cm



.13



99049
Spinea



Astuccio con tirazip in metallo. | Case with metal zip puller.

Cotone riciclato | Recycled cotton

21 x 6 x 6 cm



.23

.01

.08



96161
Palladio



Astuccio con tirazip con cordino | Pouch with drawstring puller

Poliestere 600D RPET | 600D RPET polyester

20 x 4,5 x 6 cm



NATURAL CORK



.13



99052
Ishigaki



Astuccio porta penne, zip coordinata, tirazip cromato e fodera interna bianca. | Pencil case in natural cork. Matching colour zipper, chromed puller and inner lining in white colour.

Sughero | Cork

23 x 11 x 2 cm



.13



40270
Socker



Astuccio con due matite in legno, penna a sfera, righello da 15cm, temperamatite, gomma e block notes. Chiusura con zip. | Pencil case with 2 wooden pencils, ballpen, ruler 15cm, pencil sharpener, rubber and memo pad. Zip closure

Poliestere | Polyester

21 x 16,5 x 2 cm



.00



40993
Bergarud



Block notes da scrivania con penna con meccanismo a scatto, righello in legno da 15cm e graffette. | Desk Block notes with pen with click action mechanism, 15cm wooden ruler and clips.

Cartone | Cardboard

25 x 18 cm



RECYCLED CARDBOARD



.06 .23 .19



29299
Hood

Gomma a forma di contenitore per i rifiuti per la raccolta differenziata. Con coperchio apribile. | Eraser in the form of a garbage container and recycling, with opening lid. Available in different colours.

Gomma | Eraser

1,8 x 3 x 4 cm

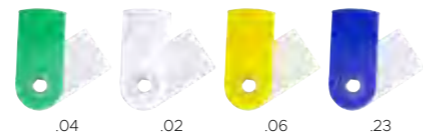

.04 .02 .06 .23



.08



29995
Isiro

Gomma twister | Rubber

Gomma | Eraser

5,5 x 3,3 cm



30 CM

16 CM



.11

.11



96132
Punky

Righello, 16 cm | 16 cm wooden ruler

Legno | Wood

17 x 2,5 x 0,3 cm



96129
Word

Righello, 30 cm | 30 cm wooden ruler

Legno | Wood

31 x 2,5 x 0,3 cm



.02 .23 .08



29225
Cristallo

Gomma per cancellare con custodia | Rubber with plastic cover

Gomma | Eraser

6,5 x 3,5 x 1,5 cm



.18 .02 .17 .08 .19 .01



29000
Cicoria

Gomma per cancellare | Oval-shaped eraser.

Gomma | Eraser

6,5 x 1 x 4 cm

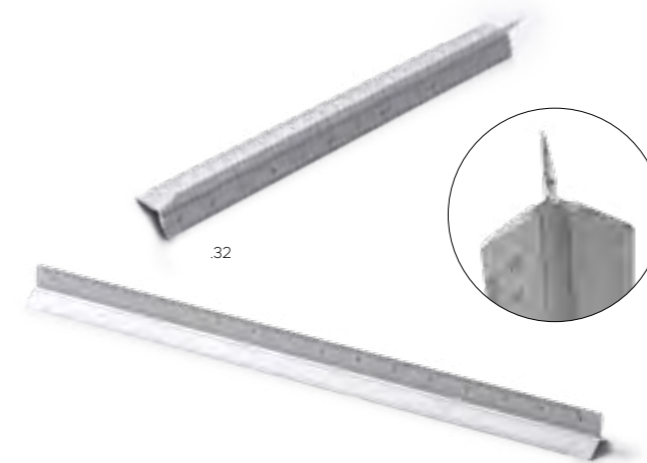

.32

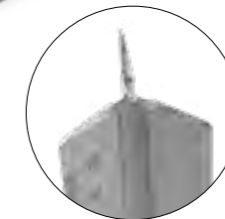

96166
Morubio

Righello dal design triangolare, lunghezza 30 cm. Scala da 1:20, 1:25, 1:50, 1:75 e 1:100. Un lato liscio, ideale per la personalizzazione. | Triangular design ruler, length 30cm. Scale of 1:20, 1:25, 1:50, 1:75 and 1:100. One smooth side, ideal for personalisation.

Alluminio | Aluminum

32 x 2 cm



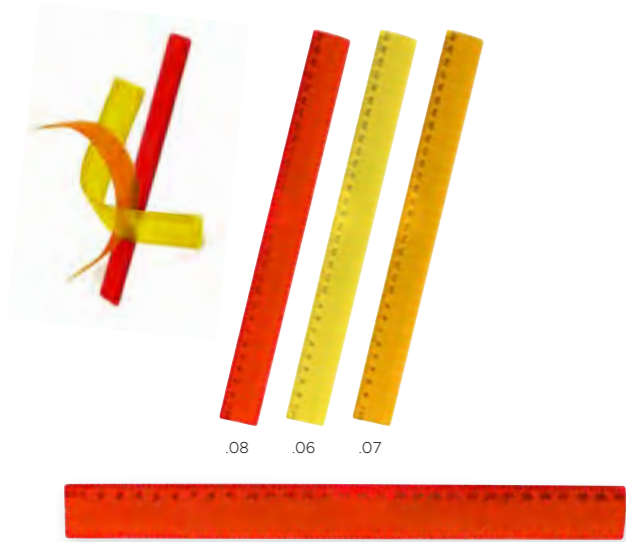

.08 .06 .07



96000
Overland

Righello flessibile 30 cm. | Flexible ruler 30 cm long

Pvc | pvc

31,5 x 3,8 x 0,2 cm



MADE IN ITALY

.07 .06 .23 .19 .04 .02 .18

.08



96095
Metairie

Righello 30 cm | Ruler 30cm.

Plastica | Plastic

30 x 3 cm



8x folding magnifier with built-in ruler



82537
Anfus

Lente di ingrandimento 8X. Con righello integrato. | 8x folding magnifier. With built-in measuring ruler

Plastica | Plastic

3 x 4 x 4 cm



MADE IN ITALY

Ruler with magnifying glass



96884
Lackftig

Righello 30 cm con lente di ingrandimento e apertura per inserire inserto pubblicitario | 30 cm ruler with magnifying glass and opening to insert paper.

Plastica | Plastic

31 cm



.02



29274
Erro

Righello flessibile, misura 30 cm | Flexible ruler (30cm/12inches)

Pvc | pvc

5,8 x 11,5 x 0,1 cm



.02



29272
Erebus

Segnalibro con righello da 8 cm e lente d'ingrandimento | Bookmark and 8cm ruler with a magnifier

Pvc | pvc

8,4 x 5,3 x 0,1 cm



.21



96054
Nodin

Righello con lente d'ingrandimento. 15cm | Ruler with magnifying glass. 15 cm.

Plastica | Plastic

18,5 x 4,5 x 0,3 cm



.32



24012
Noumea

Set da ufficio con calcolatrice (8 cifre), penna a sfera e righello da 15cm (centimetri e pollici). Fornito in confezione regalo. | Office set with 8-digit calculator, 15cm ruler (centimetres and inches) and ballpen with click action mechanism. Supplied in a gift box

Metallo, Plastica | Metal, Plastic

17 x 24 x 3,5 cm





STICKY NOTEPADS

Made of paper.



.13

**A4
SIZE**



40216

Aglio



Portafolio con blocco appunti da 20 pagine e segna pagina adesivi colorati. Manico fustellato. Portapenna. Penna inclusa. | Cardstock portfolio, with 20-page notepad and colored sticky page markers. Pen included.

Cartoncino | Cardboard

28,5 x 2 x 34,5 cm



.05 .04 .01 .08

**A5
SIZE**

RECYCLED CARDBOARD



40987

Bloemhof



Blocchetto con foglietti adesivi con penna a sfera. Chiusura con patella. Copertina rigida in cartoncino riciclato. | Sticky notepad with recycled cardboard ball pen included and original flap closure. Cover in rigid recycled cardboard.

Cartoncino Riciclato | Recycled Cardboard

14,5 x 1 x 20 cm



.13



40116

Buenos Aires



Notebook con 50 fogli bianchi e foglietti adesivi in 5 colori assortiti. Fustellato per contenere la penna coordinata, inclusa. | Notebook made of cardboard with 50 smooth pages inside and with sticky notes in five assorted colours and a matching small ballpoint pen

Cartoncino, Carta | Cardstock, Paper

Notebook: 9 x 0,5 x 11,5 cm, Ball Pen: 9,5 cm



.00

RECYCLED CARDBOARD



29298

Feccia



Blocchetto con copertina. Include 200 fogli bianchi 7,5x8cm e 125 segnapagina colorati 1,5x5cm. | Notepad with recycled cardboard hardcover. Includes 200 blank sheets 7,5x8cm and 125 coloured pagemaker 1,5x5cm.

Cartone riciclato | Recycled cardboard

8,1 x 2,6 x 8,3 cm



RECYCLED CARDBOARD



.00



29324

Behaga



Blocchetto di foglietti adesivi. 100 foglietti grandi e 125 piccoli | notepad with covers in resistant, rigid recycled cardboard. With 100 large sticky notes and 125 mini sticky notes.

Cartoncino Riciclato | Recycled Cardboard

10,8 x 8,5 x 2,5 cm

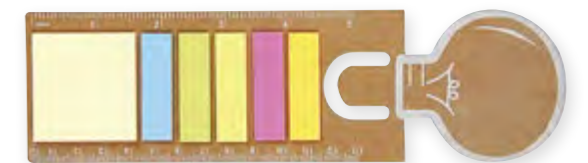

.00



40181

Rukwa



Segnalibro a forma di lampadina, con righello (cm e pollici), con foglietti adesivi in diversi colori e misure. | Light bulb-shaped bookmark and ruler (inches and centimetres) including sticky notes in different colours and sizes.

Cartoncino | Cardboard

6 x 21 cm





40011
Varma



Foglietti memo in box di cartoncino. 200 foglietti color avorio | Memo sheets in cardboard box. 200 ivory colored sheets

Carta | Paper
8,1 x 8 x 2,4 cm



29291
Ypsilon



Set da scrivania a forma di cubo composto da porta penne, foglietti per appunti (250 fogli) e 180 foglietti adesivi in vari colori in due formati. | Cube shaped desk set made up of : pencil, notepad and sticky notes in various colors.

Cartoncino | Cardboard
9 x 9 x 9 cm



29267
Blomskog



Blocchetto con foglietti adesivi, con copertina rigida bianca lucida. Comprende 25 foglietti adesivi 7,5x5cm, 125 segnapagina colorati e 100 foglietti adesivi 7,5x10cm. | Sticky note pack with a hard cover in shiny white colour with 25 sticky notes of 7,5 x 5 cm, 125 coloured page market and 100 sticky notes of 7,5 x 10 cm.

Cartoncino, Carta | Cardstock, Paper
8,3 x 10,5 x 1,7 cm



29268
Blonduos



Blocchetto con spirale e copertina rigida. Comprende 75 foglietti adesivi 7,5x5cm e 125 segnapagina colorati. | Sticky note pad with spiral and hard cover. Includes 75 coloured sticky notes of 7,5 x 5 cm and 125 coloured page markers.

Carta, Cartoncino | Paper, cardboard
7,5 x 2,5 x 8,5 cm



29266
Blois



Notebook con spirale e righello disegnato sulla copertina. Include 25 foglietti adesivi 4,5x4cm, 125 segnapagina colorati e un blocco con 40 fogli a righe | Sticky note pad with spiral and a ruler painted in its cover. Includes 25 sticky notes of 4,5 x 4 cm, 125 coloured page markers and a notebook of 40 stripped sheets.

Carta, Cartoncino | Paper, cardboard
13 x 5,3 x 1,3 cm

RECYCLED CARDBOARD

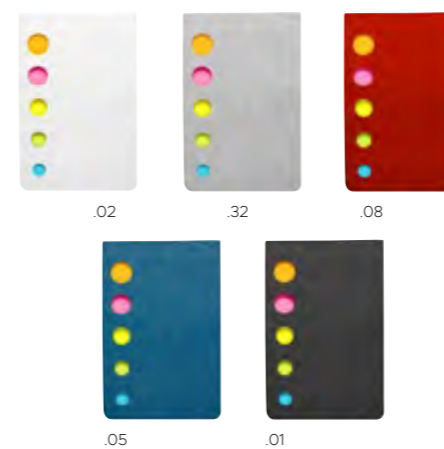

29094
Darice



Segnapagina adesivi. 100 foglietti adesivi | Sticky notepad with die-cut, soft-touch cover in recycled cardboard. 100 mini sticky notes.

Carta Riciclata | Recycled paper
8,2 x 6 x 0,3 cm



STICKY NOTES

CUSTOMIZABLE RANGE OF STICKY NOTES

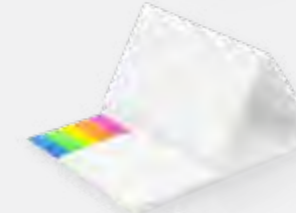

29350
Monrovia 
Calendario con struttura rigida con 12 fogli e 50 foglietti adesivi. | Hardback calendar with 12 sheets and with 50 sticky notes
19,4 x 21 cm 

29351
Monreale 
Calendario con struttura morbida, 12 fogli. | Softback calendar with 12 sheets
15 x 17,5 cm 



FLEXIBLE OR RIGID COVER



29347 
Oppeano
Notebook, 100 foglietti adesivi 10x7,2cm, 25 da 5x7,2cm e 20 segnapagina in 5 colori. | Hard cover notepad with 100 sticky notes of 10x7,2cm, 25 of 5x7,2cm and 20 markers in 5 colours.
10,6 x 7,7 cm



29348 
Ora
Notebook con 50 foglietti adesivi (80 gsm) da 10x7,2 cm, 25 da 4,8x7,2cm e 20 segnapagina in 5 colori. | Notepad soft cover with 50 sticky notes (80 gsm) of 10x7,2 cm, 25 of 4,8x7,2cm and 20 markers in 5 colours.
10 x 7,5 cm



29349 
Nolinsk
Foglietti adesivi con copertina morbida con 25, 50 o 100 foglietti. | Sticky notes in softcover with 25 or 50 or 100 sticky notes
10 x 7,2 cm



29352 
Nomaglio
Foglietti adesivi basic, disponibili con 25, 50 o 100 foglietti. | Sticky notes basic with 25 or 50 or 100 sticky notes
7,2 x 7,2 cm



29353 
Monopoli
Foglietti adesivi basic, disponibili con 25, 50 o 100 foglietti. | Sticky notes basic with 25 or 50 or 100 sticky notes
10 x 7,2 cm

Travel and Business

Zaini da viaggio e multifunzione,
trolley, adattatori da viaggio, porta
documenti da viaggio e borse per il
fine settimana.

Travel & multifunction backpacks,
travel trolleys, travel adapters, purses
& weekend travel bags.

Travel

and Business



.06 .01



.01 .07 .08



.08 .02 .05 .19



.07 .08 .19 .23 .01



.04



.06



60029
Lubbe

Borsa porta documenti con manico, tracolla regolabile, chiusura con fibbie e diverse tasche porta documenti. Con pannello organizer sotto la patella. | Conference bag with handle, adjustable shoulder strap, buckle closure and several document pockets. Organizer panel under the flap.

Nylon | Nylon

39,5 x 29,2 x 7,5 cm



60058
Zenon

Borsa conference con chiusura zip, manici rinforzati e finiture cucite. | Conference bag in non-woven material, with zipper closure, reinforced handles and stitched finishing.

TNT No-woven | TNT No-woven

37,5 x 26 cm



60141
Bodaappa

Borsa porta documenti con manico, chiusura zip e anellini portapenna all'esterno sui lati. | Conference bag with carry handle, zipper closure and pen loops on the outside

Poliestere | Polyester

36 x 27 cm



60080
Harriet

Borsa conference in TNT per documenti in formato A4, con chiusura zip, un manico e finiture cucite. | TNT conference bag for A4 size documents, with zipper, one handle and a sewn trim.

TNT No-woven | TNT No-woven

36 x 26 cm



.05 .13 .08



.29 .05 .07

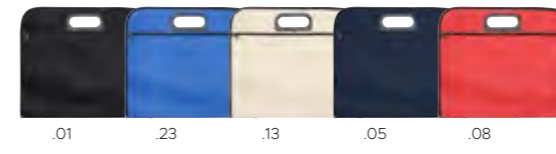

.01 .23 .13 .05 .08



.02 .01 .23 .05 .04 .08 .07



.08



60116
Nuuk

Borsa porta documenti con patella con chiusura in velcro. Piping nero. Tracolla regolabile, scomparto interno per penne. | Document bag with velcro closure flap in resistant non-woven, black colour piping. With adjustable shoulder strap and inside compartments for pens.

TNT No-woven | TNT No-woven

36,2 x 30 x 9 cm



60061
Aros

Porta documenti con chiusura zip. | Document case with zipper closure.

TNT No-woven | TNT No-woven

34,5 x 25,5 cm



60162
Rho

Portadocumenti con scomparto principale e chiusura a zip. Profili con rinforzo e maniglia integrata nel design. | Document holder with main compartment and zipper closure

Poliestere 600D | 600D polyester

38 x 32 cm



60165
Roentgenio

Portadocumenti disponibile in vari colori con maniglia e cerniera coordinata. | Document holder in various colours with handle and matching zip.

Poliestere 600D | 600D polyester

40 x 5,5 x 30,5 cm



.01



60094
Palmer

Borsa tracolla con scomparto interno imbottito porta tablet. Tasca frontale con zip. Chiusura con fibbia. Tracolla regolabile. | Shoulder bag with inside padded compartment for tablet. Front zippered pocket. Buckle closure. Adjustable shoulder strap.

Nylon 800D | 800D nylon

24 x 30 x 6 cm



.01



60004
Galeno

Borsa porta documenti, manici e tracolla | Document bag with front vertical zip

Poliestere 600D | 600D polyester

37 x 29 x 8,5 cm



.29



60039
Vreni

Borsa porta documenti con chiusura zip. Tasca frontale con zip. Manici rinforzati. Tracolla regolabile. | Conference bag with zipper closure. Front pocket with zip. Reinforced handles. Adjustable shoulder strap.

Poliestere 600D | 600D polyester

40 x 30 x 10 cm



60006
Efrest

Borsa porta documenti, ampio scomparto principale con chiusura zip nera, manici resistenti, piping a contrasto sul fronte. | Document bag, large main compartment with black zip closure, resistant handles, contrasting piping on the front.

Poliestere 600D | 600D polyester

38 x 28 x 10 cm



60153
Bogotol

Borsa porta documenti con scomparto principale con zip. Ampia tasca frontale con doppia chiusura con fibbia. Manico rinforzato. Tracolla regolabile. | Conference bag with main compartment with zipper closure. Large front pocket with double buckle closure. Reinforced handle. Adjustable shoulder strap.

Poliestere 600D | 600D polyester

38 x 29 x 9 cm



.19



60092
Siuntio

Borsa porta documenti con scomparto principale con zip. Fodera interna. Manici rinforzati. | Conference bag with main compartment with zipper closure. Bicolour design with decorative stitching. Inside lining. Reinforced handles.

Poliestere 600D | 600D polyester

37 x 27 x 5 cm



.19



60161
Renio

Borsa congress con ampio scomparto principale e tasche esterne per contenere penne o smartphone | Congress bag with large inner space and outer pockets for keeping pens or mobile phone.

Poliestere 600D | 600D polyester

36 x 8 x 28 cm



.13



.01

.13

.04

.07

.08



60160
Marani

Borsa conference porta documenti e porta computer, tasca imbottita per laptop.
| Conference bag with padded compartment for laptop.

Poliestere 600D | 600D polyester

36 x 6 x 27 cm



.23



60142
Alba

Borsa porta computer imbottita con tasca esterna. Manico di trasporto abbinato e tracolla regolabile con moschettone. | Padded document bag for notebook with outer pocket. Matching carrying handles and adjustable shoulder strap with carabiner.

Poliestere 600D | 600D polyester

40,5 x 5,5 x 30 cm



.01



60169
Lazise



Custodia porta computer da 13", etichetta RPET all'esterno. | 13" computer case, RPET label on the outside.

Poliestere riciclato RPET 300D | 300D RPET recycled polyester

34 x 24 x 3 cm



.03



60106
Stavropol

Borsa porta documenti con chiusura zip. Tasca esterna con chiusura in velcro, manici rinforzati, tracolla regolabile con aggancio con moschettone, fascia sul retro. | Document bag with zipper closure in polyester. External pocket with velcro closure, reinforced handles, adjustable shoulder strap with carabiner closure and accessory at the back

Poliestere 600D | 600D polyester

37,5 x 8 x 29 cm



.01



60170
Lavagno



Custodia porta computer da 15", etichetta RPET all'esterno. | 15" computer case, RPET label on the outside.

Poliestere riciclato RPET 300D | 300D RPET recycled polyester

39 x 26,5 x 3,5 cm



COMPUTER CASE

Made in polyester.

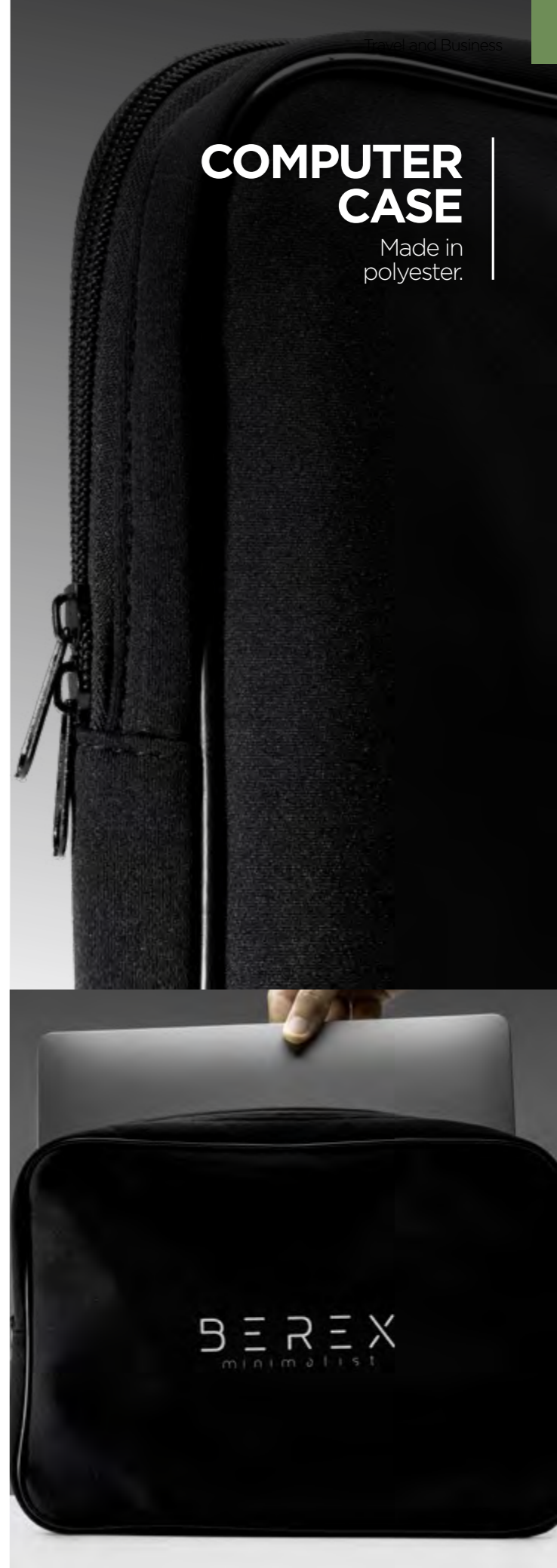

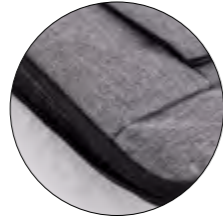

.03



60164
Rodio

Custodia porta computer con scomparto interno imbottito adatto a contenere portatili dimensione massima 15,6 | Laptop bag with an inner padded finish for laptops up to 15.6 inches.

Poliestere RPET 600D | 600D RPET polyester

39 x 28,5 x 2,7 cm



.03

.05



60168
Danta

Custodia porta computer da 13" | 13" laptop case

Neoprene | Neoprene

39,5 x 29 x 3,5 cm



.03

.01



43172
Phoenix

Pouch formato A4 realizzata in PU imbottito, con tirazip in metallo. | Multipurpose bag size A4 made of padded pu with metal zipper puller.

Similpelle | Leatherette

31 x 22,5 cm



.13

.01



60171
Pojana

Custodia per computer, adatta per laptop da 14". | Computer case, suitable for 14" laptops.

Cotone riciclato - 330 gr/m2 | Recycled cotton - 330 gr/m2

34 x 2 x 27 cm



.13



60172
Crocetta

Borsa conferenza porta computer, con manici corti e tracolla regolabile. Adatto per laptop da 16". | Conference computer bag, with short handles and adjustable shoulder strap. Suitable for 16" laptops.

Cotone riciclato - 330 gr/m2 | Recycled cotton - 330 gr/m2

37 x 6 x 28 cm



PADDED DOCUMENTS CASE

Made in recycled cotton.



60167
Grumolo



Borsa porta computer, scomparto imbottito adatto per laptop fino a 15". Tasca frontale, manici confortevoli e tracolla regolabile. | Computer bag, padded compartment suitable for laptops up to 15". Front pocket, comfortable handles and adjustable shoulder strap.

Poliestere RPET 300D | 300D RPET polyester

39 x 28 x 5 cm



64287
Gaultheria



Zaino borsa 2 in 1, con finitura impermeabile. Imbottitura interna ed esterna. Fascia per agganciarlo al trolley. Dotato di manico per trasportarlo come borsa. | Congress backpack and bag 2 in 1, with a waterproof finishing. It is padded inside and outside. Fastening strap to be hold in trolleys and also in the handles when used as a bag.

Poliestere 300D, 50% RPET | 300D polyester, 50% RPET

31 x 46 x 11 cm



64260
Mirano



Zaino con ampio scomparto principale con zip. Tasca interna imbottita porta computer, passante per auricolari, tasca frontale con zip. Manico imbottito. Schienale imbottito e spallacci regolabili. | Backpack made of RPET material, with main zippered compartment. It has inner padded pocket suitable for laptop, headphone output, front zippered pocket. Padded handle. Padded back and adjustable shoulder straps.

RPET | RPET

29 x 11 x 40 cm



60147
Amaryllis



Portadocumenti imbottito per laptop realizzato in RPET dal design vigoré. Due scomparti con cerniera impermeabile. Manici per il trasporto abbinati e tracolla regolabile. Fascia per trolley. | Padded documents case for your laptop made of RPET in heather finish. Two compartments with waterproof zip. Matching handles and adjusting shoulder strap. Trolley strap included.

RPET 600D | RPET 600D

37 x 28 x 5 cm



64275
Alloro



Zaino dal design vigoré. Corpo imbottito e tasca interna ideale per laptop. Doppio scomparto con cerniera impermeabile e tasca esterna. Spallacci imbottiti e fascia per trolley. | Backpack ideal for your laptop. Double compartment. Padded shoulder straps and trolley strap.

RPET 600D | RPET 600D

31 x 42 x 12 cm



64284
Canomilla



Zaino in RPET, tasche frontali con zip, reti laterali, scomparto interno per laptop 15", rinforzi sulla schiena e sulle maniglie. | Backpack made of RPET material, with front zipper pockets, side mesh, internal laptop 15" compartment, reinforcements on the back and handles.

Poliestere 420D 70%, RPET 30% | 420D Polyester 70%, RPET 30%

34 x 54 x 20 cm





RPET CONGRESS BACKPACKS

With padded compartments for laptops up to 15 inches and tablets up to 10 inches.



64237
Bubi



Zaino in RPET, etichetta esterna con il logo RPET. Tasca principale con scomparti imbottiti per notebook fino a 15 pollici e tablet fino a 10 pollici. Schienale e spallacci imbottiti. | Backpack RPET, it includes an external label with the RPET logo. Main pocket with padded compartments for laptops up to 15 inches and tablets up to 10 inches. Padded back and shoulder straps.

Poliestere 600D RPET | 600D RPET polyester

31 x 45 x 13 cm



.03



.83



64305
Selenio



Zaino con chiusura antifurto. Porta di connessione usb. Scomparto imbottito per laptop e tablet. Fascia posteriore. | Backpack with anti-theft zippers. USB connection

Poliestere RPET 300D | 300D RPET polyester

33 x 12 x 46 cm



.03



64306
Senape



Zaino con schienale e spallacci imbottiti, scomparto interno imbottito portacomputer, porta usb e cavo, tasche laterali, due scomparti esterni, fascia posteriore per trolley. | Backpack made of RPET, with padded and reinforced back and straps

RPET 300D, Similpelle | RPET 300D, Leatherette

32 x 15,5 x 46 cm



.01



64286
Gallardia



Zaino borsa 2 in 1, con finitura impermeabile. Imbottitura interna ed esterna. Fascia per agganciarlo al trolley. Dotato di manico per trasportarlo come borsa. | Congress backpack and bag 2 in 1, with a waterproof finishing. It is padded inside and outside. Fastening strap to be hold in trolleys and also in the handles when used as a bag.

Poliestere 300D, 50% RPET | 300D polyester, 50% RPET

32 x 16 x 44 cm



.03



64285
Fotinia



Zaino congress con finitura impermeabile, imbottitura interna ed esterna. Dotato di fascia per agganciarlo al trolley. Uscita USB. | Congress backpack with waterproof finish, interior and exterior padding. It has a clamping band for placement on trolleys and USB output.

Poliestere 300D, 50% RPET | 300D polyester, 50% RPET

45 x 30 x 16 cm





.05

.01



64317
Ezzelini



Zaino porta computer con scomparto interno imbottito. Dotato di porta USB. Fascia posteriore per agganciarlo al trolley. Dotato di due tasche frontali, una a scomparsa. | Computer backpack with padded internal compartment. Equipped with a USB port. Back strap to attach it to the trolley. Equipped with two front pockets, one retractable.

Poliestere RPET 300D | 300D RPET polyester

29 x 41 x 12 cm



.01

.05



64316
Godega



Zaino porta computer con due scomparti principali, uno imbottito porta pc. Tasca laterale in rete. Due tasche frontali. Dotato di porta USB. Schienale imbottito. Spallacci regolabili. | Computer backpack with two main compartments, one padded computer holder. Side mesh pocket. Two front pockets. Equipped with a USB port. Padded backrest. Adjustable shoulder straps.

Poliestere RPET 300D | 300D RPET polyester

31,5 x 47 x 13 cm



64250
Borello



Zaino porta computer melange. Scomparto interno imbottito, porta computer e tablet, dotato di uscita USB per connettere il powerbank (non incluso). Tasca frontale con zip, tasca laterale. Spallacci e schienale imbottiti. | Melange computer backpack. Padded inner compartment, computer and tablet holder, equipped with USB output to connect the powerbank (not included). Front zip pocket, side pocket. Padded shoulder straps and back.

Poliestere RPET 600D | 600D RPET polyester

29 x 43 x 13 cm



.05

.03

.01

BACKPACKS MADE OF RPET

Equipped with
USB output.





.03



64318

Giorgio

NEW

Zaino porta computer in similpelle, finitura soft touch resistente all'acqua, scomparto interno porta computer, tasca frontale con zip, tasche laterali. Tasca antifurto sullo schienale. Spallacci imbottiti. | Leatherette computer backpack, water-resistant soft touch finish, internal computer compartment, front zip pocket, side pockets. Anti-theft pocket on the back. Padded shoulder straps.

Similpelle | Leatherette

30 x 45 x 15 cm



LEATHERETTE COMPUTER BACKPACKS

Water-resistant
soft-touch finish.



.01



64217

Bogorodskoe

Zaino business con due scomparti principali con chiusura zip, uno di essi imbottito porta computer. Diverse tasche interne nello scomparto imbottito. Due tasche frontali con zip. Due tasche laterali, una di esse con all'interno una uscita USB. Schienale i | Backpack with two main compartments with zipper closure, one of them padded for laptop. Several inner pockets in the padded compartment. Two front pockets with zipper closure. Two side pockets, one of them with usb output inside. Padded back and adjustabl

Similpelle | Leatherette

33 x 18,5 x 44 cm



.01



64259

Clitunno

NEW

Zaino borsa porta documenti con scomparto principale con zip. Interno imbottito porta computer. Manico laterale. Schienale e spallacci regolabili imbottiti. Fascia per trolley. | Document bag backpack with main compartment with zipper closure. Inside padded compartment for laptop. Side handle. Padded back and adjustable padded straps. Fitting accessory for trolley.

Poliestere 300D, Similpelle | 300D Polyester, Leatherette

32 x 41 x 12,5 cm



.01



64240

Eurajoki

Zaino porta documenti impermeabile. Scomparto principale con chiusura zip antifurto. Tasca anti-furto RFID. Fascia per agganciarlo al trolley. Due tasche frontali con zip. Uscita USB e uscita audio con jack da 3.5mm. Schienale imbottito e spallacci reg | Congress backpack made of waterproof polyester. Main compartment with anti-theft zipper closure. At the back it has an anti-theft pocket with RFID protection, as well as a band for a better placement on trolleys. 2 zippered front pockets. It also has USB

Poliestere Impermeabile | Polyester Waterproof

32 x 20 x 46 cm



.01

.05



64220

Espoo

Zaino porta computer impermeabile con due scomparti principali con zip. Scomparto interno imbottito per laptop. Tasca antifurto RFID. Fascia per agganciarlo al trolley. Due tasche frontali con zip. Dotato di uscita USB e uscita audio con jack da 3.5mm. S | Congress backpack made of waterproof polyester with 2 main zippered compartments. Inner padded compartment for laptop max size 15.6". At the back it has an anti-theft pocket with RFID protection and a fastening strap to be hold in trolleys. 2 zippered for

Poliestere Impermeabile | Polyester Waterproof

45 x 30 x 16 cm





.03



64243

Eura

Zaino porta computer con scomparto imbottito per portatili. Tasca frontale con zip. Dotato di uscita USB e uscita audio con jack da 3.5mm. Schienale imbottito e spallacci regolabili. | Congress backpack heathered. Inside padded compartment for laptop max size 15.6". Front zippered pocket. USB output and 3.5 audio jack. Padded back and adjustable straps.

Poliestere 600D Effetto Melange | 600D Polyester Melange Effect

30 x 11 x 41 cm



.01

.23



64204

Aquadilla

Zaino effetto melange. Ampio scomparto principale con chiusura zip, tasca frontale con zip, passante per auricolari, maniglia superiore imbottita colorata coordinata, tasca laterale in rete, spallacci regolabili. | Backpack melange effect. Large main compartment with zip closure, front zip pocket, earphone loop, matching colored padded top handle, side mesh pocket, adjustable shoulder straps.

Poliestere 600D | 600D polyester

31 x 13,5 x 43 cm



.03



64338

Scala

NEW

Zaino portacomputer finitura melange, ampio scomparto principale con scomparto interno imbottito adatto per laptop, tasca interna con zip, due scomparti interni aperti. Tasca frontale obliqua con chiusura con zip. Uscita USB. Tasche con zip nascoste sul retro per protezione dai furti. | Laptop backpack with Melange finish, large main compartment with internal padded compartment suitable for laptop, internal zip pocket, two internal open compartments. Front slanted pocket with zip closure. USB outlet. Hidden zip pockets on the back for theft protection.

Poliestere 600D | 600D polyester

26 x 13 x 45 cm



.05

.03

.01



64339

Tonezza

NEW

Zaino portacomputer con inserto frontale in similpelle. Ampio scomparto principale imbottito, con chiusura zip, adatto a contenere portatili misura 15". Tasca frontale con zip. Tasche laterali in rete. Maniglia e spallacci imbottiti e regolabili. | Computer backpack with faux leather front insert. Large padded main compartment, with zip closure, suitable for holding 15" laptops. Front pocket with zip. Side mesh pockets. Padded and adjustable handle and shoulder straps.

Poliestere, Similpelle | Polyester, Leatherette

33 x 42 x 11 cm



.01

.03



64324

Cartura

NEW

Zaino porta computer finitura oxford dal design innovativo. Tasca interna principale imbottita adatta per contenere un laptop. Due tasche frontali con chiusura zip. Elegante manico. Dotato di porta usb per connettere il vostro powerbank (non incluso). Sch | Oxford finish computer backpack with an innovative design. Padded main inner pocket suitable for holding a laptop. Two front pockets with zip closure. Elegant handle. Equipped with a USB port to connect your powerbank (not included). Padded back and shoul

Poliestere 300D | 300D polyester

31 x 43 x 16 cm



.03



64216

Bogopol

Zaino porta computer effetto jeans. Scomparto interno imbottito per portatili. Tasca frontale con zip. Maniglia e schienale imbottiti. Spallacci regolabili. | Laptop backpack made of polyester in a jeans finish. Inside padded compartment for laptop max 14

Poliestere Effetto Jeans | Jeans Effect Polyester

32 x 14 x 44 cm



.03



64288

Merlo

Zaino porta computer effetto jeans. Scomparto interno imbottito per portatili dimensione max 15.6". Dispone inoltre di un'uscita USB per il collegamento del powerbank (non incluso). | Laptop backpack in a jeans finish. Inside padded compartment for laptop max 15.6". It also includes a USB output.

Poliestere Effetto Jeans | Jeans Effect Polyester

32 x 14 x 44 cm





64213
Bocchigliero

Zaino antifurto porta computer, resistente all'acqua, anti taglio e resistente all'usura. Tasca antifurto. Scomparto interno con uscita USB per connettere il powerbank (non incluso). Cerniera di sicurezza, due scomparti interni imbottiti, separati. Schienale | Anti theft, business laptop backpack water repellent, cut and wear resistant. Anti theft pocket at the back for keeping valuable objects. Inside compartment with USB output for powerbank connection. Security zipper, 2 padded, inside, independent, compartm

Poliestere 600D | 600D polyester

35 x 47 x 15 cm



64534
Himmelsk

Zaino porta computer impermeabile. Scomparto interno con uscita USB. Include un cavo micro USB da 1 metro. Scomparto interno imbottito per portatili. Spallacci e schienale con imbottitura ergonomica | Waterproof laptop backpack in high quality nylon. With inside compartment with USB output for powerbank connection -not included-. Including micro USB cable of 1 meter length. With padded inside compartment for laptops. A wide range of inside and outside

Nylon | Nylon

45 x 30 x 20 cm



64212
Enontekiö

Zaino antifurto, impermeabile, resistente al taglio e all'usura. Tasca antifurto. Include cavo microusb da 1 metro. Due scomparti interni imbottiti. Spallacci e schienale con imbottitura ergonomica. | Anti theft, waterproof, business backpack in high quality nylon, cut and wear resistant. Anti theft pocket at the back for valuable objects. Inside compartment with USB output for powerbank connection -not included-. Including micro USB cable of 1 meter

Nylon 1200D | 1200D nylon

30 x 44 x 16 cm



64157
Hindu

Zaino porta computer con chiusura zip. Tasche frontali con zip e doppio manico rinforzato. Scomparto interno imbottito per laptop. | Laptop backpack with zipper closure, front pockets and reinforced double handle. Inside padded compartment for laptops.

Nylon 600D | 600D nylon

44 x 25 x 32,5 cm





64187
Grossotto

Zaino con ampio scomparto principale con chiusura con doppia zip e scomparto interno imbottito porta computer. Due scomparti con chiusura zip. Schienale imbottito e spallacci regolabili imbottiti. | Backpack with large main compartment with double zipper closure and inside padded compartment for laptop. Two compartments with zipper closure. With padded back and adjustable shoulder straps with padding.

Poliestere | Polyester

46 x 35 x 15



64290
Rubidio

Zaino portacomputer con finitura melange. Spallacci, schienale e maniglia imbottiti. Doppio scomparto anteriore porta computer, adatto a contenere un portatile da 15". Tasche laterali. | Computer backpack with melange finish. Padded shoulder straps, back and handle. Double front computer compartment, suitable for holding a 15" laptop. Side pockets.

Poliestere | Polyester

43 x 28 x 13 cm



64535
Voxnan

Zaino porta computer con due scomparti principali con zip. Scomparto interno imbottito per portatili. Tasca frontale con patella e chiusura in velcro. Altra tasca frontale con zip. Manico in metallo. Schienale imbottito e spallacci regolabili. | Laptop backpack with 2 main zippered compartments. Inside padded compartment for laptop. Front pocket with flap with velcro closure. Another zippered front pocket. Reinforced metal handle. Padded back and adjustable straps.

Poliestere | Polyester

32 x 12 x 42 cm



64037
Pueblo

Trolley con due ruote. Scomparto principale con chiusura con doppia zip. Tasche interne | 2 wheeled trolley in resistant polyester. Main compartment with double handle zipper closure. With inside pocket.

Poliestere 600D | 600D polyester

27 x 53 x 27 cm



66061
Casale



Zaino trolley porta computer. Ampio scomparto principale imbottito ideale per contenere un portatile misura 15". Due tasche con scomparti interni. Tasca frontale con zip. Spallacci imbottiti regolabili. Copertura per le ruote antimacchia, scomparto per ri | Computer trolley backpack. Large padded main compartment ideal for holding a 15" laptop. Two pockets with internal compartments. Front zip pocket. Adjustable padded shoulder straps. Stain resistant wheel cover, shoulder strap storage compartment.

Poliestere 300D | 300D polyester

33,5 x 51 x 21 cm





66080
Pinnig

Zaino trolley 2 ruote con due scomparti principali con zip. Tasca frontale con zip. Manico per il trolley telescopico a scomparsa. Chiusure laterali con fibbie. Convertibile in zaino grazie agli spillacci nascosti nella tasca posteriore. | 2-wheeled trolley backpack with 2 main zippered compartments. Front pocket with zipper closure. Handle for trolley foldable and hidden. Side buckle closures. Convertible to backpack thanks to shoulder straps hidden in the rear pocket.

Poliestere 1680D | 1680D polyester

23 x 50 x 29 cm



66071
Torun

Zaino trolley 2 ruote con due scomparti principali con zip. Tasca frontale con zip. Manico per il trolley telescopico a scomparsa. Convertibile in zaino grazie agli spillacci nascosti nella tasca posteriore. | 2-wheeled Trolley backpack with 2 main zippered compartments. Front pocket with zipper closure. Handle for trolley foldable and hidden. Convertible to backpack thanks to shoulder straps hidden in the rear pocket.

Poliestere | Polyester

50 x 20 x 35 cm



66093
Oumbärlig

Trolley da viaggio due ruote con 5 scomparti con chiusura zip. Uno scomparto imbottito porta computer. Diverse tasche interne e due tasche esterne. Maniglia rinforzata. Manico telescopico. | 2-wheeled trolley with 5 zippered compartments. One compartment is padded to hold laptop. With many pockets inside and 2 pockets in the outside. Reinforced handle. Telescopic handle.

Poliestere | Polyester

23 x 36 x 41 cm



66092
Ordning

Trolley da viaggio 2 ruote con scomparto principale con chiusura zip. Interno imbottito porta computer. Tasca frontale con zip. Manico telescopico estraibile. | 2-wheeled trolley with main compartment with zipper closure. Inside padded compartment for laptop. Front pocket with zip. Telescopic handle.

Poliestere | Polyester

20 x 36 x 41 cm



66024
Mengibinos

Trolley con due ruote, diversi scomparti, uno adatto per il portatile. Perfetto come bagaglio a mano. Manici rinforzati e maniglia telescopica. | Two-wheeled trolley made of polyester 600D with a multitude of compartments, one suitable for laptops. Size for cabin luggage. Reinforced external handles and telescopic handle.

Poliestere 600D | 600D polyester

42 x 19 x 35 cm



66043
Bergama

Trolley porta computer con 2 ruote, ampio scomparto principale con interno imbottito porta computer, due tasche frontali con zip. Maniglia telescopica. Misura bagaglio a mano. | 2-wheeled Trolley with main zippered compartments with padded compartment for laptop. Two front pocket with zipper closure. Handle for trolley foldable and hidden. Hand luggage size.

Poliestere 600D | 600D polyester

42 x 17 x 35 cm





CLASSIC TROLLEY

Made in Europe.



66065
Urbana



Trolley rigido con quattro ruote girevoli e etichetta metallica per la personalizzazione. Dotato di lucchetto integrato. Comparto interno con chiusura elastica. | Rigid trolley with four swivel wheels and metal label for customization. Equipped with integrated padlock. Internal compartment with elastic closure.

Abs | Abs

37,5 x 23 x 49 cm



66064
Susegana



Trolley rigido con quattro ruote girevoli e etichetta metallica per la personalizzazione. Dotato di lucchetto integrato. Comparto interno con chiusura elastica. | Rigid trolley with four swivel wheels and metal label for customization. Equipped with integrated padlock. Internal compartment with elastic closure.

Abs | Abs

37 x 21 x 52,5 cm



66063
Schiavon



Trolley rigido. Due scomparti principali e tasca interna a rete. Chiusura di sicurezza TSA incorporata. | Rigid trolley. Two main compartments and internal mesh pocket. Built-in TSA security lock.

Abs | Abs

36 x 57 x 23 cm



66062
Rosolina



Trolley rigido. Due scomparti principali e tasca interna a rete. Chiusura di sicurezza inclusa. | Rigid trolley. Two main compartments and internal mesh pocket. Safety lock included.

Abs | Abs

34 x 47 x 20 cm





.32



66049
Virgie

Trolley rigido con 4 ruote girevoli. Manico telescopico. | Business trolley in hard rigid ABS material with 4 rotational wheels. Folding handle

Abs | Abs

52 x 35 x 20 cm



.05

.08

.03



66060
Hefei

Trolley, struttura leggera e resistente, maniglia telescopica. Due scomparti interni, uno con chiusura zip e l'altro con cinghie elastiche. Chiusura con combinazione TSA. Misura bagaglio a mano. | Trolley, light and resistant structure, telescopic handle. Two internal compartments, one with zip closure and the other with elastic straps. Closure with TSA combination. Hand luggage size.

Policarbonato, Abs | Polycarbonate, Abs

34 x 54,5 x 23,5 cm



.07

.06

.08

.17

.01

.05

.18

.19

.04

.02



69017
Alp

Targhetta portanome per bagaglio. Con laccetto doppio e cartellino identificativo in inglese e spagnolo. | Trolley case tag. With resistant coupling strap and identification card in Spanish and English.

Plastica | Plastic

5,5 x 9,5 x 0,4 cm



.01



66056
Sommacco

Trolley rigido con tasca portacomputer, manico rinforzato ergonomico per un maggior comfort. Diversi scomparti interni. | Rigid trolley with laptop pocket, reinforced handle

Abs | Abs

35 x 18 x 56 cm



TROLLEY WITH FULLY CUSTOMIZABLE FRONT PANEL



.01



66115
Ayasse

Trolley a quattro ruote con due scomparti interni con chiusura a zip. | Four-wheeled trolley with two internal zipped pockets. Customizable in the front by inserting an encapsulable insert with 4 snap buttons.

Plastica | Plastic

36 x 52 x 18 cm



.23

.01

.19

.08



.02



69002
Hilger

Targhetta portanome per bagaglio. Spazio per dati identificativi sul retro. | Simple and modern style baggage identifier. It has space for writing in its back side.

Plastica, Silicone | Plastic, Silicone

11 x 6 cm



TROLLEY CASE TAG

With resistant coupling strap and identification card.





CORK SUITCASE IDENTIFIER

With card included.



60132
Käresta

Porta documenti da viaggio. Chiusura in velcro, interno foderato, passante per la cintura sul retro. | Travel document bag in resistant polyester. With velcro closure, lined inside and belt accessory at the back.

Poliestere 600D | 600D polyester
27 x 13 cm



60303
Avigliano

Porta documenti con chiusura elastica | Document holder with elastic closure

Cartone | Cardboard
22,5 x 11 cm



NATURAL CORK



69029
Arcugnano

Etichetta identificativa per bagaglio, con cartoncino incluso. | Baggage identification tag with card included.

Sughero | Cork
6 x 11,7 cm



.00



.03 .08 .23



69007
Locke

Portanome per bagaglio | Luggage tag with paper card

Plastica | Plastic
Ø 7,5 x 6,2 x 0,3 cm



.32



69040
Ashley

Targhetta portanome per bagaglio. | Luggage tag.

Alluminio | Aluminum
8 x 4,2 x 0,2 cm





TRAVEL SET

Presented in an individual pouch.

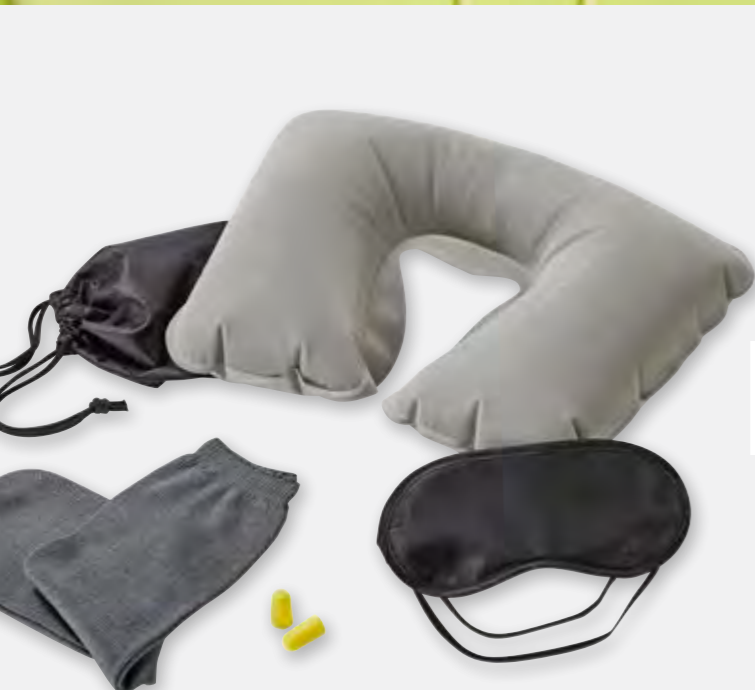

69025 Gubbio

Set viaggio con cuscino poggiatesta, mascherina, tappi per orecchie e calzini. Fornito in pouch singola. | Travel set with neck pillow, sleeping mask, earplugs and socks. Presented in an individual pouch.

Poliestere 190T | 190T polyester

15x20 cm



69015 Yamato

Mascherina per occhi con doppio elastico regolabile | Soft and comfortable mask with double elastic adjustment

Microfibra | Microfiber

18,5 x 9 cm



69026 Heliodor

Set viaggio mascherina e tappi per orecchie. Due tappi per le orecchie. Fornito in custodia singola. | Travel set of mask and earplugs. Mask in microfiber with elastic adjustment. Pair of earplugs in EVA material. Presented in an individual bag.

Microfibra, Eva | Microfibre, Eva

19 x 9 cm



69027 Arcade

Mascherina per gli occhi morbida e confortevole | Soft and comfortable eye mask

Raso | Satin

Mask: 20 x 10 cm / Elastic: 26,5 cm

NEW



69008 Rhys

Cuscino da viaggio gonfiabile | Inflatable neck pillow in soft microfiber

Microfibra | Microfiber

41 x 25 x 0,2 cm



69000 Puppys

Cuscino da viaggio gonfiabile | Inflatable neck pillow in soft microfiber

Microfibra | Microfiber

33 x 25 x 9 cm



.06



69048
Merrit

Tappi per orecchie forniti in confezione singola. | Earplugs presented in an individual case.

Eva, Pvc | Eva, Pvc

3,5 x 3,5 x 1,5 cm



COTTON BAG FOR SHOES

.13



64319
Arcole

Sacca in cotone. Chiusura con coulisse, perfetta per le scarpe | Cotton bag. Draw-string closure, perfect for shoes

Cotone - 120 gr/m2 | Cotton - 120 gr/m2

42 x 34 cm



.05

.04

.01

.23



.08



64325
Riese

Borsa porta scarpe. Dotata di pratica maniglia per il trasporto. | Shoe bag. Equipped with a practical carrying handle.

Poliestere 600D | 600D polyester

35 x 15 cm



43131
Galliera

Calza scarpe | Shoehorn

Plastica | Plastic

25 x 4,3 x 0,5 cm

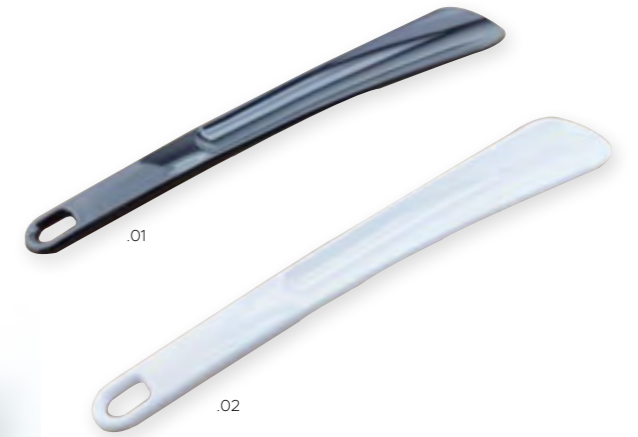

.01

.02



.17

.06

.23

.04

.08



69030
Villadose

Tappi per le orecchie. Forniti in custodia con catenella. | Earplugs. Supplied in case with chain.

Eva | Eve

6,4 x 2,2 cm



42059
Sandrigo

Kit per la pulizia delle scarpe, comprende un calzascarpe, un panno per la pulizia, 2 spazzole e un lucidante neutro. Fornito in confezione di metallo. | Shoe cleaning kit, includes a shoehorn, cleaning cloth, 2 brushes and a neutral polish. Supplied in metal packaging.

Metallo | Metal

14 x 4,7 cm



.32





72005
Tucson

Bilancia digitale pesa bagagli, pesata massima 40KG. | Digital luggage scale. Maximum weight of 40kg.

Plastica | Plastic
10 x 18 x 3,7 cm



43072
Hilmi

Adattatore per presa da parete, include adattatori per USA, Europa, Asia e Regno Unito. | adapter plugs including multi-region adapters for the USA, Europe, Asia and the United Kingdom.

Plastica | Plastic
Ø 4,5 x 8,5 cm



26401
Gattatico

Adattatore da viaggio perfetto per ogni tipo di presa. Dotato anche di un ingresso USB da 6.0A. Fornito in custodia | Travel adapter for all types of inputs. It has an usb input with 6,0 A of power. Presented in box made of the same material.

Plastica | Plastic
9 x 4,5 x 6 cm



26182
Branford

Adattatore per prese da viaggio, con diversi adattatori per ogni tipo di ingresso. Fornito in scatola singola in plastica. | Travel adapter with several adapters for every input type. Presented within a box in the same material.

Plastica | Plastic
6 x 6 x 5 cm



69102
Nichelino

Lucchetto con combinazione numerica. | Metallic security padlock with numerical combination.

Metallo | Metal
2 x 6,5 x 0,8 cm



43109
Vihti

Kit viaggio che comprende 2 flaconcini da 65ml e 1 da 60ml, un vaporizzatore da 80ml e un mini imbuto. Forniti all'interno di una pouch in PVC trasparente | Airtight cosmetic bag with 3 jars (2 x 65 ml and 60 ml), 1 vaporizer (80 ml) and 1 mini funnel. Presented in a PVC transparent pouch with zip-top.

Pvc | pvc
19 x 15,5 x 4 cm



43170
Gianni

Adattatore universale da viaggio. Europa, Asia, Regno Unito, USA, Australia. 2 uscite USB. Velocità di ricarica 2100 mAh. | Universal travel adapter. With matte finish and soft touch. Europe, Asia, United Kingdom, USA, Australia.

Plastica | Plastic
6,1 x 4,5 x 5,6 cm



43057
Riquis

Adattatore universale di prese da parete, include adattatori per USA, Europa, Asia e Regno Unito. | Retractable plug adapter, including multi-region adapters for the USA, Europe, Asia and the United Kingdom.

Plastica | Plastic
5 x 7,4 x 4 cm



Shopping

and

Bags

Shopping and Bags

Borse per la spesa, borse porta pizza, borse da spiaggia in una vasta gamma di materiali e tessuti. Borse pieghevoli e trolley per la spesa.

Shopping bags, pizza carrier bags, beach bags in a great range of materials and fabrics. Foldable bags and shopping trolleys.



SHOPPING BAGS

Bags made of non-woven with reinforced handles.



 17326
Masala

Borsa con finiture termosaldate, manici lunghi e soffietto esagonale alla base. | Heat-sealed bag with long handles and hexagonal gusset at base.

TNT No-woven - 80gr/m2 | TNT No-woven - 80gr/m2
54 x 40 cm

80 gr/m²



 17327
Meitnerio

Borsa con finiture termosaldate, soffietto laterale, manici corti coordinati. | Heat-sealed bag with expansion in the sides and base. Matching handles.

TNT No-woven | TNT No-woven
35 x 40 x 12 cm - Handles 24 cm

100 gr/m²

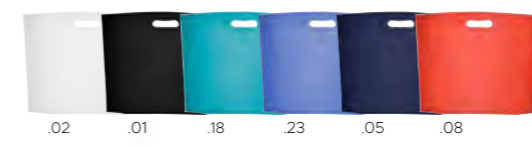

 17325
Manganese

Borsa con finiture termosaldate con manico fustellato | Heat-sealed bag with handle integrated in the body.

TNT No-woven - 80gr/m2 | TNT No-woven - 80gr/m2
40 x 30cm

80 gr/m²

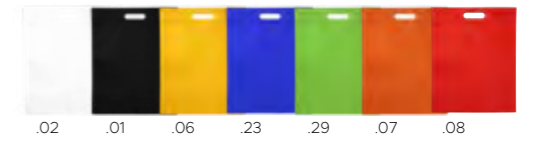

 17022
Sneld

Borsa con manici fustellati rinforzati e finiture termosaldate. | Bag with reinforced die-cut handles and heat-sealed finish.

TNT No-woven - 80gr/m2 | TNT No-woven - 80gr/m2
34 x 44 cm

80 gr/m²



 17184
Sedlig

Borsa shopper con tasca frontale aperta. Manici lunghi bianchi, piping bianco sulla tasca frontale, finiture cucite. | Shopping bag with open front pocket. Long white handles, white piping on the front pocket, stitched finishing.

TNT No-woven - 80gr/m2 | TNT No-woven - 80gr/m2
41 x 37,5 cm

80 gr/m²



.01 .23



17076
Class

Borsa shopper. Ampio scomparto principale, manici lunghi rinforzati e soffiati. Finiture cucite. | Shopping bag. Large main compartment, with long reinforced handle and gussets. Stitched finishing.

TNT No-woven - 80gr/m2 | TNT No-woven - 80gr/m2

38 x 33,5 x 10 cm

80 gr/m²



.07 .18 .19



17053
Arbo

Borsa shopper con manici corti rinforzati, soffiati e finiture cucite. | Shopping bag with short reinforced handles, gussets and stitched finishing.

TNT No-woven | TNT No-woven

40 x 35 x 7 cm

80 gr/m²



.02 .10 .13 .17 .15 .07 .01 .04 .19 .08 .23



17030
Siggo

Borsa con chiusura con zip, soffiati, manici medi lunghezza circa 45cm, finiture cucite. | Non-woven bag in 90g/m2 in a varied range of bright tones. With zipper closure, gussets, 45cm medium handles and stitched finishing. Resistance up to 6kg of weight.

TNT No-woven | TNT No-woven

50 x 11 x 41 cm

80 gr/m²



.02 .07 .08 .23 .06 .13 .01 .04



17146
Adele

Borsa in tnt laminato con finitura lucida, manici rinforzati. Finiture cucite, soffiati e piping rinforzati. | Bag in non-woven with lamination material and shiny finishing. Reinforced handles. Stitching finishing, with reinforced gussets and piping.

PP - 100gr/m2 | PP - 100gr/m2

40 x 35 x 13 cm

100 gr/m²



.08 .02 .23 .05 .19



17080
Thora

Borsa shopper misura media, manici corti rinforzati e soffiati. Finiture cucite. | Shopping bag medium size, with short reinforced handle and gussets. Stitched finishing.

TNT No-woven | TNT No-woven

20 x 25 x 7 cm

80 gr/m²



.02 .01 .17 .07 .06 .08 .04 .23



17107
Nanda

Borsa con manici corti rinforzati, finiture termosaldate. | Bag with reinforced, short handles and heat-sealing finish.

TNT No-woven | TNT No-woven

38x35cm

80 gr/m²



.08 .06 .13 .19



17013
Lies

Borsa shopping con ampio scomparti principale. Manici medi rinforzati. Finiture cucite. | Non-woven shopping bag with large main compartment. Medium length reinforced handles. Stitched finishing.

TNT No-woven | TNT No-woven

40 x 34 x 20 cm

100 gr/m²



.08 .02 .01 .04 .07 .23



17229
Albanese

Borsa shopper con manici lunghi rinforzati. Finiture cucite. | Shopping bag with long reinforced handles. With stitched finishing.

TNT No-woven - 80gr/m2 | TNT No-woven - 80gr/m2

33 x 38 x 25 cm

80 gr/m²



54016
Necocarpo

Borsa con manici rinforzati da 53cm, soffietti rinforzati con piping e finiture cucite. | Bag with reinforced handles of 53cm, reinforced gussets with piping and stitched finish.

TNT No-woven | TNT No-woven

38 x 40 x 8 cm

90
gr/m²



54011
Hajo

Borsa shopping, design bicolore. Manici lunghi rinforzati, soffietti e finiture cucite. | Shopping bag with bicolour design. Long reinforced handles, gussets and stitched finishing.

TNT No-woven | TNT No-woven

40 x 35,5 x 13 cm

80
gr/m²



64155
Pasu

Borsa shopper, ampio scomparto principale, manici lunghi, finiture termosaldate. | Shopping bag, large main compartment, long handles, heat-sealed finishes.

No-woven | No-woven

40 x 36 cm

80
gr/m²



HEAT-SEALED

.06



17098
Minna

Borsa di colore bianco con manici colorati. Manici lunghi rinforzati e finiture termosaldate. | Bag, in combination of white body with handles in varied bright tones. Long reinforced handles with eco logo and heat-sealed finish.

TNT No-woven | TNT No-woven

33 x 41,5 cm

75
gr/m²



SEWING



17074
Linn

Borsa con manici lunghi. Finiture cucite. | Bag with long handles. Stitched finishing.

TNT No-woven | TNT No-woven

37 x 42 cm

80
gr/m²

SET OF 3 RECYCLING BAGS

With reinforced handles.



17312
Hassio



Set borse per la raccolta differenziata, composto da 3 borse (vetro, plastica e carta) | Set of 3 RPET recycling for different types of basic waste (Glass, plastic and paper).

TNT No-woven RPET - 110 gr/m² | TNT No-woven RPET - 110 gr/m²

23,5 x 24 x 127,5 cm

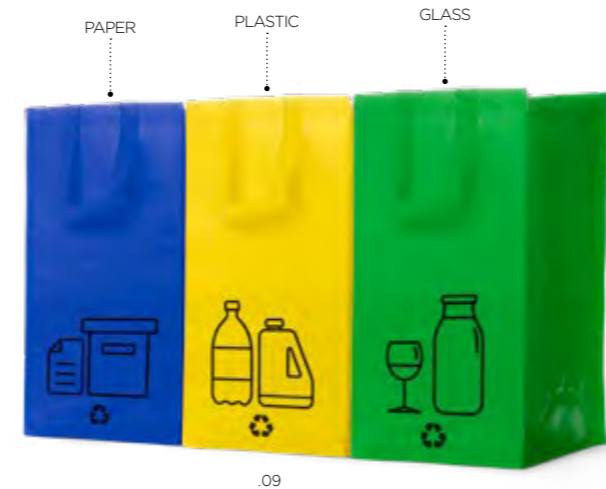

17302
Melocactus

Set di 3 sacchetti per la raccolta differenziata realizzati in resistente tessuto pp laminato opaco con velcro laterale e manici rinforzati. | Set of 3 bags for separate waste collection made of resistant opaque laminated pp fabric with lateral velcro and reinforced handles.

PP laminato | laminated PP

99 x 84 x 132 cm



17135
Hupp

Borsa tracolla con scomparto principale aperto. Chiusura con patella con velcro. Tracolla. | Shoulder bag with open main compartment. Flap with velcro closure and shoulder strap.

TNT No-woven | TNT No-woven

26 x 33 x 6 cm



17015
Janna

Borsa tracolla dal design bicolore, tracolla confortevole | Big size shoulder bag, with bicour design.

TNT No-woven | TNT No-woven

37 x 30 x 9 cm



17056
Dolf

Shopper pieghevole, manici corti rinforzati, finiture cucite. Dimensioni ridotte quando ripiegata. Chiusura con bottone. | Foldable bag, with short reinforced handles (35cm), stitched finishing. Small sized when folded. With snap button closure.

TNT No-woven | TNT No-woven

35 x 41 x 10 cm





54020
Wip

Borsa in TNT laminato con finitura metallizzata. Manici rinforzati misura 55cm, soffiotti e finiture cucite. | Laminated non-woven bag with metallic finish. With reinforced, medium size 55cm handles, gussets and stitched finishing.

TNT No-woven Laminato | Non-Woven Laminato

42 x 35 x 12 cm

110
gr/m²



54040
Marina

Borsa shopper con tasca frontale aperta. Manici lunghi rinforzati, soffiotti e finiture cucite. | Shopping bag with open pocket on front. Long reinforced handles, gussets and stitched finishing.

Feltro | Felt

38 x 28 x 14 cm



64030
Fons

Borsa con ampio scomparto principale, manici lunghi, finiture cucite | Shopping bag, large main compartment, long handles, stitched finishes

Poliestere 190T | 190T polyester

38 x 42 cm

75
gr/m²



17323
Magnesio

Borsa shopper riutilizzabile con finitura laminata lucida. Materiale resistente con manici neri in nylon rinforzato e bordature nere abbinata. | Reusable bag with glossy laminated finish. Durable material with reinforced nylon handles and matching black piping.

PP laminato - 120gr/m² | Laminated PP - 120gr/m²

30 x 12 x 40 cm

120
gr/m²

FELT FABRIC



.13 .23 .04



17205
Volla



Borsa pieghevole, chiusura in velcro, finiture cucite. Manici lunghi. Dimensioni ridotte quando ripiegata. | Folding bag, with velcro closure and stitched finishing. Long handles. Small size folding.

Cotone - 140 gr/m2 | Cotton - 140 gr/m2

35 x 39 cm

140 gr/m²

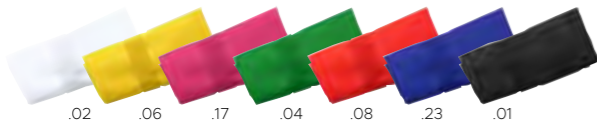

.02 .06 .17 .04 .08 .23 .01



.07



17810
Lara

Borsa della spesa pieghevole, finiture cucite. Include pratico elastico per piegatura. | Folding shopping bag with stitched finish. Includes practical elastic for folding

Poliestere 190T | 190T polyester

42,5 x 7 x 38 cm



.02 .01 .04 .23 .07 .08



17045
Taleon

Borsa pieghevole. Manici corti, chiusura in velcro coordinata e finiture cucite. | Folding bag in a varied range of bright tones. With short handles, matching colour velcro closure and stitched finishing.

TNT No-woven - 80gr/m2 | TNT No-woven - 80gr/m2

38 x 42 cm

80 gr/m²



.01 .05 .02



.08 .29



.18



17196
Violetto

Borsa pieghevole con manici corti. Ripiegabile nell'angolo | Folding bag with handles integrated in the shape of the bag. Foldable in the corner.

Poliestere 210D | 210D polyester

35 x 54 cm

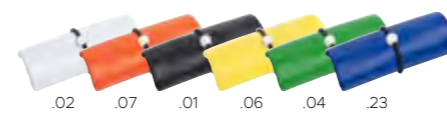

.02 .07 .01 .06 .04 .23



.08



17175
Gioiosa

Borsa pieghevole. Laccetto di chiusura elastico e finiture cucite. | Folding bag in fun and varied colours. Elastic folding band and stitched finishing.

Poliestere 190T | 190T polyester

38 x 42 cm



.08 .06



.01



.23



64032
Alf

Borsa shopper pieghevole con scomparto principale aperto, manici corti rinforzati, ripiegabile a forma di orsetto con chiusura zip. | Foldable shopping bag with open main compartment, short reinforced handles, foldable in a bear shape with zipper closure.

Poliestere Laminato | Laminated polyester

38 x 42 cm Open/26 x 15 cm Close

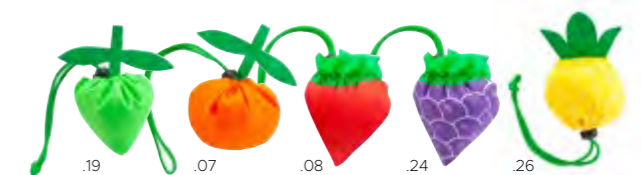

.19 .07 .08 .24 .26



.11



.04

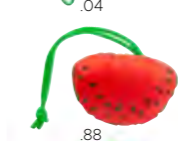

.88



.06



17051
Anja

Borsa pieghevole a forma di frutto, con coulisse coordinata e ferma coulisse. | Folding bag of fun fruity designs in bright tones. Made of soft 190T polyester.

Poliestere 190T | 190T polyester

38 x 40 cm



.13



17512 **Montale**

Borsa con manici corti rinforzati e soffiati. | Bag with reinforced short handles and gussets.

Carta - 100gr/m2 | Paper - 100gr/m2

41 x 36 x 10 cm

100 gr/m²



17352 **Munsbit**
17505 **Munsbit Colors**

Borsa con manici corti rinforzati e soffiati. | Bag with reinforced short handles and gussets.

Carta - 100gr/m2 | Paper - 100gr/m2

22 x 23 x 9 cm

100 gr/m²



.13



17353 **Tosca**
17507 **Tosca Colors**

Borsa con manici corti rinforzati e soffiati. | Bag with reinforced short handles and gussets.

Carta - 100gr/m2 | Paper - 100gr/m2

25 x 31 x 11 cm

100 gr/m²



17322 **Maggiorana**

Borsa in carta color avana. Manici corti piatti rinforzati. Ideale per il settore alimentare (take away) | Paper shopper in natural finish. Reinforced flat short handles. Ideal for hotels and restaurants (take away).

Carta - 80 gr/m2 | Paper - 80 gr/m2

30 x 18 x 29 cm

80 gr/m²



.13



.13



17354 **Norråker**
17508 **Norråker Colors**

Borsa con manici corti rinforzati e soffiati. | Bag with reinforced short handles and gussets.

Carta - 100gr/m2 | Paper - 100gr/m2

41 x 32 x 12 cm

100 gr/m²



.13



17355 **Nockeby**
17509 **Nockeby Colors**

Borsa con manici corti rinforzati e soffiati. | Bag with reinforced short handles and gussets.

Carta - 100gr/m2 | Paper - 100gr/m2

32 x 40 x 12 cm

100 gr/m²



.13



17266 **Lavanda**

Sacchetto di carta kraft con due manici in cotone da 64 cm | Tote bag made of kraft paper with two 64 cm. long cotton handles

Carta kraft, Polietilene, TNT Non-Woven | Kraft paper, Polyethylene, Non-Woven TNT

32 x 37,5 cm

80 gr/m²





2MM POLYESTER FELT

.03



54044
Angelica



Borsa in feltro, ampio scomparto principale, manici lunghi in similpelle, finiture cucite. | Shopping bag made of felt, large main compartment, synthetic leather long handle, stitched finishing.

Poliestere RPET 2mm, similpelle | Polyester RPET 2mm, imitation leather

46 x 8 x 33 cm



2MM POLYESTER FELT

.03



54038
Androsace



Borsa in feltro, ampio scomparto principale, manici lunghi, finiture cucite. | Shopping bag made of felt, large main compartment, long handle, stitched finishing.

Poliestere RPET 2mm | Polyester RPET 2mm

42 x 11,5 x 31 cm

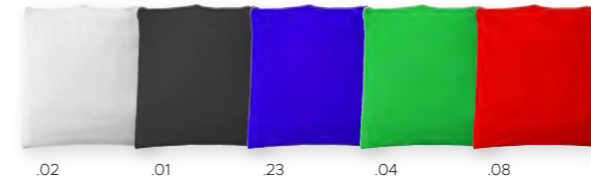

17244
Dolly



Borsa shopper pieghevole. Include una pratica tasca per la sua piegatura. | Foldable shopping bag made from soft recycled RPET polyester. Practical pocket for folding included.

Poliestere riciclato 190T RPET | 190T RPET recycled polyester

33 x 8 x 46 cm



17063
Cleta



Borsa shopper con manici lunghi rinforzati. Finiture cucite. | Shopping bag in RPET with long reinforced handles. Stitched finishing.

RPET Laminato | RPET Laminate

37 x 41 x cm

100 gr/m²



17315
Creepy



Borsa con finitura opaca, manici lunghezza media e cuciture e base rinforzate. Con etichetta RPET. | Bag with matt finishing, medium size handles and reinforced stitching and base. With RPET distinctive label.

RPET Laminato - 100gr/m² | RPET Laminate - 100gr/m²

42 x 35 x 15 cm

100 gr/m²



FAIRTRADE COTTON BAGS

With long handles.



.13



.13



17292
Pungitopo



Borsa in cotone Fairtrade, con manici lunghi. | Bag made of fair trade cotton, with long handles.

Cotone Fairtrade | Fairtrade cotton

38 x 42 cm



17289
Petunia Surfinia



Borsa prodotta in Europa. Può essere fatto con 3 tipi di cotone: OEKO TEX, riciclato o equosolidale. | Bag manufactured in Europe. Produced with Fairtrade cotton.

Cotone Fairtrade - 320 gr/m² | Fairtrade cotton - 320 gr/m²

38 x 42 cm



.13



64309
Sichuan



Sacca shopper 2 in 1 con chiusura con coulisse e manici lunghi. | 2 in 1 shopping bag with drawstring closure and long handles.

Cotone Fairtrade - 140 gr/m² | Fairtrade cotton - 140 gr/m²

38 x 46 cm



17291
Potos



Borsa in cotone Fairtrade, resistente e facile da trasportare, con manici lunghi. | Bag made of fair trade cotton, with long handles.

Cotone Fairtrade | Fairtrade cotton

38 x 40 x 9 cm



.13



FAIR TRADE COTTON

Fair trade is a global movement made up of a diverse network of producers, companies, consumers, advocates, and organizations putting people and planet first.

Fair trade is a way to make a conscious choice for a better world. A choice for Fair Trade Certified™ goods is a choice to support responsible companies, empower farmers, workers, and fishermen and protect the environment.



17362
Benaco



Shopper manici da 70 cm, finiture cucite, ampio scomparto principale. 180 g/m² | Shopper with 70 cm handles, stitched finish, large main compartment. 180 g/m²

Cotone Fairtrade | Fairtrade cotton

37 x 41 cm

180 g/m²



17366
Berici



Shopper manici da 70 cm, finiture cucite, ampio scomparto principale. 180 gr/m² | Shopper with 70 cm handles, stitched finish, large main compartment. 180 gr/m²

Cotone Fairtrade | Fairtrade cotton

37 x 41 cm

180 g/m²



.13



.08

.04

.02

.01

.23



17382
Sona



Borsa shopper con manici rinforzati lunghi 70 cm. | Shopper bag with 70 cm long reinforced handles.

Cotone Fairtrade - 180 g/m² | Fairtrade Cotton - 180 gr/m²

38 cm

180 g/m²



17384
Verona



Borsa shopper colorata con manici rinforzati lunghi 70 cm. | Colored shopper bag with 70 cm long reinforced handles.

Cotone Fairtrade - 180 g/m² | Fairtrade Cotton - 180 gr/m²

38 x 42 cm

180 g/m²



140 GR/M²
50 X 38 X 15 CM

POCKET INSIDE

RECYCLED COTTON

Global Recycled Standard

54066
Roncà

NEW ECO

Borsa mare color natural, ampio scomparto principale, tasca frontale aperta. Manici lunghi rinforzati. | Beach bag in natural color, large main compartment, open front pocket. Reinforced long handles.

Cotone riciclato - 140gr/m2 | Recycled cotton - 140gr/m2

50 x 38 x 15 cm

140 gr/m²

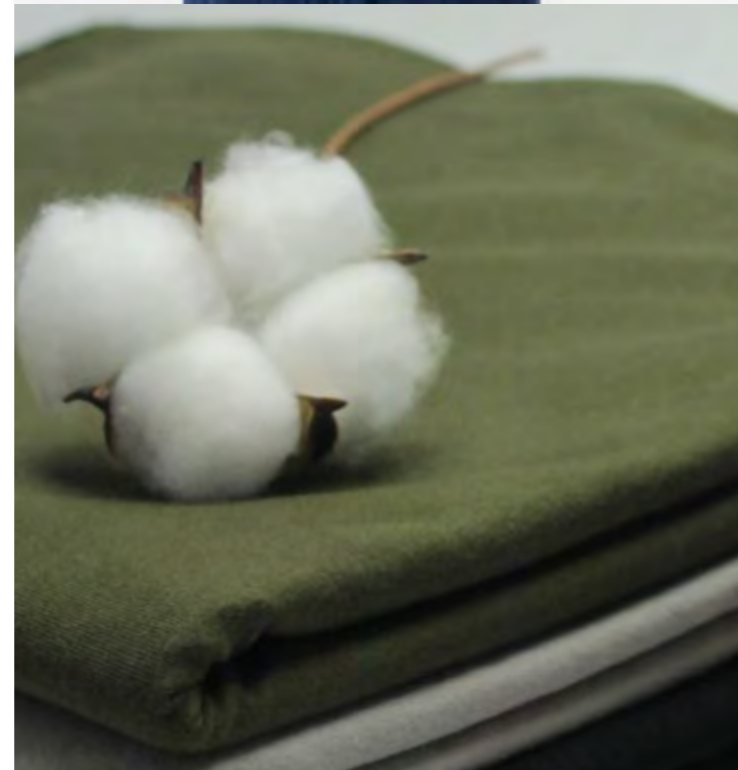

140 GR/M²
50 X 38 X 15 CM

POCKET INSIDE

RECYCLED COTTON

Global Recycled Standard

54065
Ponzano

NEW ECO

Borsa mare finitura solida, ampio scomparto principale, tasca frontale aperta. Manici lunghi rinforzati. | Beach bag in solid finish, large main compartment, open front pocket. Reinforced long handles.

Cotone riciclato - 140gr/m2 | Recycled cotton - 140gr/m2

38 x 42 cm

140 gr/m²



140 GR/M²
38 X 41 X 8,5 CM

RECYCLED COTTON

Global Recycled Standard

17238
Sentinella

ECO

Borsa shopper manici lunghi. | Long handles tote bag

Cotone riciclato - 140 gr/m2 | Recycled cotton - 140 gr/m2

37 x 41 cm

140 gr/m²



RECYCLED COTTON

Global Recycled Standard

17367
Boschi

NEW ECO

Borsa con finitura mélange, ampio scomparto principale, soffietto e manici lunghi da 70cm | Bag with mélange finish, large main compartment, gusset and 70cm long handles

Cotone riciclato - 140 gr/m2 | Recycled cotton - 140 gr/m2

38 x 41 x 8,5 cm

140 gr/m²



140 GR/M²
37 X 41 CM

RECYCLED COTTON

Global Recycled Standard

17238
Sentinella

ECO

Borsa shopper manici lunghi. | Long handles tote bag

Cotone riciclato - 140 gr/m2 | Recycled cotton - 140 gr/m2

37 x 41 cm

140 gr/m²



140 GR/M²
38 X 42 CM

RECYCLED COTTON

Global Recycled Standard

17301
Calla di palude

ECO

Borsa shopper in cotone riciclato, con manici lunghi, finiture cucite. | Long handle bag made of recycled cotton, stitched finishing.

Cotone riciclato | Recycled cotton

42 x 38 cm

140 gr/m²



.19 .01 .08 .23 .13



.01 .23 .08

120 GR/M²

38 X 42 CM



120 GR/M²

38 X 42 CM

RECYCLED COTTON

RECYCLED COTTON



17214 **Diosa**



Borsa shopper con manici lunghi. Finiture cucite. | Shopping bag with long handles. Stitched finishing.

100% Cotone Riciclato - 120 gr/m² | 100% Recycled Cotton - 120 gr/m²

38 x 42 cm

120 gr/m²



17376 **Malcesine**



Borsa shopper con finitura mélange. Manici rinforzati lunghi 70 cm. | Shopper bag with mélange finish. Reinforced handles 70 cm long.

Cotone riciclato, Cotone naturale - 120 g/m² | Recycled cotton, Natural cotton - 120 gr/m²

38 x 42 cm

120 gr/m²



.00

RECYCLED COTTON



JUTE

RECYCLED COTTON



JUTE



.01



.23



.08



17299

Berretta



Borsa in cotone riciclato, con base in juta e manici lunghi. | Bag made of recycled cotton, with jute base and long handles.

Cotone Riciclato, Jute | Recycled Cotton, Jute

44 x 38 x 18 cm

230 gr/m²



17377

Montecchia



Borsa shopper con finitura mélange. Manici rinforzati lunghi 70 cm. | Shopper bag with mélange finish. Reinforced handles 70 cm long.

Cotone riciclato, Cotone naturale - 120 g/m² | Recycled cotton, Natural cotton - 120 gr/m²

38 x 41 cm

120 gr/m²

250 GR/M²

45 X 38 X 10 CM



RECYCLED COTTON



.13



17356

Bovolenta



Borsa con ampio scomparto principale con tasca interna, manici lunghi da 65cm. | Bag with large main compartment with internal pocket, 65cm long handles.

Cotone riciclato | Recycled cotton

45 x 38 x 10 cm

250 gr/m²

280 GR/M²

38 X 42 CM



RECYCLED COTTON



.13



17288

Pervinca



Borsa prodotta in Europa. Realizzata in cotone riciclato. | Bag manufactured in Europe. Produced with recycled cotton

Cotone riciclato - 280 gr/m² | Recycled cotton - 280 gr/m²

38 x 42 cm

280 gr/m²

200
GR/M²

38 X 42 X 8 CM



17176
Gavoi

Borsa con manici lunghi, soffiotti e finiture cucite. | Bag with long handles, gussets and stitched finishing.

100% Cotone - 200gr/m² | 100% Cotton - 200gr/m²

38 x 42 x 8 cm

200
gr/m²

140
GR/M²

38 X 42 CM



17021
Raimo

Borsa shopper nera con manici lunghi colorati rinforzati. | Shopping bag in black color, with long reinforced coloured handles.

Cotone | Cotton

38 x 42 cm

120
gr/m²



RECYCLED COTTON



140
GR/M²

38 X 42 CM



17494
Grappa

Borsa shopper ampio scomparto principale, manici lunghi rinforzati. | Shopping bag large main compartment, long reinforced handles.

Cotone riciclato - 140gr/m² | Recycled cotton - 140gr/m²

38 x 42 cm

140
gr/m²



17513
Monteforte

Borsa shopper ampio scomparto principale, manici lunghi rinforzati. Finitura solida. | Shopper bag with large main compartment, long reinforced handles. Solid finish.

Cotone riciclato - 140gr/m² | Recycled cotton - 140gr/m²

38 x 42 cm

140
gr/m²





RECYCLED COTTON



64233
Noir



Shopper trasformabile in sacca- zaino in resistente cotone riciclato, con manici abbinati. Coulisse in cotone grezzo, con anelli metallici di rinforzo ed etichetta materiale in cotone riciclato. | Shopping bag/drawstring backpack, made recycled cotton, with matching carry handles. Strings in natural cotton, with reinforced metal rings and recycled cotton distinctive in the label.

100% Cotone Riciclato - 140 g/ m2 | 100% Recycled Cotton - 140 g/ m2

38 x 42 cm

140 gr/m²



.05



17393
Sarmede



Borsa shopper con manici lunghi. Ampio scomparto principale. | Shopper bag with long handles. Large main compartment.

Cotone, Denim riciclato - 250 gr/m2 | Cotton, Recycled Denim - 250 gr/m2

40 x 42 cm

250 gr/m²



.01

180 GR/M²

50 X 37 CM



180 GR/M²

50 X 37 CM



.13



17373
Bovolone



Borsa shopper con chiusura a coulisse | Shopper bag with drawstring closure

Cotone | Cotton

53 x 37 cm

180 gr/m²



17372
Breganze



Borsa shopper con chiusura con coulisse | Shopper bag with drawstring closure

Cotone Organico | Organic Cotton

53 x 37 cm

180 gr/m²



RECYCLED DENIM



1000% HEMP FABRIC



.01 .23 .04

100% HEMP FABRIC



17378
Orgiano



Borsa shopper. Manici rinforzati lunghi 70 cm. | Shopper bag. Reinforced handles 70 cm long.

Canapa - 200 gr/m2 | Hemp - 200 gr/m2

38 x 42 x 10 cm

200 gr/m²



.01 .23 .04

100% HEMP FABRIC



17379
Pisani



Borsa shopper. Manici rinforzati lunghi 70 cm. | Shopper bag. Reinforced handles 70 cm long.

Canapa - 200 gr/m2 | Hemp - 200 gr/m2

38 x 42 cm

200 gr/m²



.01 .06 .23 .08 .19



17381
Salcedo



Borsa shopper, con manici rinforzati lunghi 70 cm. | Shopper bag, with reinforced handles 70 cm long.

Cotone Organico - 140 gr/m2 | Organic Cotton - 140 gr/m2

38 x 42 cm

140 gr/m²



.13



17225
Garhwal



Borsa con manici lunghi. Ampio scomparto principale. Finiture cucite. | Bag with long handles. Large main compartment. Stitched finishing.

Cotone Organico | Organic Cotton

38 x 8 x 40 cm

180 gr/m²



.16 .01 .23 .04



17337
Nigrum



Borsa shopper con ampio scomparto principale, manici lunghi, finiture cucite, etichetta sul lato | Shopping bag with large main compartment, long handles, stitched finishing, label on the side.

Cotone Organico - 140 gr/m2 | Organic Cotton - 140 gr/m2

38 x 41,5 cm

140 gr/m²



.13



17497
Jackie



Borsa shopper, manici lunghi e taschina interna. Finiture cucite. | Shopping bag with long handles and inner pocket. Stitched finishing.

Cotone - 280 gr/m2 | Cotton - 280 gr/m2

45 x 10,5 x 38 cm

280 gr/m²

BAGS WITH LONG HANDLES

Made in organic cotton.



.13



17321
Siena



Borsa shopper con manici lunghi 70cm. | Shopper 100% organic cotton with reinforced handles 70cm long.

100% Cotone Organico - 120 gr/m2 | 100% Organic Cotton - 120 gr/m2

38x42cm

120 gr/m²



.00



17310
Andromeda



Shopper con soffierto e manici corti rinforzati. | Shopping bag with gusset and reinforced short handles.

Cotone Organico | Organic Cotton

40 x 10 x 40 cm

120 gr/m²



.13



17496
Jakobstad



Borsa shopper con manici lunghi | Bag with long handles

100% Cotone Organico - 230 gr/m2 | 100% Organic Cotton - 230 gr/m2

35 x 40 x 12 cm

230 gr/m²



.13



17332
Molibdeno



Borsa shopper con soffierto e manici lunghi 70cm | Bag with bellows and practical handles

100% cotone biologico - 280 gr/m2 | 100% organic cotton - 280 gr/m2

38 x 42 x 9 cm

280 gr/m²



.13



17331
Mitmita



Borsa shopper con manici lunghi 70cm. | Bag with practical handles.

100% Cotone Organico - 300 gr/m2 | 100% Organic Cotton - 300 gr/m2

40 x 40 cm

300 gr/m²



17485
Isokyrö



Borsa shopper con manici lunghi | Bag with long handles

100% Cotone Organico - 105 gr/m2 | 100% Organic Cotton - 105 gr/m2

38 x 42 cm

105 gr/m²

YOUR BESPOKE PAPER BAGS



YOUR BESPOKE SHOPPER BAGS



1

Seleziona il materiale e la grammatura della tua borsa

Select the material and thickness of your bag

2

Scegli i manici, il loro colore e il materiale più adatto!

Select the handles size, colour and material based on your needs

3

Applica il tuo logo in base alle tue esigenze...

Place your logo as you like

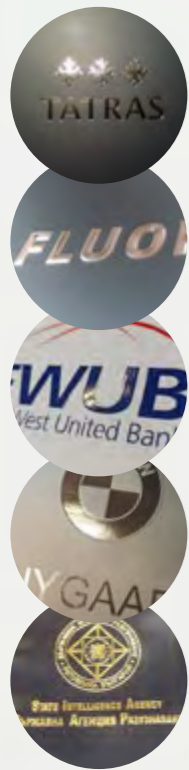

bespoke
expert in special productions

MADE IN ITALY MADE IN EU MADE IN ASIA



Scegli il tessuto che preferisci ...

Cotone, Rpet, Poliestere, Lana, Nylon, Tnt ecc...

Select the fabric you need...

Cotton, Rpet, Polyester, Wool, Non-woven, Nylon etc...



Scegli il colore della tua borsa e personalizzala!

Choose your bag colors and customize it!



bespoke
expert in special productions



.13



17804
Ribuelos



Borsa con tasca frontale. Manici corti rinforzati, in cotone bianco. Soffiети, finiture cucite, resistente a un carico di max 10kg. | Bag with cotton front pocket. With short, reinforced cotton handles in white colour. With gussets, stitched finishing and resistance up to 10kg weight.

Juta, Cotone | Jute, Cotton

44,5 x 34 x 15 cm



.13



17805
Brogrund



Borsa con tasca frontale in cotone. Manici lunghi rinforzati, in cotone bianco. Soffiети, finiture cucite. | Bag with cotton front pocket. With long, reinforced cotton handles in white. With gussets and in stitched finishing.

Juta, Cotone | Jute, Cotton

48 x 35 x 15 cm



.04

.13

.08

.05



17999
Saluzzo



Borsa con laminazione fronte e retro, soffiети in juta, con interno laminato. Manici lunghi in cotone. Finiture cucite. | Bag made of cotton laminated in its front and back sides, and jute gussets with lamination of the inside part, with long cotton handles. Stitched finishing.

Cotone - 230 gr/m2, Juta | Cotton - 230 gr/m2, Jute

39 x 16 x 31,5 cm

230 gr/m²



COTTON

JUTE

COTTON

JUTE

.13



17850
Boissano



Borsa eco-friendly finiture cucite. Manici lunghi rinforzati, da 70cm. | Eco-friendly bag in a resistant combination of natural materials -jute and cotton- of 245gr/m2 and stitched finishing. 70cm, reinforced, long handles

Juta, Cotone | Jute, Cotton

37 x 41 cm

245 gr/m²



COTTON

JUTE

.13



17247
Donatello



Borsa pieghevole 100% cotone 110 g/m2 e pochette in juta | Folding bag with jute base, with pocket, stitched finish and resistance up to 8 kg weight. Small size folding in the jute base with zipper closure.

100% Cotone - 110gr/m2, Juta | 100% Cotton - 110gr/m2, Jute

34,5 x 39 x 10 cm

110 gr/m²





.01



17357
Borca

Borsa con manici rinforzati, da 50cm. Perfetta per la spiaggia o per lo shopping. Con laminazione interna per maggiore resistenza. | Bag with reinforced handles, 50 cm. Perfect for the beach or shopping. With internal lamination for added strength.

Juta laminata | Laminated jute

44 x 33,5 x 15 cm

330
gr/m²



.13



17374
Bonifacio

Borsa shopper in colore neutro con manici in cotone da 50cm. Ampio scomparto principale, con soffietto. | Shopper bag in neutral color with 50cm cotton handles. Large main compartment, with gusset.

Juta, cotone - 250 gr/m² | Jute, cotton - 250 gr/m²

45 x 40 x 17 cm

250
gr/m²



.01 .02 .17 .08 .07 .06 .23 .04



.13



17026
Jenni

Borsa ecologica con corpo color natural e manici verdi di lunghezza media. Finiture cucite. | Ecological jute bag with body in natural colour and medium handles of 52cm in green colour.

Juta | Jute

38 x 42 cm



17806
Busunge

Borsa dimensione media, manici in cotone rinforzati. | Bag with medium size, reinforce cotton handles, in a wide range of bright tones.

Juta, Cotone | Jute, Cotton

38 x 41 cm



.00



17298
Cactus

Borsa in juta con lunghi manici in cotone e chiusura in velcro. | Bag with long handles made of cotton and velcro closure.

Juta | Jute

48 x 34 x 13 cm

240
gr/m²



.00



17290
Assenzio

Borsa in juta naturale con finiture e manici in cotone rinforzato. Finitura cucita | Natural jute bag with trims and reinforced cotton handles. Sewn edges.

Juta Naturale | Natural jute

38 x 16 x 42 cm



.13



17230
Delmona

Borsa con manici bianchi lunghi rinforzati. Laminazione interna. Finiture cucite. | Jute bag with long, reinforced cotton handles of 70cm in white colour. Inside lamination. Stitched finishing.

Juta Laminata, Cotone | Laminated Jute, Cotton

44,5 x 35 x 14 cm

310
gr/m²



.13



54028
Magilla

Borsa con manici corti rinforzati, e soffiati. Interno laminato. | Jute bag with reinforced cotton handles and gussets. Laminated inside.

Juta | Jute

44 x 33,5 x 15 cm



.08

.05



54062
Fiuma

Borsa shopper con chiusura a zip, manici in contrasto. | Shopping bag with zip closure, handles in contrasting color

Juta, Cotone | Jute, Cotton

40 x 37 cm



.04

.08

.23



54064
Frattina

Borsa shopper con grande capienza, finitura rigata nel soffietto. Doppi manici, corto e lungo. | Shopping bag with large capacity, striped side finishing. Double handles, long and short option

Juta, Cotone | Jute, Cotton

42 x 36 x 24 cm



100% COTTON



105 GR/M²

37 X 41 CM



.13



17348

Nihonio

Borsa shopper con finiture cucite, manici lunghi 70cm rinforzati. | 100% cotton shopping bag. With practical long reinforced 70cm handles.

100% Cotone - 105gr/m² | 100% Cotton - 105gr/m²

37 x 41 cm

105 gr/m²

120 GR/M²

37 X 41 CM



.13



17012

Reumu

Borsa shopper con finiture cucite, manici lunghi 70cm rinforzati. | 100% cotton shopping bag. With practical long reinforced 70cm handles.

100% Cotone - 120gr/m² | 100% Cotton - 120gr/m²

37 x 41 cm

120 gr/m²

140 GR/M²

37 X 41 CM



.13



17854

Iselsberg

Borsa shopper con finiture cucite, manici lunghi 70cm rinforzati. | 100% cotton shopping bag. With practical long reinforced 70cm handles.

100% Cotone - 140gr/m² | 100% Cotton - 140gr/m²

37 x 41 cm

140 gr/m²

180 GR/M²

37 X 41 CM



.13



17855

Isenvad

Borsa shopper con finiture cucite, manici lunghi 70cm rinforzati. | 100% cotton shopping bag. With practical long reinforced 70cm handles.

100% Cotone - 180gr/m² | 100% Cotton - 180gr/m²

37 x 41 cm

180 gr/m²

280 GR/M²

37 X 41 CM



.13



17287

Pepe

Borsa prodotta in Europa. Realizzata in cotone OEKO-TEX | Bag manufactured in Europe. Produced with OEKO-TEX cotton

Cotone riciclato - 280 gr/m² | Recycled cotton - 280 gr/m²

38 x 42 cm

280 gr/m²

320 GR/M²

37 X 41 CM



.13



17390

Pianezze

Borsa shopper con ampio scomparto principale, manici lunghi rinforzati. Finitura solida. | Shopping bag with large main compartment, long reinforced handles. Solid finish.

Cotone riciclato - 320gr/m² | Recycled cotton - 320gr/m²

38 x 42 cm

320 gr/m²

140 GR/M²

48 X 48 CM



.13

300 GR/M²

40 X 40 CM



.13

300 GR/M²

40 X 40 CM



.01

120 GR/M²

25 X 30 CM



.01



17351
Sigaro



Borsa shopper manici lunghi. Le sue grandi dimensioni consentono un uso multifunzionale. | Shopping bag. Long handles. Its large size allows for multifunctional use

100% Cotone - 140gr/m² | 100% Cotton - 140gr/m²

48 x 48 cm

140 gr/m²



17484
Novarolo



Borsa shopper con manici lunghi | Tote bag with long handle

100% Cotone - 300gr/m² | 100% Cotton - 300gr/m²

40 x 40 cm

300 gr/m²



17996
Ensa



Borsa shopper con manici lunghi | Long handles tote bag

100% Cotone - 300gr/m² | 100% Cotton - 300gr/m²

40 x 40 cm

300 gr/m²



17361
Bevilacqua

NEW

Shopper con manici da 30 cm, finiture cucite, ampio scomparto principale. | Shopper with 30 cm handles, stitched finishes, large main compartment.

Cotone | Cotton

25 x 30 cm

120 gr/m²



140 GR/M²

42 X 50 CM



.13



17136
Lipsia



Borsa color natural, manici lunghi e finiture cucite. | Bag with natural colour finish. With long handles and stitched finishing.

Cotone - 140 gr/m² | Cotton - 140 gr/m²

42 x 50 cm

140 gr/m²

120 GR/M²

25 X 30 CM



.13



17360
Boara

NEW



Shopper con manici da 30 cm, finiture cucite, ampio scomparto principale. | Shopper with 30 cm handles, stitched finishes, large main compartment.

Cotone | Cotton

25 x 30 cm

120 gr/m²

COTTON BAGS

Shopper with 30 cm handles, stitched finishes





105
GR/M²

36 X 40 CM



120
GR/M²

36 X 40 CM



17397
Dolcè

Borsa shopper con finiture cucite, manici lunghi 70cm rinforzati. | 100% cotton shopping bag. With practical long reinforced 70cm handles.

Cotone - 105gr/m² | Cotton - 105gr/m²

36 x 40 cm

105
gr/m²



17009
Odine

Borsa shopper con finiture cucite, manici lunghi 70cm rinforzati. | 100% cotton shopping bag. With practical long reinforced 70cm handles.

100% Cotone - 120gr/m² | 100% Cotton - 120gr/m²

36 x 40 cm

120
gr/m²



140
GR/M²

36 X 40 CM



180
GR/M²

36 X 40 CM



17848
Bohodukhiv

Borsa shopper con finiture cucite, manici lunghi 70cm rinforzati. | 100% cotton shopping bag. With practical long reinforced 70cm handles.

100% Cotone - 140gr/m² | 100% Cotton - 140gr/m²

36 x 40 cm

140
gr/m²



17514
Zoldo

Borsa shopper con finiture cucite, manici lunghi 70cm rinforzati. | 100% cotton shopping bag. With practical long reinforced 70cm handles.

Cotone - 180gr/m² | Cotton - 180gr/m²

36 x 40 cm

180
gr/m²

100% COTTON

CLASSIC COLOR BAGS

Made of cotton and
available in various
weights





CHOOSE YOUR PANTONE COLOR



.09



CHOOSE YOUR PANTONE COLOR



.09



17282
Nandina



Borsa shopper di cotone. Ampio scomparto principale, manici lunghi, finiture cucite, ampia superficie di stampa. A partire da 250pz può essere realizzata in colore pantone | Shopping bag made of cotton. Large main compartment, long handles, stitched finishing, large printing area. From 250pcs can be produce in pantone color.

Cotone | Cotton
48 x 48 cm

140 gr/m²



17283
Nemesia



Borsa shopper di cotone. Ampio scomparto principale, manici lunghi, finiture cucite, ampia superficie di stampa. A partire da 250pz può essere realizzata in colore pantone. | Shopping bag made of cotton. Large main compartment, long handles, stitched finishing, large printing area. From 250pcs can be produce in pantone color

Cotone - 300 gr/m² | Cotton - 300 gr/m²
40 x 40 cm

300 gr/m²



.09

CHOOSE YOUR PANTONE COLOR



17285
Lugo



Borsa in cotone organico, manici larghi, finiture cucite. Certificato GOTS. Può essere realizzata in colore pantone a partire da 250pz. | Shopping bag made of organic cotton, large handles, stitched finishing. GOTS certificate. From 250pcs can be produced in pantone color.

Cotone Organico - 230gr/m² | Organic Cotton - 230gr/m²
35 x 40 x 12 cm

230 gr/m²



.13



.13



.13

40 X 50 CM

37 X 45 CM

42 X 45 CM



17783
Gorzano



Borsa a rete con tasca interna e manici lunghi. | Net bag with inner pocket and long handles.

Cotone | Cotton
40 x 50 cm - Pochette: 14,5 x 11,5 cm



17785
Artanavaz



Shopper particolarmente adatta per riporre la frutta. Manici medi rinforzati. | Shopping bag especially designed to store fruit. Medium reinforced handles.

Cotone | Cotton
37 x 45 cm

120 gr/m²



17212
Cavaliere



Borsa shopper. Parte alta con trama larga. Manici lunghi. | Shopping bag 100% cotton with upper part with wide texture. Long handles

100% Cotone - 180gr/m² | 100% Cotton - 180gr/m²
42 x 45 cm

180 gr/m²



280 GR/M²
36 X 34 X 12 CM

.08



17504
Sinnesro



Borsa shopper in color natural, manici lunghi colorati. Con soffiotti e finiture cucite. | Shopping bag in natural colour. Long coloured handles. With gussets and stitched finishing.

Cotone - 280 gr/m² | Cotton - 280 gr/m²

36 x 34 x 12 cm

280 gr/m²



.19

.23

.01

130 GR/M²

37 X 41 CM



17853
Noventa



Borsa con corpo in color natural e manici colorati. Manici lunghi 70cm e finiture cucite. | Bag in natural colour and colored handles. With 70cm long handles and stitched finishing.

100% Cotone - 130gr/m² | 100% Cotton - 130gr/m²

37 x 41 cm

130 gr/m²



.01

.23

.04



.06

.08

230 GR/M²

44 X 34 X 15 CM



.13



17998
Taoyuan



Borsa shopper con laminazione interna, con manici lunghi rinforzati, soffiotti e finiture cucite. | Shopping bag, laminated inside, with long reinforced cotton handles, gussets and stitched finished.

Cotone - 230 gr/m², Laminazione Interna | Cotton - 230 gr/m², internal lamination

44 x 15 x 34 cm

230 gr/m²

220 GR/M²

38 X 42 X 8 CM



.13



17389
Nove



Borsa shopper con ampio scomparto principale, soffiotto e manici lunghi rinforzati. | Shopping bag with large main compartment, gusset and long reinforced handles.

Cotone riciclato - 220gr/m² | Recycled cotton - 220gr/m²

38 x 42 x 8 cm

220 gr/m²

240 GR/M²

39 X 42 X 13 CM



.13



17192
Nyumba



Borsa con manici lunghi, con bordatura rinforzata nello stesso materiale. Manici lunghi, finiture cucite. | Canvas cotton bag, high quality with reinforced edges in the same material. Long handles, stitched finishing.

Cotone - 240 gr/m² | Cotton - 240 gr/m²

39 x 13 x 42 cm

240 gr/m²

105 GR/M²

37 X 41 CM



.13



17849
Boise



Borsa pieghevole. Finitura color natural, lunghi manici confortevoli (2,5x70cm) e coulisse coordinata. | Folding bag in resistant cotton of 105gr/m². White natural colour material, with comfortable, long handles -2,5x70cm- and matching colour drawstring.

100% Cotone - 105gr/m² | 100% Cotton - 105gr/m²

C: 37 x 41 cm; K: 20 x 20 cm

105 gr/m²

135 GR/M²

37 X 41 CM



.13



17195
Verdure



Borsa shopper. Può essere ripiegata nell'angolo a tasca. Manici lunghi, finiture cucite. | Shopping bag made of cotton. It has a corner pocket for folding. Long handles, stitched finishing.

Cotone - 135gr/m² | Cotton - 135gr/m²

C: 37 x 41 cm; K: 20 x 20 cm

135 gr/m²



.13



.13



.13

130
GR/M²

38 X 42 CM



130
GR/M²

35 X 7,5 X 38 CM



180
GR/M²

38 X 42 CM



17391
Precalcino



Borsa shopper made in Europe. Manici lunghi. Finiture cucite | Shopper bag made in Europe. Long handles. Stitched finishes

75% Cotone, 25% poliestere | 75% Cotton, 25% Polyester

38 x 42 cm

130
gr/m²



17392
Roncade



Borsa shopper made in Europe. Manici lunghi e soffiato. Finiture cucite. | Shopper bag made in Europe. Long handles and bellows. Stitched finishes.

75% Cotone, 25% poliestere | 75% Cotton, 25% Polyester

35 x 7,5 x 38 cm

130
gr/m²



17363
Bolzano



Borsa realizzata in cotone misto poliestere, ampio scomparto principale, manici lunghi da 70cm. | Bag made of polyester cotton blend, large main compartment, 70cm long handles.

Poliestere 10%, Cotone 90% | Polyester 10%, Cotton 90%

38 x 40,5 cm

180
gr/m²



17503
Sensuell



Borsa shopper con ampio scomparto principale. Manici lunghi rinforzati, soffiati e finiture cucite. | Shopping bag large main compartment. With long reinforced handles, gussets and stitched finishing.

Juco | Juco

40 x 35 x 17,5 cm



.13



JUCCO

JUCCO



.01



17364
Borgo



Borsa con manici rinforzati, da 50cm. Perfetta per la spiaggia o per lo shopping. Con laminazione interna per maggiore resistenza. | Bag with reinforced handles, 50 cm. Perfect for the beach or shopping. With internal lamination for added strength.

Juta, cotone laminato | Jute, laminated cotton

44 x 33,5 x 15 cm

290
gr/m²



17365
Pertiche



Borsa con manici rinforzati, da 50cm. Perfetta per la spiaggia o per lo shopping. Con laminazione interna per maggiore resistenza. | Bag with reinforced handles, 50 cm. Perfect for the beach or shopping. With internal lamination for added strength.

Juta, cotone laminato | Jute, laminated cotton

44 x 33,5 x 15 cm

290
gr/m²



.13

JUCCO



.13



17368
Bonavigo



Borsa realizzata in morbido e resistente poliestere particolarmente adatto alla sublimazione. Ampio scomparto principale. Manici lunghi da 70cm. | Bag made of soft and resistant polyester particularly suitable for sublimation. Large main compartment. 70cm long handles.

Poliestere | Polyester

42 x 38 cm

SPECIAL FOR SUBLIMATION



.09



.09



.13



.02



.02



17211
Tuimazy



Shopper con ampio scomparto principale, manici lunghi rinforzati e finiture cucite. | Shopping bag with large main compartment, long reinforced handles, stitched finishing.

Poliestere | Polyester

34 x 39 cm

450 gr/m²



64126
Mobile



Borsa bianca, particolarmente adatta alla sublimazione. Manici lunghi da 60cm. Finiture cucite | Bag in white colour, especially designed for sublimation. With 60cm, long handles and stitched finishing.

TNT No-woven | TNT No-woven

36 x 40 cm

80 gr/m²



17197
Juupajoki



Borsa convention con scomparto principale aperto. Manico fustellato. Finiture termosaldate. | Convention bag with open main compartment. Die-cut handle. Heat-sealed construction.

TNT No-woven | TNT No-woven

34 x 44 cm

80 gr/m²



17385
Zenson



Borsa shopper multicolore con manici rinforzati lunghi 70 cm. | Multicolored shopper bag with 70 cm long reinforced handles.

Cotone - 180 g/m² | Cotton - 180 gr/m²

38 x 42 cm

180 gr/m²



64334
Motta



Sacca zaino multicolore, chiusura con coulisse | Multicolor backpack bag, draw-string closure

Poliestere 210D | 210D polyester

36 x 42 cm



.13



17220
Dragone

Sacchetto con chiusura con coulisse. | Bag with drawstring closure
100% Cotone - 120gr/m2 | 100% Cotton - 120gr/m2
25 x 30 cm

120
gr/m²

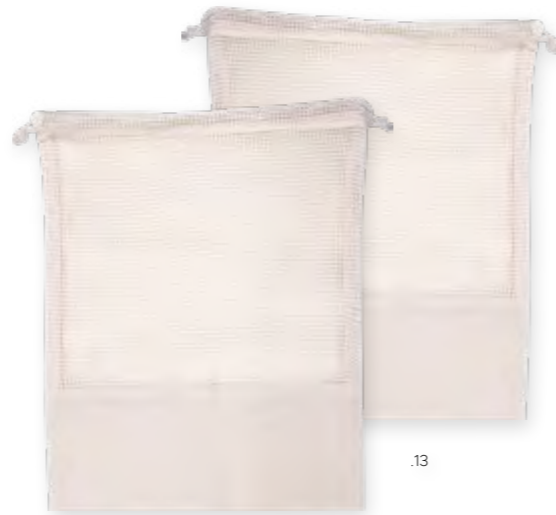

.13



17784
Arcidiaconata

Borsa a rete con chiusura con coulisse e parte bassa rinforzata. | Net bag manufactured with drawstring closure and reinforced lower part. Great for fruit store.
100% Cotone | 100% Cotton
30 x 35 cm

180
gr/m²



.19

.02



17234
Amaro

Borsa riutilizzabile con chiusura con coulisse. | Reusable bag with ribbon closure
Ldpe | Ldpe
30 x 35 cm



.13



17224
Freddo

Borsa con ampio scomparto principale con fascette di chiusura in cotone. Manici lunghi rinforzati. | Bag with large main compartment with inner tape to close it. Long reinforced handles.
100% Cotone Canvas - 280gr/m2 | 100% Cotton Canvas - 280gr/m2
22 x 27 x 10 cm

280
gr/m²



.13



17223
Formone

Sottile borsa per il pane in cotone. Manici corti. | Slim bag for bread. Short handles.
Cotone | Cotton
20 x 50 cm

140
gr/m²



.13



17016
Elvan

Borsa portapane con chiusura con coulisse coordinata. Finiture cucite | Bread bag with matching colour drawstring closure. Stitched finishing.
100% Cotone - 105gr/m2 | 100% Cotton - 105gr/m2
20 x 58,5 cm

105
gr/m²



.02



17041
Ankra

Borsa porta pizze con ampio scomparto principale e manici lunghi rinforzati. | Pizza bag with large main compartment, with long reinforced handles.
TNT No-woven | TNT No-woven
31,5 x 31,5 x 31,5 cm

80
gr/m²



.08

Children and Games

Matite colorate, astucci per penne, pastelli a cera, set scolastici in materiali ecologici, penne a sfera, matite flessibili, quaderni e taccuini, giocattoli, animali in peluche, portachiavi e cornici per foto.

Colored pencils, pen cases, wax crayons, school sets made of environmentally friendly materials, ballpoint pens, flexible pencils, notebooks and notepads, toys, stuffed animals, key-chains and picture frames.



SET OF PENCILS

Includes ball pen, wooden pencil, rubber and ruler.



.00



96028
Deina



Set 6 pezzi con 3 matite, righello 20 cm, gomma e temperino. Fornito in confezione in cartoncino | Set of 6 pieces with 3 pencils, 20cm ruler, eraser and pencil sharpener. Presented in recycled cardboard box.

Legno | Wood

4,2 x 18 x 1 cm



.01



96147
Smask



Set da scrittura con 3 matite in finitura nera, gomma e temperino. Fornito in confezione in cartoncino. | Writing set with 3 pencils with black finish, rubber and sharpener. Presented in cardboard box.

Carta, Legno, Plastica | Paper, Wood, Plastic

17,7 x 4,5 x 1,3 cm



.00



95042
Philipsburg



Set 6 matite. Matite in legno, con finitura naturale. Chiusura scorrevole con righello da 20cm integrato. | Set of 6 pencils in natural wood case. Wooden pencils, with natural finish. Sliding closure cover with built-in 20cm ruler.

Legno | Wood

21 x 2,5 x 3,5 cm



.02



96444
Rafael



Set matite squadrate colorate, 6 pz. Fornite in confezione in cartoncino con finestra. | Squared coloured pencils set, 6 pcs. Presented in cardboard box with window.

Legno | Wood

4,9 x 9,3 x 0,9 cm



.06

.04

.08



96899
Charmtroll



Set 5 pezzi fornito in confezione in cartoncino naturale. Include penna a sfera, matita in legno, temperamatite, gomma e righello. | Set of 5 pieces presented in natural cardboard box. Includes ball pen, wooden pencil, pencil sharpener, rubber and ruler.

Carta Riciclata, Plastica | Recycled Paper, Plastic

4,5 x 17,7 x 1,5 cm



.23



.00



96164
Costa

Set composto da 3 matite in legno con scatola in cartoncino riciclato | Set consisting of 3 wooden pencils with recycled cardboard box

Legno, cartoncino | Wood, cardboard

2,4 x 9 cm



96004
Esme

Set 12 matite lunghe colorate in confezione in cartoncino | Coloured wooden pencil set (large) in recyclable box, 12pc

Legno | Wood

9,5 x 18 x 1 cm



.00



96002
Nelida

Set di 6 matite con finestra. | Set of 6 pencils in natural cardboard box with window.

Legno | Wood

4,9 x 9,3 x 0,9 cm



96006
Fe

Set di 12 matite con finestra. | Set of 12 pencils in natural cardboard box with window.

Legno | Wood

9,5 x 9,3 x 1 cm

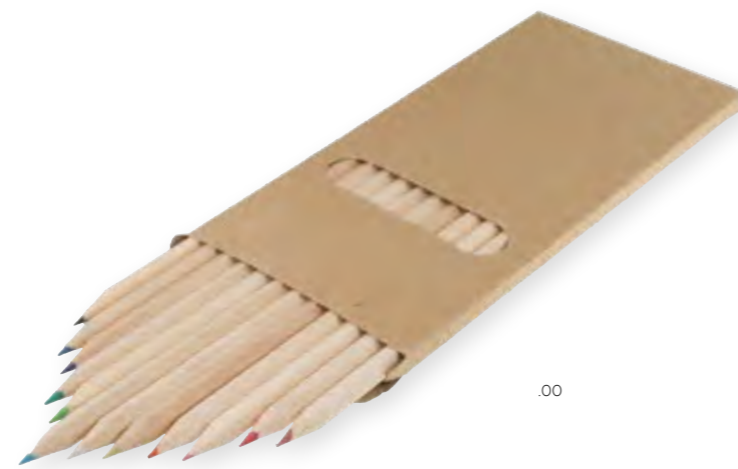

.00

COLOURED WOODEN PENCILS

With natural cardboard box and sharpener.

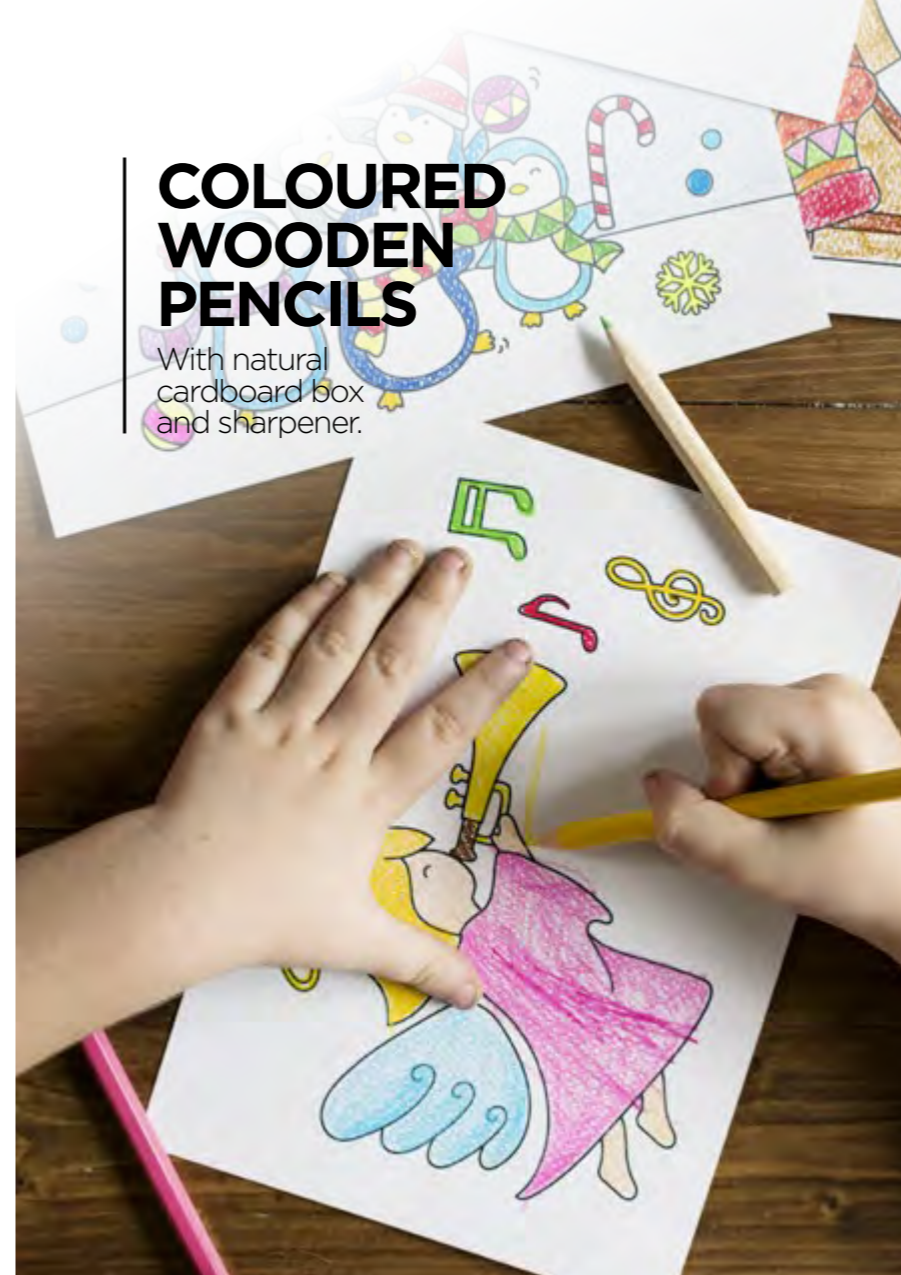

.18 .06 .04 .08



96008
Lulu

Set matite 7 pezzi in tubetto in confezione con cappuccio trasparente. Con matite e temperino. | Set of 7 pieces in natural cardboard box with transparent hood. With pencils and sharpener.

Legno | Wood

Ø 2,7 x 10 cm



PENCILS WITH RUBBER

Assorted animals.

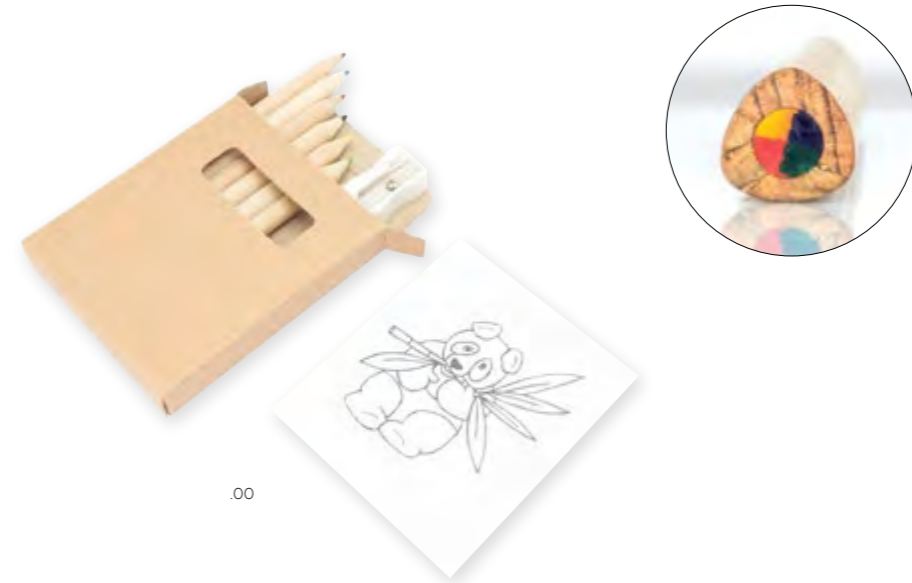

.00

.00



96112
Stoccolma



Set 8 pezzi in cartoncino. Include blocco con 20 disegni da colorare, temperamatite e 6 matite colorate. | Set of 8 pieces in natural finish cardboard box with window. Includes pad with colouring drawings, pencil sharpener and 6 wooden pencils.

Cartone | Cardboard
7,4 x 9 x 1,5 cm



96149
Iska



Matita con mina colorata che scrive contemporaneamente in diversi colori. | Pencil made of poplar wood which mine draws in multiple colours at the same time.

Legno | Wood
17,5 cm



.23

.12

.16

.19

.03

.08

.06

.07

586



96891
Ishigakijima

Matita con gomma. | Pencil with rubber.

Legno, Gomma | Wood, Rubber

19 cm



95109
Aiko

Lavagna magnetica con pennarello in vari colori. Pennarello nero con gomma inclusa. | Magnetic board and thick marker in different colours. Black felt-tip-pen with eraser included.

Plastica | Plastic

10,5 x 15 cm

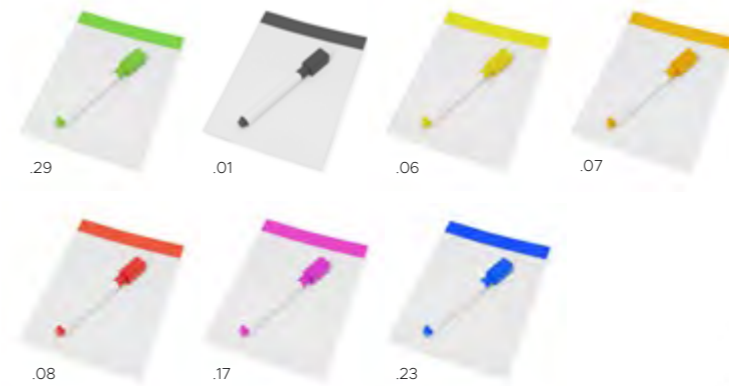

.29

.01

.06

.07

.08

.17

.23



587



.00



96887
Isit

Set da disegno con matite e disegni da colorare, gomma e temperino. | Drawing set with pencils and colouring drawings, rubber and sharpener.

Cartone | Cardboard

21 x 20,5 cm



96151
Badde

Simpatico blocchetto con adesivi nella prima pagina che possono essere incollati e colorati nelle 8 pagine successive. | Funny notebook that includes a first page with stickers and 8 pages to paste and paint them.

Cartoncino, Carta | Cardstock, Paper

8 x 13 cm



INSIDE



OUTSIDE

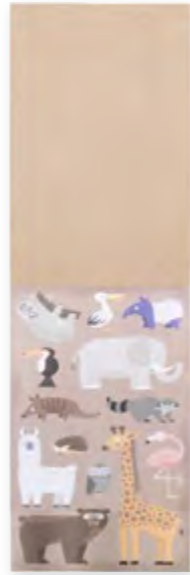

.13



.04

.07

.17

.18



40164
Gonga

Notebook con spirale con cavallino fustellato nella copertina. 50 fogli di carta bianca. | Spiral notebook with a horse-shaped design on the cover and 50 sheets of white paper inside.

Cartoncino, Carta | Cardstock, Paper

8 x 10,5 cm



.00



96090
Saint Petersburg

Set per colorare con 8 pastelli a cera e 8 fogli con disegno da colorare. Confezione in cartoncino con finestra. | Set with 8 pastels and 8 colouring cards, with cardboard box with window.

Cartone | Cardboard

18 x 9 cm



96158
Moscovium

Notebook con copertina in cartoncino con disegno di un piccolo indiano. Comprende matita e 60 fogli. | Notebook with cardboard cover featuring a drawing of a little Indian boy

Carta, cartoncino | Paper, cardboard

9 x 12 cm



.00

.13

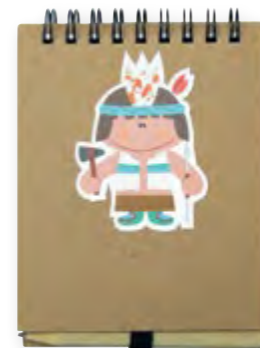

.00



96159
Torio

Set bambini per colorare, include un album e 12 matite colorate | Set for children to color, includes block of various designs.

Carta | Paper

10 x 14,5 x 1 cm



96003
Pegaso

Set di 6 pastelli colorati in scatola in cartoncino. | Set of 6 crayons in natural cardboard box.

Cera | There was

5 x 0,9 x 9 cm



.00

SET OF CRAYONS

In a cylindrical box of natural cardboard.



.00



96150
Huron



Set con 6 pastelli a cera colorati in confezione cilindrica in cartoncino. | Set with 6 coloured crayons presented in a cylindrical cardboard box.

Cartone | Cardboard

☞ Ø 2,7 x 10 cm



.00



96820
Sebe



Set colori in valigetta: include 8 pastelli a cera, 12 acquerelli, matita, gomma e temperamatite. | Wooden case with everything you need: 8 colouring crayons, watercolour, pencil, rubber and pencil sharpener.

Legno | Wood

☞ 18 x 12,5 x 3 cm (Box) , 8,5 cm (Pencil)



.09



96036
Bidi



Set di 4 magneti da colorare con 4 pastelli a cera colorati. | 4 wooden magnets with colouring crayons to colour them.

Legno | Wood

☞ 8 x 2 x 8 cm Box , 8 cm Wax



.00



96027
Jago



Set 15 pezzi in confezione cilindrica. Include 6 matite colorate in legno, temperamatite e 6 pastelli a cera colorati. | Set of 13 pieces in a cylindrical box of natural cardboard. Includes 6 wooden pencils, pencil sharpener and 6 crayons

Legno | Wood

☞ Ø 4,6 x 10 cm



.21



96888
Ishurdi

Set con 6 pastelli a cera con corpo trasparente e cappuccio. Con 6 punte intercambiabili colorate | Set of 6 crayons with transparent body and hood

PP, Cera | PP, Wax

☞ 10 x 2 x 1,5 cm



.00



96167
Pedavena



Gioco di memoria per bambini, fornito con una pouch di cotone. Include un set di pedine in legno e pastelli per colorarli. | Memory game for children, supplied with a cotton pouch. Includes a set of wooden pawns and crayons to color them in.

Legno | Wood

☞ Tokens: 3,7 cm / Bag: 12,5 x 16 cm / Crayons: 9 cm



SUPERHERO CAPE, BAGS AND KITE

With drawings to
be coloured



.02



17206

Guenda

Mantella da supereroe con un divertente disegno da dipingere. Allacciatura regolabile. Fornita con 4 pastelli a cera | Superhero cape with a fun drawing to paint. Adjustable straps. Includes 4 coloured crayons

TNT No-woven | TNT No-woven

48 x 50 cm

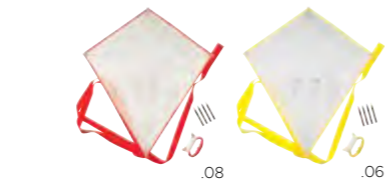

.08

.06



.23



99199

Miazzina

Aquilone con disegno da colorare. Comprende 4 pastelli a cera | Kite with a nice drawing for colouring and 4 crayons

Poliestere 190T | 190T polyester

49 x 60 cm



.02



64307

Sesamo

Simpatica borsa bianca con un divertente disegno di animali e con 4 pastelli per colorarla. | White non woven bag with funny animals drawing

TNT No-woven RPET | TNT No-woven RPET

29,5 x 25 cm



.02



17857

Isilkul

Borsa con disegno da colorare. Include 5 pastelli a cera. Finiture termosaldate. | Bag with drawing to colour. Includes 5 crayons. Heat-sealed finishing.

TNT No-woven | TNT No-woven

20,5 x 22 cm



.02



64272

Vittorio

Borsa per bambini. Con disegno da colorare. Include 5 pastelli a cera vari colori. | Children's backpack with drawstrings. With design for coloring. Includes 5 waxes in varied colors.

TNT No-woven | TNT No-woven

25 x 30 cm

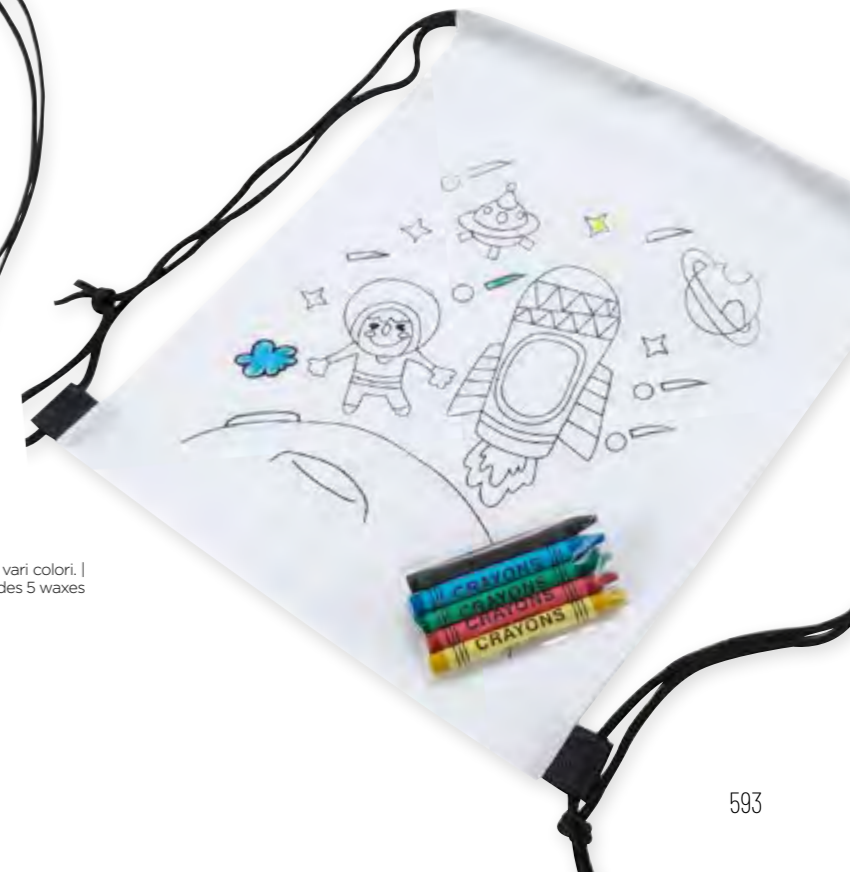



.02



.02



99048
Santorso



Astuccio comprensivo di un set di 6 pastelli a cera. | Case set of 6 wax crayons.

TNT No-woven riciclato RPET | TNT No-woven recycled RPET

23,5 x 12,5 cm



99053
Isili

Astuccio con disegno da colorare. Include 4 pastelli a cera | Pencil case with drawing set. Includes 4 coloured crayons.

TNT No-woven | TNT No-woven

22,4 x 11,6 cm



.09

.02

.00



50051
Shantou



Divertente ventaglio da colorare, con pavese in carta dove poter realizzare i vostri disegni. | Fun fan to color, with paper bunting where you can create your designs.

Bambù, carta | Bamboo, paper

38,5 x 21 cm



99047
Roveré



Astuccio per matite, per bambini, con disegno da colorare. 5 pastelli in colori assortiti inclusi. | Pencil case, for children, with drawing to colour. 5 crayons in assorted colors included.

TNT No-woven | TNT No-woven

22 x 11 cm



.02



.02



64337
Rosà



Sacca zaino con set di pastelli. Chiusura con coulisse. | Backpack bag with set of crayons. Drawstring closure.

TNT No-woven RPET | TNT No-woven RPET

25,5 x 30 cm



.02



17313
Idrogeno

Bavaglino particolarmente adatto alla sublimazione. Chiusura con velcro. | Bib made of special polyester suitable for sublimation.

Poliestere | Polyester

27 x 32 cm



.02



17395
Tribano

Grebiule per bambini, include un set di pastelli per disegnare il logo che preferisci. | Children's apron, includes a set of crayons to draw the logo of your choice.

TNT No-woven RPET | TNT No-woven RPET

40 x 50 cm



.02



17159
Afonino

Grebiule da bambino con disegno da colorare, include 4 pastelli a cera. | Apron with children drawings and a 4 colouring crayons.

TNT No-woven | TNT No-woven

50 x 50 cm



.02



17400
Klaus

Grebiule per bambini con disegno da colorare. Include 5 pastelli a cera. Taglia unica. | Children's apron with coloring design. Includes 5 waxes in various colors. One size.

TNT No-woven | TNT No-woven

43 x 43 cm

COLOURING MARKER SET

With drawings to be coloured.



Children and Games



.09



18076
Aglaonema

Paio di calzini da colorare. Include 3 pennarelli. | Illustrated socks for painting. Includes 3 markers.

Poliestere | Polyester

30 x 8,5 cm ; Marker: 8,5 cm





 29084
Hansi
Temperino colorato | Sharpener
Plastica | Plastic
6 x 4,5 x 1,5 cm

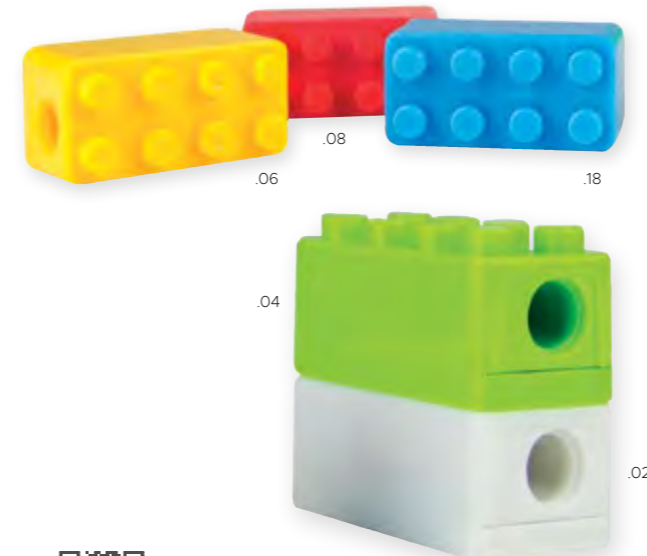

 29252
Grantola
Temperamatite a forma di mattoncino | Pencil sharpener with funny construction shape.
Plastica | Plastic
4 x 2 x 2 cm



 29255
Skurar
Portamatite con portamemo frontale in diversi soggetti assortiti | Pen holder with clip on the front. Different models mixed
Legno | Wood
8,5 x 7 x 5,3 cm



 29191
Odessa
Temperamatite rotondo | Pencil sharpener
Plastica | Plastic
Ø 3,5 cm

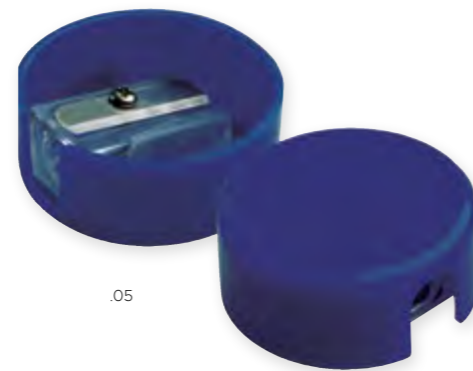

 99059
Rezzato
Set composto da astuccio, matita, temperamatite, gomma e righello. | Set including a case, a wooden pencil, a pencil sharpener, a rubber and a ruler.
Pvc, Plastica | Pvc, Plastic
23 x 10 cm





.07



99040
Polessk

Astuccio con zip. Con tirazip colorato coordinato. | Case with matching colour puller strap.

Pvc | pvc

24,5 x 11,5 cm



.02



43174
Nimat

Astuccio realizzato in speciale poliestere perfetto per la sublimazione. | Pencil case made of special polyester for sublimation

Poliestere | Polyester

22 x 12 cm



.04



99004
Heimo

Astuccio con zip colorata coordinata. | Polyester zipper case with matching colour zipper.

Poliestere 600D | 600D polyester

22 x 11 cm

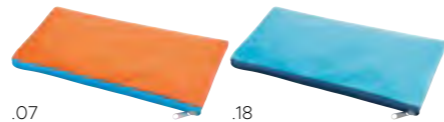

.13



.19



99027
Singapore

Astuccio, zip coordinata e piccoli inserti laterali | Case in natural colour, matching colour zipper and handy side handles

100% Cotone | 100% Cotton

6,5 x 22,5 cm

220 gr/m²



99030
Kingstown

Astuccio con zip. | Pencil case with zipper closure.

TNT No-woven - 80gr/m² | TNT No-woven - 80gr/m²

21 x 11 cm

80 gr/m²

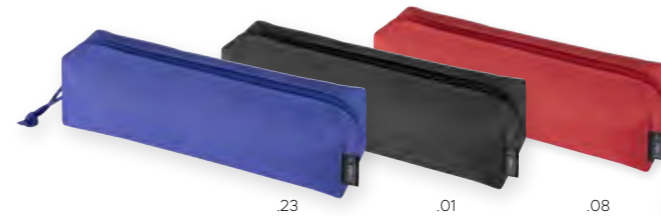

.23

.01

.08



96161
Palladio

Astuccio con tirazip con cordino | Pouch with drawstring puller

Poliestere 600D RPET | 600D RPET polyester

20 x 4,5 x 6 cm





.08 .18



17166
Montevideo

Grembiule da cucina da bambino, in simpatica colorazione bicolore. Con bretella e nastro dietro la schiena regolabili. | Children's apron in cheerful bicolored combination. With neck and back adjustment straps.

TNT No-woven | TNT No-woven

40 x 60 cm

80 gr/m²



.02 .01



17338
Mura

Grembiule lungo. Tracolla con fibbia in plastica. Tasca frontale. | Long apron. Strap with plastic closure. Front pocket.

80% Poliestere, 20% Cotone - 220 gr/m² | 80% Polyester, 20% Cotton - 220 gr/m²

75 x 90 cm

220 gr/m²



.08



.17



.02

.19

.23

.08



17480
Avignon

Set bimbi composto da grembiule e cappello da cucina. Grembiule con tasca frontale e cinghia regolabile. | Children's set of apron and kitchen hat. Apron with front pocket and adjustment straps.

TNT No-woven | TNT No-woven

60 x 40 cm/ Hat size 56

80 gr/m²

GLOSSY FINISH



.06 .05 .02



.02



.08



.02



74005
Madina

Tazza bianca per sublimazione. | Ceramic mug in white, for sublimation printing.

Ceramica | Ceramic

Ø 8 x 9,5 cm



74031
Zuli

Tazza con finitura lavagna. Gessetto incluso. | Mug with blackboard. Chalk included.

Ceramica | Ceramic

Ø 8 x 9 cm



74134
Kosulino

Tazza bianca con un inserto lavagna nero a forma di fumetto, comprende gessetto bianco. | White ceramic mug with a black bubble on its front and a white chalk to paint on it.

Ceramica | Ceramic

Ø 9 x 10,5 cm



.06



74055
Maike

Tazza a forma di giraffa | Ceramic mug in a shape of giraffe

Ceramica | Ceramic

Ø 8,3 x 9,7 cm



.00



74052
Malin

Tazza a forma di elefantino. | Ceramic mug in a shape of elephant

Ceramica | Ceramic

Ø 8,32 x 9,4 cm



YOUR BESPOKE BABY BIBS



DOUBLE FACE



Perfect for baby's first foods
Soft and strong
Lab tested safe

OEKO-TEX®
CONFIDENCE IN TEXTILES
STANDARD 100

MOQ
100 pcs



17273
Baby-bib

Bavaglino personalizzato. Prodotto stampato digitale di alta qualità. | Baby bib customized. High quality digital printed product.

Fronte microfibra, retro cotone | Microfiber front, cotton back

25 x 35 cm



bespoke
expert in special productions

YOUR BESPOKE BABY TOWELS



Wrap your little one in a fluffy, soft and gentle towel



MOQ
100 pcs

DOUBLE FACE



18071
Baby-towel

Asciugamano quadrato con cappuccio cucito in un angolo per coprire la testa del bambino. Stampa su cappuccio | Square towel with an extra sewn-on hood at one corner to cover a baby's head. Printing on the hood

100% Cotone terry - 340gr/m2 | 100% Cotton terry - 340gr/m2

80 x 80 cm



OEKO-TEX®
CONFIDENCE IN TEXTILES
STANDARD 100



64308
Shichimi



Sacca zaino con disegno di simpatici animalletti. Chiusura con coulisse | Drawstring backpack with design of cute little animals. Drawstring closure

Poliestere RPET 190T | 190T RPET polyester

26 x 30 cm



64289
Rosmarino



Sacca zaino con un simpatico disegno di piccoli indiani, coulisse corda dello stesso materiale. | drawstring backpack with a cute design of small Indians, drawstring rope of the same material.

Cotone - 140 gr/m2 | Cotton - 140 gr/m2

28 x 32 cm

140 gr/m²



64084
Inga

Sacca zaino con coulisse | Drawstring bag

TNT No-woven | TNT No-woven

30 x 35 cm

80 gr/m²



64312
Picchio

Sacca zaino a forma di animalletto | Backpack with funny animal shapes.

Poliestere 190T | 190T polyester

26 x 30 cm



64016
Kay

Sacca zaino pieghevole con custodia a forma di animale. Chiusura con coulisse. Con moschettone in plastica. | Folding backpack kept within a comfortable animal-shaped bag. With drawstring closure. With plastic carabiner.

Poliestere 190T | 190T polyester

26 x 32 cm



64181
Montecarlo

Sacca zaino pieghevole con chiusura con coulisse, si ripiega all'interno dell'animalletto, con piccolo moschettone. | Foldable rucksack with drawstring closure, folds inside the pet, with a small carabiner.

Poliestere 190T | 190T polyester

26,5 x 32,5 cm



64195
Garbagnate

Sacca zaino per bambini. Con chiusura con coulisse e angoli rinforzati. | Drawstring backpack for children. Reinforced corners. Small folding size.

Poliestere 210T | 210T polyester

30 x 40 cm

T-SHIRT FOR PLUSH

Teddy bear plush.



95291
Nicki

Peluche topolino. T-shirt esclusa | Mouse plush. T-shirt excluded.

Peluche | Peluche

20 cm



95251
Kea

Orso Bianco di peluche. T-shirt esclusa. | White teddy bear. T-shirt excluded.

Peluche | Peluche

20 cm



95269
Iner

Peluche orso (maglia esclusa) | Bear plush. T-shirt excluded.

Peluche | Peluche

20 cm



95256
Zippora

Peluche orsetto con maglietta | Teddy bear plush. T-shirt included.

Peluche | Peluche

12 cm



95076
Bassa

Peluche orsetto con T-shirt per la personalizzazione. | Teddy bear and white T-shirt to place your advertisements.

Peluche | Peluche

15 cm



95250
Tida

T-shirt per peluche | Plush t-shirt

Poliestere | Polyester

Unique size



95244
Klivi

Peluche orso (maglia inclusa) | Bear plush. T-shirt included

Peluche | Peluche

20 cm



95283
Murom

Peluche orsetto portachiavi con t-shirt. | Teddy bear keychain with t-shirt

Poliestere | Polyester

6,5 x 7,5 x 4 cm



95077
Guija

Portachiavi peluche orsetto con moschettone colorato coordinato | Keychain in the shape of teddy bear with matching plastic clasp.

Poliestere | Polyester

8 cm



95122
Lantanio

Dudù con peluche per neonati | Blanket with stuffed toy for babies

Poliestere | Polyester

44 x 38 cm



14052
Germanio

Morbida coperta per bambini, con un tenero orsetto | Fun sized soft blanket for children, with a cuddly teddy bear

Poliestere | Polyester

100 x 75 cm



95071
Kurma

Peluche renna. T-shirt inclusa | Reindeer plush. T-shirt included

Poliestere | Polyester

15 cm



95075
Värde

Peluche a forma di elefante, orso o cane. Bandana da collo per la stampa. | Pet of 23 cm height with elephant, bear or dog shape. It has a bandana in its neck for printing.

Poliestere | Polyester

Elephant: 22,5, Dog: 22,5, Bear: 23,5



95123
Magnesio

Morbido peluche con piccola bandana per la stampa. | Soft stuffed Toy with small accessory for printing.

Poliestere | Polyester

20 cm



96160
Vänskaplig

Scatolina in cartoncino con 4 gessetti XL colorati. | Case in recycled cardboard, with 4 chalks.

Gesso | Plaster

9,5 x 2,5 x 11 cm



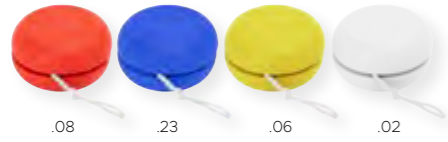

.08 .23 .06 .02



.06 .02 .23 .01 .08



.19



.00



.04



95064
Sibó



Yo-yo colorato. | Yo-yo in a fun range of bright tones.

Legno | Wood

☐ 3 x 5 cm



95055
Gorg



Yo-yo | Yo-yo.

Legno | Wood

☐ Ø 5,4 x 3,8 cm



95737
Aloe



Yo-yo | Yo-yo

Plastica PS | PS plastic

☐ 2,5 x Ø 4,5 cm



95741
Brusali



Puzzle, 16 pezzi | Wooden puzzle with 16 pieces

Legno | Wood

☐ 15 x 15 x 0,5 cm



.00



.19 .06 .18 .17 .05



.08



99037
Cannella

Salvadanaio a forma di porcellino | Pig-shaped money box

Plastica | Plastic

☐ 6 x 8 x 7 cm



.05

.01

.08



99100
Gombito

Salvadanaio a forma di barattolo che può anche essere usato come portapenne togliendo il coperchio. | Coin bank made of tin which can also be used as a container for pencils by removing the top cover.

Metallo | Metal

☐ 7,5 x 10,5 x 7,5 cm



.02



95996
Assa



Puzzle in cartoncino, composto da 16 pezzi. Adatto alla personalizzazione in digitale. | Puzzle made of paperboard with 16 pieces, great for digital customization.

Cartoncino | Cardboard

☐ 13,5 x 13,5 cm



PUZZLE AND GAMES

Challenging and fun games for kids.

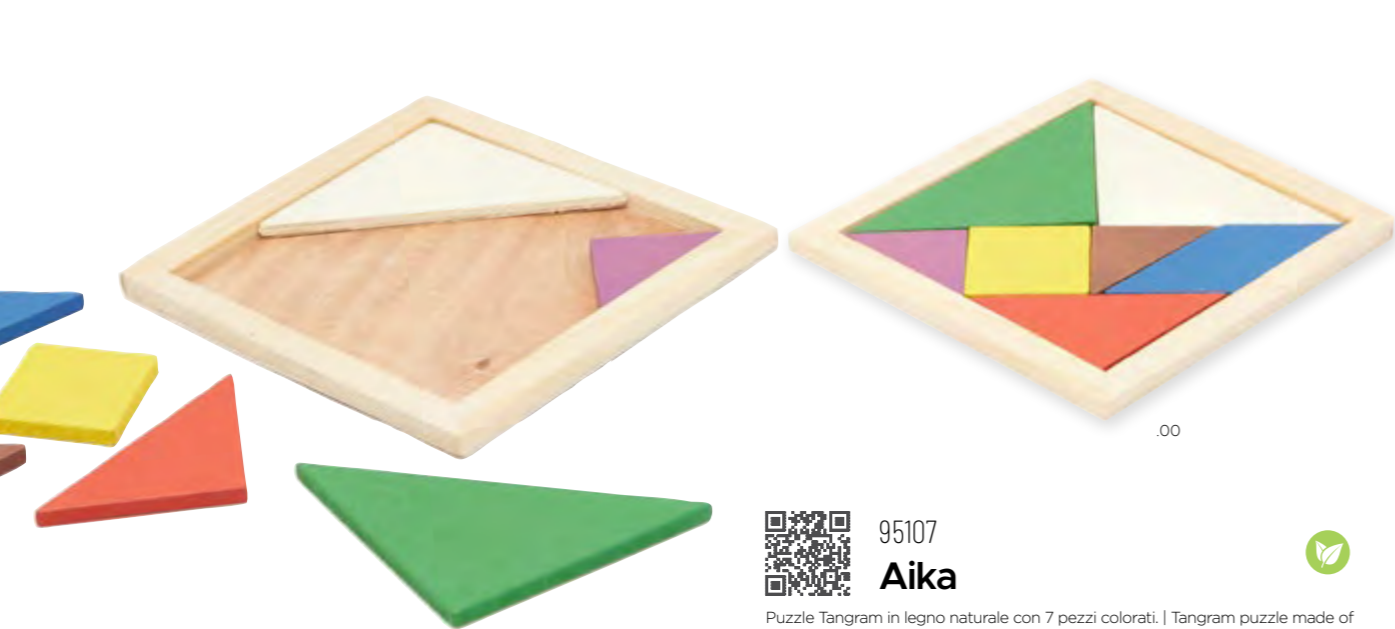

95107
Aika



Puzzle Tangram in legno naturale con 7 pezzi colorati. | Tangram puzzle made of wood with 7 colour pieces.

Legno | Wood

10,3 x 10,3 x 0,7 cm



95127
Valbrenta



Mazzo di carte francese. 54 carte incluse. Fornito in confezione singola dal design eco. | French deck of cards. 54 cards included. Supplied in eco-designed single pack.

Cartoncino Riciclato | Recycled Cardboard

9 x 2 cm



95115
Gymnocalycium



Set di 2 giochi da tavolo: mazzo di carte francese e dadi. Presentato in una scatola di legno. | Set of 2 table games: French cards and dice. Presentation in a wooden box.

Legno | Wood

10 x 2,5 x 9,1 cm



.09



95024
Gord



Giochi a forma di cubetto, 24 varianti disponibili. | Cubic skill set with 24 modes available.

Plastica | Plastic

25,5 x 17 x 4,1 cm



.00



95129
Erbezzo



Set gioco composto da 10 birilli in legno e 2 palline. Custodia in cotone inclusa, facile da trasportare. Fornito in confezione singola dal design eco. | Game set consisting of 10 wooden skittles and 2 balls. Cotton pouch included, easy to carry. Supplied in eco-designed single pack.

Legno, Cotone | Wood, Cotton

32 x 34 cm



.00



95119
Vanadio



Set in legno composto da 15 pezzi con numeri e simboli matematici, fornito in pouch di cotone. | Set of wooden pieces with numbers and mathematical symbols

Legno, Cotone | Wood, Cotton

Borsa: 10,5 x 13 cm / Elementi in legno: 2 x 3 cm





.00



95083
Agatone



Set di abilità da 7 pezzi per i più creativi, confezionato in una pouch in cotone con chiusura a coulisse. | 7-pieces skill game presented in a durable cotton case with a drawstring closure

Legno | Wood

📏 4,5 x 4,5 x 4,5 cm - Pochette: 10 x 12,5 cm



.00



95201
Armea



Gioco della torre con 45 pezzi in legno. Fornito in pouch di cotone | Tower game with wooden 45 pieces. Presented in a cotton pouch with drawstring closure.

Legno | Wood

📏 5,7 x 17 x 5,7 cm



.00



95020
Breindel



Set da 3 giochi. Fornito in confezione singola di legno. | Set of 3 natural wood skill games. Presented in a wooden box.

Legno | Wood

📏 16,3 x 6 x 6,4 cm



.00



95128
Villaga



Gioco del tris in legno. Include 10 pezzi contenuti in una pouch in cotone naturale. | Wooden tic-tac-toe game. Includes 10 pieces contained in a natural cotton pouch.

Legno | Wood

📏 13 cm



.00



95998
Lackkugga



Gioco del tris. Fornito in scatola in legno. | Tic-tac-toe game presented in a wooden box.

Legno | Wood

📏 7 x 2,6 x 7 cm



.00



95048
Udele



Gioco di abilità mikado con 41 bastoncini. Fornito in confezione di legno. | Classic skill game mikado with 41 wooden sticks. Presented in wooden box.

Legno | Wood

📏 19 x 2,5 x 4 cm



.00



95046
Trina



Gioco domino classico composto da 28pz. In legno, con tessere nere e dettagli bianchi. Fornito in scatola di legno. | Domino game with 28 pcs. Made of wood, with pieces in colour with white colour details. Presented in an individual wooden case.

Legno | Wood

📏 16,5 x 3,5 x 5 cm





.00



95114
Giglio



Set giochi in legno, comprende: mikado, scacchi, dama e domino. Fornito in una scatola con coperchio scorrevole con scacchiera stampata all'interno. | Set of 4 games of skill: mikado, chess, draughts and dominoes. Presentation in a box with double function sliding lid as checked board on its inner side.

Legno | Wood

16,6 x 3 x 16,5 cm



.00



95126
Annone



Pratica scacchiera richiudibile | Practical foldable chessboard

Legno | Wood

21 x 10,5 x 2,6 cm



.08

.01

.02

.23

.06



95881
Walti

Bracciale riflettente, con meccanismo autoregolante. | Reflective bracelet, with automatic adjustment mechanism.

Pvc | pvc

2,9 x 23 cm

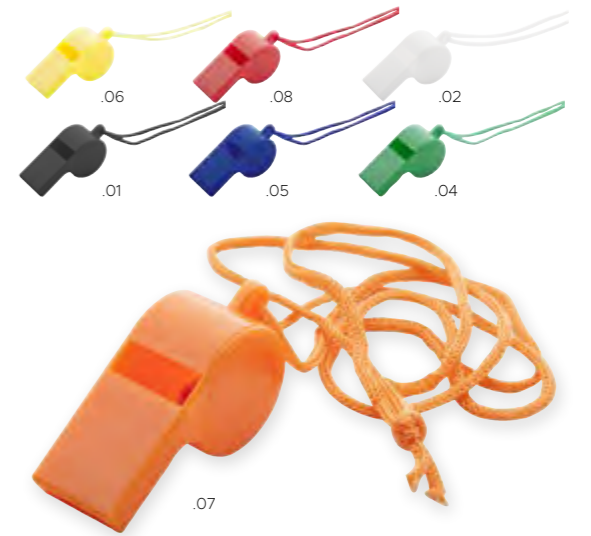

.06

.08

.02

.01

.05

.04

.07



95025
Mitzi

Fischietto classico con laccetto da collo colorato coordinato. | Whistle with matching colour neckband.

Plastica | Plastic

5 x 2 x 1,7cm



.00



95116
Trigonella



Gioco di abilità con un divertente design a forma di labirinto | Skill game with fun maze design.

Legno di pino, PE | Pine wood, PE

11,5 x 2,5 x 11,5 cm



29210
Edimburgo

Giocattolo autobus | Bus toy

Plastica | Plastic

15,7 x 3,6 cm



43028
Halle

Giocattolo a forma di camion. Ampia superficie di stampa. Includes transparent plastic presentation box. | Freight truck toy. Large printing area. Includes transparent plastic presentation box.

Plastica | Plastic

18 x 3 x 4,5 cm



.44

.48

.45



.02



.02

Leisure and Outdoor

Coperte in vari tessuti e forme,
bussole, sacchi a pelo, tende
da campeggio, accessori
per barbecue e attrezzi da
trekking.

Blankets in various fabrics and
shapes, compasses, sleeping
bags, camping tents, barbecue
equipment, and hiking gear.

Leisure

and

Outdoor



POLAR BLANKET

Blanket equipped with a kraft paper card for personalization



.13

.05

.03



14030
Liriope

NEW

Coperta dotata di un cartoncino in carta kraft per la personalizzazione e nastro colorato coordinato. | Blanket with two finishes, one side coral fleece and the other side sherpa.

Fleece - 380gr/m2, sherpa | Fleece - 380gr/m2, sherpa

125 x 160 cm

380 gr/m²



.03

.13

.10



.05



14776
Teton

Coperta con due finiture, un lato vellutato e l'altro lato Sherpa | 2-sided blanket. One is velvety and the other with Sherpa finish

Poliestere - 200gr/m2 | Polyester - 200gr/m2

120 x 160 cm

220 gr/m²

200 gr/m²

1st side 2nd side



.13



.03



14054
Brugine

NEW

Morbida coperta perfetta per riscaldarvi nelle fredde sere invernali | Soft blanket perfect for keeping you warm on cold winter evenings

Poliestere | Polyester

120 x 160 cm

240 gr/m²

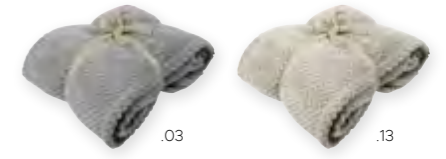

.03

.13



.05



14767
Voldemort

Morbida coperta con finitura originale. Adatta al ricamo. Fornita piegata con nastro con fiocco. | Soft blanket in an original finishing. Suitable for embroidery. Presented folded with ribbon.

Poliestere | Polyester

110 x 160 cm

320 gr/m²



.13

.03



14766
Simmaco

Coperta, con entrambi i lati lisci. Fornita piegata con nastro con fiocco. | Blanket made of high quality polyester with both sides of smooth material.

Poliestere | Polyester

120 x 160 cm

350 gr/m²

180 gr/m²

1st side 2nd side



.00 .05 .08 .03



.13



14124
Buuren

Coperta in diversi colori brillanti, con trattamento anti-pilling. | Blanket in a varied range of bright tones. Polar fleece anti-pilling material.

Fleece - 260 gr/m2 | Fleece - 260 gr/m2

130 x 160 cm

240 gr/m²



.08 .60



.05



14031
Origano

Coperta in fleece | Polar fleece blanket

Poliestere - 165 gr/m2 | Polyester - 165 gr/m2

110 x 150 cm

165 gr/m²

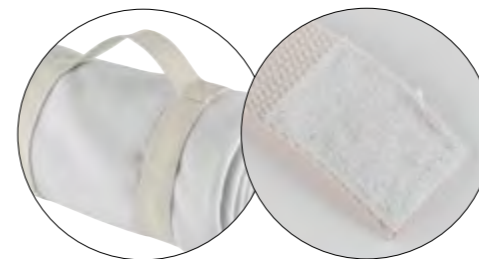

.00



14053
Brogliano

NEW

Porta coperta con chiusura in velcro per trasportare facilmente coperte ripiegate a forma di cilindro. Coperta non inclusa. | Blanket holder with velcro closure to easily carry blankets folded into a cylinder shape. Blanket not included

Cotone | Cotton

48 x 20 cm



.05 .13 .08



.08 .07 .03
.01 .23 .04



.19



14120
Mark

Coperta con cucitura decorativa sui bordi. Fleece blanket with decorative stitching on edges. Size 145x95cm. 180gr/m2 | Fleece blanket with decorative stitching on edges. Fleece blanket with decorative stitching on edges. Size 145x95cm. 180gr/m2

Fleece | Fleece

145 x 95 cm

180 gr/m²



14022
Giò

Coperta in fleece in tinta unita. Trattamento anti-pilling da un lato. | Plain fleece blanket with anti-pilling treatment on one side.

Poliestere | Polyester

120 x 150 cm

180 gr/m²



.13



14141
Guspini



Morbida coperta. Fornita confezionata con un nastro in cotone. | Soft blanket made of 100% cotton. Presented with a ribbon of the same material.

100% Cotone - 360gr/m2 | 100% Cotton - 360gr/m2

130 x 160 cm

300 gr/m²



SOFT BLANKET GREEN LINE

Soft blanket made of 100% cotton. Presented with a ribbon of the same material.



14032
Corylopsi



Coperta in fleece in RPET (materiale riciclato da bottiglie di plastica) e poliestere | Polar fleece blanket, made of RPET and polyester.

30% RPET, 70% Poliestere - 180 gr/m2 | 30% RPET, 70% Polyester - 180 gr/m2

120 x 160 cm

180 gr/m²



14033
Corniolo



Coperta in fleece in stile britannico, realizzata in RPET (materiale riciclato da bottiglie di plastica) e poliestere. | Polar fleece blanket, British style, made of RPET (Recycled material from plastic bottles) and polyester.

30% RPET, 70% Poliestere - 180 gr/m2 | 30% RPET, 70% Polyester - 180 gr/m2

120 x 160 cm

180 gr/m²



14049
Garam



Coperta da picnic formato famiglia. Ideale per le attività all'aperto. Pieghevole. | Family size picnic blanket. Ideal for outdoors.

Polar fleece RPET, 600D RPET, PEVA | Polar fleece RPET, 600D RPET, PEVA

120 x 150 cm

75 gr/m² 150 gr/m²



14050
Garofano



Coperta da picnic formato famiglia. Ideale per le attività all'aperto. Pieghevole per essere trasportata facilmente. | Family size picnic blanket. Foldable for easy transport.

Polar fleece RPET, PEVA, RPET 600D | Polar fleece RPET, PEVA, RPET 600D

120 x 150 cm

75 gr/m² 150 gr/m²



14051
Simba



Coperta da picnic formato famiglia. Ideale per le attività all'aperto. Pieghevole per essere trasportata facilmente. | Family size picnic blanket, made of acrylic material and plaid design

Acrilico, EPE, PP, RPET 600D - 120 gr/m2 | Acrylic, EPE, PP, RPET 600D - 120 gr/m2

130 x 150 cm

120 gr/m²

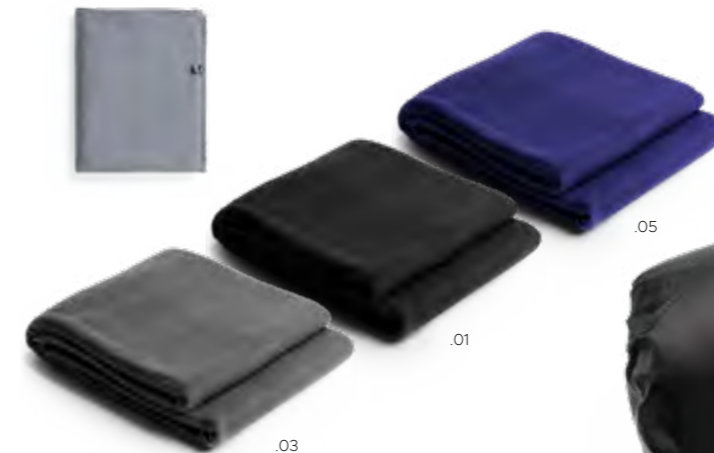

14021
Gino



Coperta realizzata in polar fleece RPET con pouch in RPET ed etichette distinte | Blanket in polar fleece RPET material, with RPET string closure cover and distinctive labels.

Poliestere RPET - 200 gr/m2 | RPET polyester - 200 gr/m2

120x150

200 gr/m²





.09



.05

.03

.01



.08



14780
Timpanogos

Coperta con due finiture, un lato vellutato e l'altro lato Sherpa | 2-sided blanket. One is velvety and the other with Sherpa finish

Pile poliestere - 180gr/m2 | Polyester fleece - 180gr/m2

120 x 150 cm

180 gr/m²



14023
Gisella

Coperta in fleece tinta unita. Trattamento anti-pilling da un lato. Custodia rettangolare in tessuto Oxford di poliestere e rete. | Plain fleece blanket with matching pouch. Anti-pilling treatment on one side.

Poliestere | Polyester

Blanket: 130 x 160 cm - Pouch: 33 x 28 cm

200 gr/m²



.18

.07



.08

.04

.23

.05

.03

.01



.08



14541
Burk

Coperta con trattamento anti-pilling e comoda maniglia in morbido poliestere con chiusura in velcro, comoda per il trasporto. | Blanket with anti-pilling treatment and carrying handle with velcro closure.

Fleece - 180 gr/m2 | Fleece - 180 gr/m2

160 x 125 cm

180 gr/m²



14759
Taman

Coperta con trattamento anti-pilling e comoda maniglia con chiusura in velcro, comoda per il trasporto. | Blanket with anti-pilling treatment and carrying handle with velcro closure.

Fleece - 180 gr/m2 | Fleece - 180 gr/m2

160 x 130 cm

180 gr/m²

bespoke
expert in special productions



.13



14765
Ralph



Federa per cuscino in morbido poliestere con finitura liscia, particolarmente adatto alla sublimazione. | Cushion cover made of soft polyester with a smooth touch especially designed for a sublimation printing.

Poliestere | Polyester

40 x 40 cm

bespoke
expert in special productions



.02



14768
Yasuri



Coperta particolarmente adatta alla sublimazione | Blanket suitable for sublimation

Poliestere | Polyester

120 x 150 cm

200 gr/m²

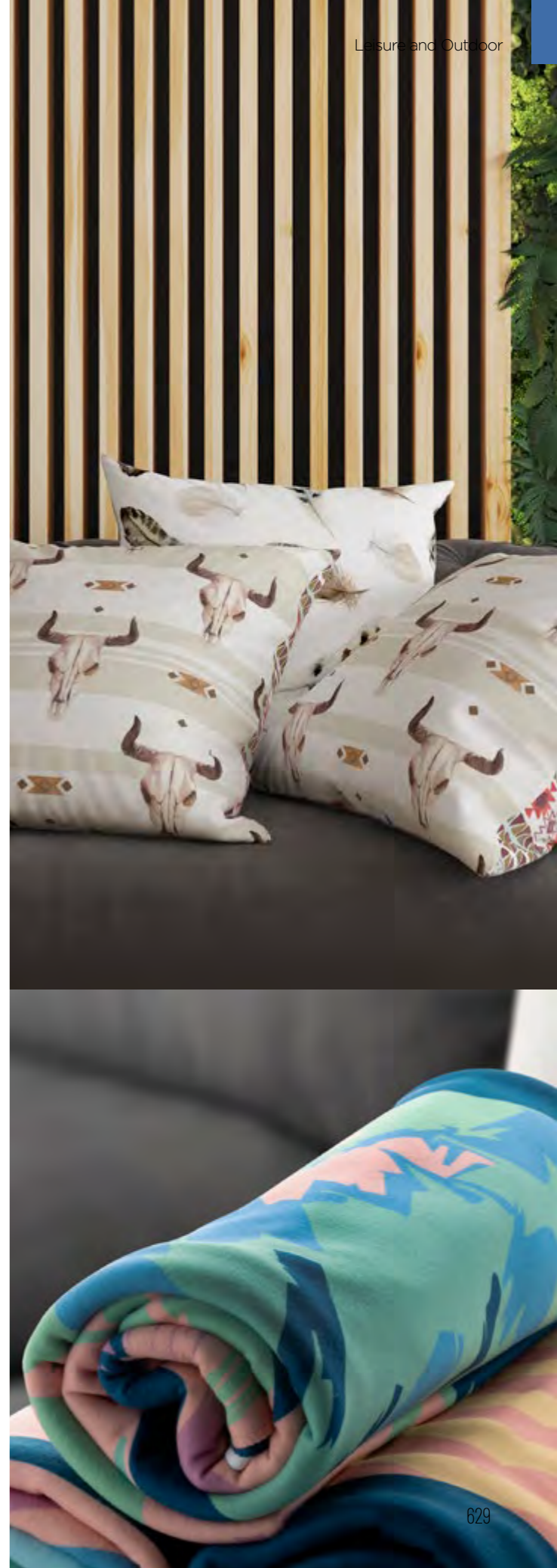



.02



18075
Stira



Calze lunghe, adatte alla sublimazione. | Long socks, with sublimation finish.
Poliestere | Polyester
7,5 x 35 cm



.02



R0381
Kalox



Calzini per sublimatico. Tallone e punte nere. Tessuto effetto cotone | Mid-calf socks for sublimation. Heel and toes in black colour. Cotton touch fabric
94% poliestere, 6% Spandex
Size 36/39, 40/42, 43/46



LONG SOCKS
With sublimation finish.



.02



18083
Ossigeno



Calze made in Europe, adatte per una personalizzazione full color. Realizzate su richiesta con la grafica fornita dal cliente. | European made socks, suitable for full color designs

80% Cotone, 18% Poliamide, 2% Elastane | 80% Cotton, 18% Polyamide, 2% Elastane

Size 39-42 | 43-46



.02



18082
Osmio



Calze made in Europe, adatte per una personalizzazione full color. Realizzate su richiesta con la grafica fornita dal cliente | European made socks, suitable for full color designs

80% Cotone, 16% Poliamide, 4% Elastane | 80% Cotton, 16% Polyamide, 4% Elastane

Size 35-39 | 40-43



.02

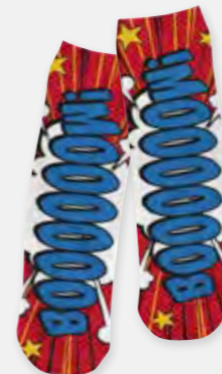

18061
Anènone



Calzini per sublimazione | Socks for sublimation

Poliestere | Polyester

7,5 x 27 cm





53008
Porcellana

Cestino da picnic con accessori per 2 persone e scomparto termico. Tutti gli accessori sono ben riposti e assicurati grazie ai loro gancetti. | Wicker Picnic basket with accessories for 2 people. All accessories are correctly placed and ordered inside thanks to their hooks.

Vimini, Legno, Acciaio Inox, Ceramica, Vetro, PP, Poliestere | Wicker, Wood, Stainless Steel, Ceramic, Glass, PP, Polyester

Cestino: 40 x 30 x 17 cm / Coperta: 19 cm / Coltel



52204
Platino

Cestino da picnic con accessori per 4 persone. Tutti gli accessori sono ben riposti e assicurati grazie ai loro gancetti. | Wicker Picnic basket with accessories for 4 people. All accessories are correctly placed and ordered inside thanks to their hooks.

Vimini, Legno, Acciaio Inox, Ceramica, Vetro, PP, Poliestere | Wicker, Wood, Stainless Steel, Ceramic, Glass, PP, Polyester

Cestino: 46 x 30 x 23 cm / Coperta: 143 x 128 cm



57462
Allione

Bastoni da passeggio telescopici con impugnatura ergonomica, comode cinghie da polso, accessorio per la neve. Forniti in pouch. | Telescopic walking sticks with ergonomic grip, comfortable wrist straps, snow accessory. Presented in an individual pouch.

Alluminio | Aluminum

140 cm



56008
Iole

Bussola con moschettoni | Compass with carabiner

Plastica | Plastic

3 x 6,5 cm

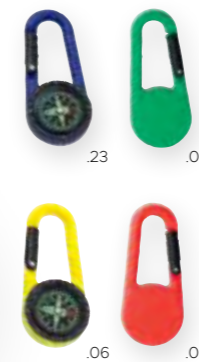

R8310
Megos

Scarpe studiate per il trekking. Lacci rotondi, rete traspirante e dettagli in pelle sintetica. | Trekking shoes with round laces, breathable mesh and details in matching synthetic leather

Poliestere | Polyester

38-47



Summer and Beach

Occhiali da sole, giochi all'aperto, ombrelloni, sedie da spiaggia, borse estive, accessori da spiaggia, ventagli, borse termiche, materassini e cuscini gonfiabili, cappelli estivi e molto altro ...

Sunglasses, open-air games, beach umbrellas & chairs, summer and holiday bags, sunbathing sets, pocket fans and cooler bags, air mattresses and cushions, summer hats and much more..

Summer

and

Beach

4

MULTICOLOR SUNGLASSES

Sunglasses with UV400 protection glossy finish frame in fun colours and black lenses.



 **56003**
Osten

Occhiali da sole con confortevole montatura in finitura opaca e lenti con protezione UV400. | Sunglasses with frame in matt finish and UV400 protection lenses.

Plastica | Plastic

 15 x 16,5 x 4 cm



 **56895**
Belyj

Occhiali da sole con montatura effetto legno. Protezione UV400, con lenti fumè. | Sunglasses with frame in wood-alike material. UV400 protection, with smart, smoked lenses.

Plastica | Plastic

 15 x 16,5 x 4,8 cm

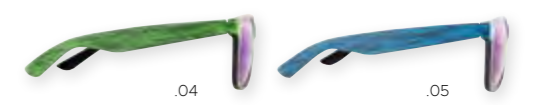

 **56031**
Patagonia

Occhiali da sole pieghevoli con protezione UV400. Con montatura con finitura lucida e lenti nere. | Folding sunglasses with UV400 protection, with glossy finish frame and black lenses.

Plastica | Plastic

 15 x 16,5 x 4 cm



 **56037**
Utforska

Occhiali da sole con montatura colorata effetto legno. Lenti a specchio con protezione UV400. | Sunglasses made of imitation coloured wood plastic. UV400 mirror lenses.

Plastica | Plastic

 14,5 x 5,1 cm



 **56020**
Tiepo

Occhiali da sole protezione UV400. Con montatura con finitura lucida e lenti nere. | Sunglasses with UV400 protection. With glossy finish frame and black lenses.

Plastica | Plastic

 15 x 16,5 x 4 cm





.04



56011
Bresle

Occhiali da sole con protezione UV400. Con montatura semitrasparente e lenti a specchio colorate | Sunglasses with UV400 protection. With translucent frame finish in and matching colour mirrored lenses.

Plastica | Plastic

15 x 16,5 x 4 cm



56047
Porro

Occhiali da sole dal design classico con finitura nera opaca e lenti specchio. Protezione UV400. | Classic design sunglasses with matte black finish and mirror lenses

Vetro | Glass

9,3 x 1,5 x 14,3 cm



56015
Negrar



Occhiali da sole con protezione UV400. Montatura in RPET e lenti AC (acetato di cellulosa) in nero. | Sunglasses with UV400 protection. Frame and arms in RPET. AC lenses in black, available in a wide range of colours.

RPET | RPET

9,3 x 1,5 x 14,3 cm



FASHION SUNGLASSES

UV400 protection



56027
Morenci

Occhiali da sole con protezione UV400. Montatura con finitura semitrasparente, astine colorate e lenti colorate coordinate a specchio. | Sunglasses with UV400 protection. With translucent frame finish, coloured arms and matching colour mirrored lenses.

Plastica | Plastic

15 x 16,5 x 4 cm





NATURE LINE SUNGLASSES

With UV400
protection.

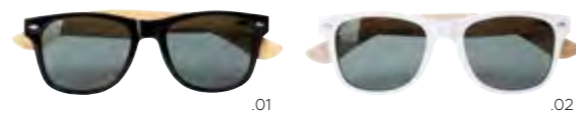

56044
Carol



Occhiali da sole con montatura lucida e stecche in bambù naturale. Lenti con protezione UV400. | Sunglasses with shiny finish frame and natural bamboo temples. UV400 protection lenses.

PC, Bamboo | PC, Bamboo

14,5 x 5 x 3,2 cm



WHEAT FIBER



56113
Tisul



Occhiali da sole dal design classico. Lenti colorate. | Sunglasses with classic design. Coloured lenses.

60% Fibra Di Grano, 40% PP | 60% Wheat Fibre, 40% PP

14,5 x 4,5 cm



GLOW IN THE DARK



56019
Emerald

Occhiali da sole fluorescenti | Sunglasses glow in the dark.

Plastica | Plastic

15 x 15 x 4,5 cm



56107
Gruaro

Occhiali da sole con montatura colorata nei colori delle bandiere italiana, francese o spagnola. Protezione UV400 | Sunglasses with coloured frame available in different design recalling the colours of italian, french or spanish flag. Black lenses. UV400 protection

Plastica | Plastic

15 x 16,5 x 4 cm



43208
Avello

Custodia per occhiali. Chiusura a coulisse | Pouch for glasses. Closure by draw-string.

Poliestere | Polyester

9 x 18 cm



Occhiali non inclusi | Sunglasses not included



.08



.01 .02 .23 .17
.06 .07 .04



13007
Zimmy

Cappello in poliestere con confortevole nastro interno | Polyester hat with comfortable inside ribbon.

Poliestere | Polyester

Size 58 cm



.00



13023
Atrato

Cappellino con confortevole fascia interna. | High quality synthetic fiber hat with inner comfort band.

Fibra sintetica | Synthetic fiber

Size 59



.00



13025
Azoto

Cappello a tesa larga con confortevole fascia interna | Flat-brimmed hat made of synthetic material with inner comfort band.

Materiale sintetico | Synthetic material

Size 59



.00

.13



13022
Nanto

Cappello a tesa corta, unisex | Short brim hat in an unisex design.

Carta | Paper

Size 59 cm



.00

.13



13017
Stiniva

Cappello panama unisex | Short brim hat in flexible straw.

Paglia Morbida | Soft Straw

Size 59



RIBBONS FOR STRAW HAT
ITEM 14001



.01

.00



13024
Attinio

Cappellino in materiale sintetico con confortevole fascia interna. | Synthetic material hat with inner comfort band

Materiale sintetico | Synthetic material

Size 59





SUMMER HATS

In straw or paper.



CUSTOMIZE YOUR STYLE WITH COLORFUL HAT BANDS



14001
Sticky

Nastro per sombrero | Ribbon for straw hat
TNT No-woven | TNT No-woven
67 x 2,7 cm



13002
Musa

Cappello da spiaggia con un pannello in poliester. | Foldable straw hat perfect for the beach, in soft straw with a polyester panel.
Paglia | Straw
19 x 15,5 x 3 cm



13000
Gosse

Cappello in paglia con nastro interno | Straw hat with comfortable inside ribbon
Paglia | Straw
Size 59



13018
Catedrais

Cappello panama unisex | Short brim straw hat.
Paglia | Straw
Size 59



13101
Appaftig

Cappello in carta con fascetta cucita | Paper hat with stitched ribbon.
Carta | Paper
Size 57, 59



13019
Giovo

Cappello panama con nastro interno regolabile, per adattarlo ad ogni misura. | Hat with inner adjustable tape to adapt to the correct size.
Paglia | Straw
Size 59



13095
Gisbert

Cappello di paglia in colore naturale con confortevole nastro interno | Straw hat in natural greenish colour
Paglia | Straw
Size 59



13100
Grezzago

Cappello di paglia in colore naturale con confortevole nastro interno | Straw hat with comfortable inside ribbon
Paglia | Straw
Size 59

YOUR BESPOKE STRAW HAT



- 1 **Seleziona il tuo modello preferito e la tua taglia !**
Select your favourite model and size!
- 2 **Scegli il colore del nastro**
Pick the band colour
- 3 **Applica il tuo logo in base alle tue esigenze**
Put your logo based on your needs



13026
Vicentina

Cappello con fascia regolabile all'interno. | Hat with adjustable band inside.

Carta | Paper

Size 59



NEW



14058
Dueville

Fascetta per cappello sombrero | Sombrero hat band

Cotone | Cotton



.01

NEW



.13



13027
Minerbe

Cappello con fascia regolabile all'interno. | Hat with adjustable band inside.

Carta | Paper

Size 59



NEW

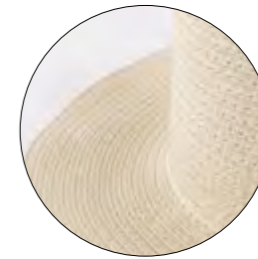



.18 .29 .08



.07



50004
Erkan

Infradito da spiaggia | Floral flip flop

Eva | Eve

Size 39



.01



50041
Aster

Infradito per sublimazione | Sublimation flip flops

Eva | Eve

Size 39/43



SIZE 25-46



.05 .31
.78 .60
.28 .88

SIZE 35-46



.54 .55
.01 .17
.02



R8305
Lyles

Zoccoli di massimo comfort, con fori di ventilazione e cinturino per il tallone a doppia posizione. | Comfortable clogs with vent holes and pivoting heel strap, with two positions.

100% EVA | 100% EVA

Size 35/46



FLIP-FLOPS MADE OF EVA

Pair of flip-flops with soles in resistant EVA and with matching color PVC straps.



.17 .06 .02 .01 .07 .04 .23

SIZE 37-39 | 42-44



50002
Jamie

Paio di infradito con fascette colorate coordinate in PVC. | Pair of flip-flops with matching colour PVC straps.

Eva, Pvc | Eva, Pvc

Size 37/39 - 42/44



.08



14038
Basilico

Asciugamano pareo, grazie alla sua dimensione può essere usato da due persone. | Pareo hand Towel, its large size allows it to be used by two people comfortably.

Cotone | Cotton

180 x 180 cm



14039
Berberé

Pareo con disegno etnico, disponibile in 3 diversi colori tra cui scegliere | Pareo with a ethnic design in three different colours to choose.

Cotone | Cotton

100 x 180 cm

ORIGINAL BICOLOUR BEACH TOWELS

Pareo towel comfortable for two.

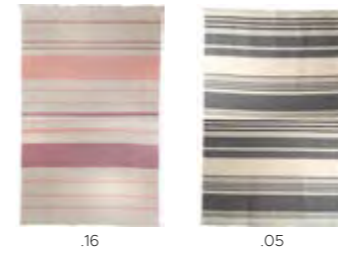

14035
Baharat

Asciugamano foutah, con righe applicate tinte in filo | Yarn dyed weft foutah towel (peshtemal)

100% Cotone | 100% Cotton

100 x 150 cm

340 gr/m²



18058
Chiuta

Asciugamano pareo, doppia finitura, un lato in morbido cotone e l'altro con effetto vellutato. Con frange corte sui bordi. | Towel pareo, made of fabric with two faces, one of soft cotton, and the other part towel with ultra velvety effect. With short fringes.

Cotone | Cotton

90 x 180 cm + Fringes

300 gr/m²



14036
Bario

Asciugamano pareo, realizzato con spugna su un lato e frange annodate | Pareo towel, made with curl on one side and knotted fringes.

100% Cotone - 220gr/m² | 100% Cotton - 220gr/m²

160 x 80 cm

220 gr/m²



14044
Boro

Asciugamano pareo con i lati in due diversi tessuti, un lato in french terry. | Pareo towel with sides in two different fabrics

100% Cotone - 340gr/m² | 100% Cotton - 340gr/m²

90x160cm

340 gr/m²



CHOOSE YOUR PANTONE COLOR



.13



14046
Cadmio



Set pareo con borsa in cotone coordinata con lo stesso design. | Cotton pareo set with cotton bag of the same material

100% Cotone - 220gr/m2 | 100% Cotton - 220gr/m2

📏 Borsa: 44 x 36 cm / Pareo: 95 x 175 cm

220
gr/m²



.05

.19

.08



.13



14201
Assi



Asciugamano pareo stile classico. Color natural con dettaglio colorato e frange. | Pareo towel in classic style. Natural colour with coloured details and fringe finishing.

100% Cotone | 100% Cotton

📏 90 x 180 cm

185
gr/m²



.13



14045
Bromo



Coperta con piccole frange decorative | Blanket with small decorative trimmings

Cotone - 160 gr/m2 | Cotton - 160 gr/m2

📏 140 x 190 cm

160
gr/m²



.05

.13



.08



14057
Mestrino



Pareo con frange decorative. | Sarong with decorative fringes.

Cotone riciclato, Poliestere - 140 gr/m2 | Recycled Cotton, Polyester - 140 gr/m2

📏 90 x 170 cm

140
gr/m²



.40



18088
Orsago



Asciugamano made in Europe. | Towel made in Europe.

Cotone Fairtrade - 300 gr/m2 | Fairtrade cotton - 300 gr/m2

📏 70 x 140 cm

300
gr/m²



.13



14059
Grisignano



Foulard pareo in cotone Fairtrade 85 gr/m2, dimensione di 50 x 170 cm. Con frange decorative. | Pareo scarf in Fairtrade cotton 85 g/m2, size 50 x 170 cm. With decorative fringes.

Cotone Fairtrade - 85 gr/m2 | Fairtrade cotton - 85 gr/m2

📏 50 x 170 cm

85
gr/m²





.18 .08 .27



.06 .08 .27 .13



.05 .03



.05



.05



.13

.18



14043
Bohrio

Asciugamano pareo con frange annodate | Pareo Hand Towel with knotted fringes

100% Cotone - 180gr/m2 | 100% Cotton - 180gr/m2

180 x 90cm



14614
Rosier

Asciugamano pareo con un lato finitura terry. | Pareo with towel and terry finishing

Cotone, Poliestere | Cotton, Polyester

90 x 180 cm + Fringes



1st side 2nd side



14047
Francio

Asciugamano pareo con frange annodate. | Pareo towel without curl

100% Cotone Organico | 100% Organic Cotton

90 x 180 cm



14048
Gadolinio

Asciugamano pareo senza spugna | Recycled cotton towel pareo without sponge

Cotone riciclato - 160 gr/m2 | Recycled cotton - 160 gr/m2

90 x 185 cm

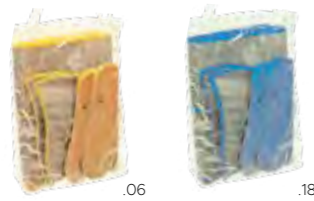

.06 .18



.17 .18 .29



.07 .08 .23



.07 .08 .06 .05



.17



.07



.04



.19



50010
James

Borsa mare con stuoia, infradito in gomma e cappello in paglia. | Beach bag with beach straw mat with flip flop and straw hat

Pvc | pvc

34 x 32,7 x 9,4 cm



50012
Riley

Borsa mare con ciabatte in gomma e stuoia | Beach bag with straw mat and flip flop

Paglia | Straw

35 x 30 x 6 cm - 180 x 90 cm



18055
Plano

Morbido asciugamano ultra assorbente | Soft towel in ultra absorbent and soft microfiber.

Microfibra - 300 gr/m2 | Microfibre - 300 gr/m2

150 x 70 cm



14514
Amarillo

Asciugamano disponibile in diversi colori, con cuciture sui bordi. | Towel available in different colors, with seams on the edges.

80% Poliestere, 20% Poliammide - 400 gr/m2 | 80% Polyester, 20% Polyamide - 400 gr/m2

76 x 150 cm



BEACH UMBRELLA

Beach umbrella of 8 panels in resistant nylon, silver-grey inside with UV protection.



140x70 cm

80x40 cm

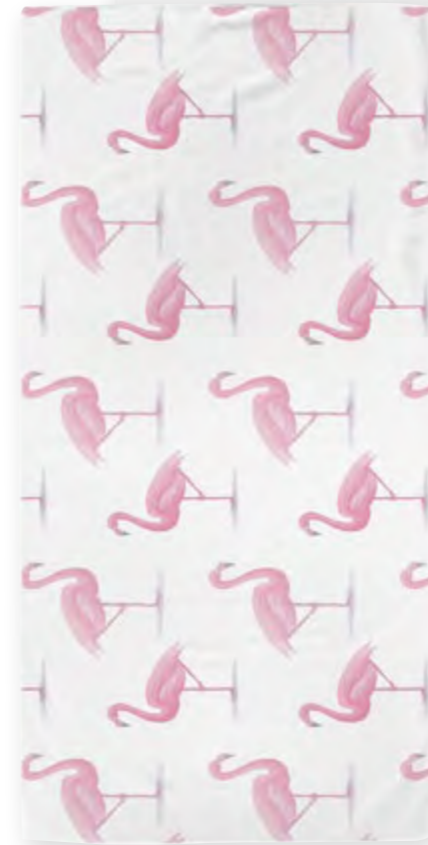

.02



.02



.05



.06

.17

.08

.07

.04



92952
Lilo

Ombrellone da spiaggia con interno silver con protezione UV. Asta centrale in metallo bianco. Regolabile in altezza. Fornito in custodia con tracolla. | Beach umbrella, silver-grey inside with UV protection. Metal coated tubes in white colour. Adjustable in height and presented in a nylon sleeve with shoulder strap.

Poliestere | Polyester

☐ 150 cm

8
PAN



18130
Vörda

Asciugamano adatto per essere sublimato sull'intera superficie. | Towel, suitable to be sublimated in all its surface

Poliestere - 200gr/m2 | Polyester - 200gr/m2

☐ 70 x 140 cm

200
gr/m²



18511
Iguaque

Asciugamano adatto per essere sublimato sull'intera superficie. | Towel, suitable to be sublimated in all its surface

80% Poliestere, 20% Poliammide | 80% Polyester, 20% Polyamide

☐ 40 x 80 cm

200
gr/m²





80x40 cm



.02



18873
Gauri



Asciugamano piccolo. Ideale per la personalizzazione in sublimatico | Small towel special for sublimation marking in all the surface.

RPET | RPET

40 x 80 cm



80x40 cm



.02



18073
Pachira



Asciugamano prodotto in Europa, ideale per la stampa in sublimazione. | Towel made in Europe and suitable for sublimation printing.

RPET, microfibra 67%, Poliestere 33% | RPET, Microfiber 67%, Polyester 33%

80 x 40 cm



150x75 cm



.02



18072
Guzmania



Asciugamano prodotto in Europa e adatto alla stampa in sublimazione | Towel made in Europe and suitable for sublimation printing.

Microfibra RPET 67%, Poliestere 33% | RPET Microfiber 67%, Polyester 33%

150 x 75 cm



140x70 cm



18980
Bardonecchia



Asciugamano grande. Ideale per la personalizzazione in sublimatico | Big towel special for sublimation marking in all the surface.

RPET | RPET

70 x 140 cm



.02



BEACH TOWELS MADE OF RPET

Special for
sublimation.

SPECIAL BEACH CHAIRS

bespoke
expert in special productions



Enjoy the good weather and free time with our chairs!

Natural wooden beech material with removable 100% polyester cover, suitable for digital printing. Easy to fold and store.



51015
Laguna

Sedia da spiaggia con personalizzazione | Laguna beach chair with printing

Legno | Wood

122 x 60 x 4 cm

Composition:
100% Natural wooden beech material

Digital printed seat mat fabric



51016
Double Laguna

Sedia da spiaggia doppia seduta con personalizzazione | Double seated laguna beach chair with printing

Legno | Wood

124 x 120 x 4 cm



UP TO 150Kg WEIGHT



51018
Fishing

Sedia da pesca con personalizzazione | Fishing chair with printing

Legno | Wood

55 x 32 x 7 cm



#EASY TO FOLD



51019
Mini

Mini sedia con personalizzazione | Mini chair with printing

Legno | Wood

65 x 35 x 5,5 cm



51017
Director

Sedia regista con personalizzazione | Director chair with printing

Legno | Wood

53 x 87 x 40 cm



UP TO 150Kg WEIGHT



bespoke
expert in special productions



17243
Dolce

Borsa impermeabile in resistente ripstop nylon. Sistema di chiusura stagno con clic. Moschettone e tracolla regolabile per il trasporto. | Waterproof bag with watertight closure system with click. Carabiner and adjustable shoulder strap for carrying.

Nylon ripstop | Rip-stop nylon
31 x 46 x Ø 20,5 cm



17311
Rémi

Borsa impermeabile in morbido ripstop con chiusura di sicurezza stagna. Tasca per il cellulare. Manico con chiusura con fibbia e moschettone incluso. | Waterproof bag in soft and resistant ripstop material with watertight security closure. Click-lock handle with carabiner closure.

Ripstop | Ripstop
Ø 11,5 x 29,5 cm



17188
Mulenda

Borsa impermeabile in morbido e resistente ripstop con chiusura di sicurezza stagna. Manico con chiusura con fibbia e moschettone incluso. | Waterproof bag in soft and resistant ripstop with watertight security closure. Handle with button lock with carabiner

Ripstop | Ripstop
36 x Ø 18,5 cm



51108
Hilda

Borsa termica adatta a contenere 6 lattine, scomparto con chiusura zip, pratica maniglia per il trasporto. | Cooler bag suitable for 6 cans, compartment with zip closure, practical carrying handle.

TNT No-woven, Alluminio | TNT No-woven, Aluminium
20 x 14 x 13 cm



51001
Agoy

Borsa termica per 6 lattine. Interno isoteramico. Con cerniera e tracolla. | Cooler bag of 6 cans in resistant PVC. Isothermal inside in aluminium finish. With zipper and carrying handle in matching colour.

Pvc, Alluminio | Pvc, Aluminium
20 x 15 x 15 cm



COOLER BAGS WITH ZIP CLOSURE

Suitable for 6 cans.





.23

.01



.08



51007
Sapodilla

Borsa termica con due scomparti con cerniera. Tracolla regolabile, con moschetto, manico imbottito colorato | Multi purpose cooler bag in resistant 600D polyester, two independent zippered compartments. With 2 front pockets and elastic mesh pocket at the back. With stretchable shoulder strap with carabiner closure and matching colour padded shoulder brace.

Poliestere 600D, Pvc | 600D polyester, PVC

25 x 24 x 15 cm



.19

.07

.23

.01



.02

.05

.08



51031
Saonara

NEW

Borsa frigo con due scomparti, uno refrigerante (piccolo) e uno termico (grande). Chiusura con zip, tracolla regolabile. | Cooler bag with two compartments, one cooling (small) and one thermal (large). Zip closure, adjustable shoulder strap.

Poliestere | Polyester

30 x 20 x 25 cm



COOLER BAGS

With practical front pocket.



.04

.01

.23

.08



51029
Pontecchio

NEW

Borsa termica. Tasca principale isotermica e pratica tasca frontale. Tracolla regolabile. | Thermal bag. Insulated main pocket and practical front pocket. Adjustable shoulder strap.

Poliestere 600D | 600D polyester

26 x 34 cm





.01 .06 .07 .08



.04 .18 .17 .24



.23



51786
Belterra

Borsa mare termica in con interno isothermico. Chiusura con zip e manici lunghi rinforzati. | Cooler beach bag with isothermal inside. Zipper closure and long reinforced handles.

TNT No-woven - 80gr/m2, Alluminio | TNT No-woven - 80gr/m2, Aluminium

29 x 20 x 10 cm



.08 .06 .01 .04



.23



51030
Rizza



Borsa termica pieghevole. Fodera in alluminio isothermico e chiusura con cerniera. Manici rinforzati. Facile da ripiegare, richiudibile con la cerniera. | Foldable thermal bag. Isothermal aluminum lining and zip closure. Reinforced handles. Easy to fold, resealable with zip.

Poliestere 190T | 190T polyester

45 x 36 cm



.05 .01



64329
Vedelago



Zaino termico. Fodera isothermica nello scomparto principale. Tasca nella patella. Tasche laterali a rete. Schienale e spallacci imbottiti. | Thermal backpack. Isothermal lining in the main compartment. Pocket in the flap. Side mesh pockets. Padded back and shoulder straps.

RPET | RPET

30 x 43 x 15 cm

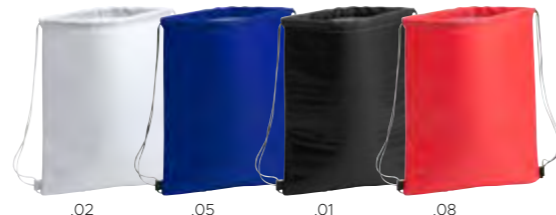

.02 .05 .01 .08

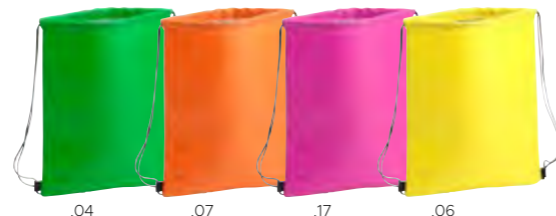

.04 .07 .17 .06



51150
Mammut

Sacca termica. Chiusura con coulisse e angoli rinforzati. | Drawstring cooler backpack. With black self closing ropes and reinforced corners.

Poliestere 210D, Alluminio | 210D Polyester, Aluminium

32 x 42 cm



.23 .18 .03



64330
Viro



Zaino termico. Fodera isothermica nelle tasche principali e in quelle anteriori. Scomparto anteriore con cordino elastico e tasche laterali a rete. Schienale e spallacci imbottiti. | Thermal backpack. Isothermal lining in main and front pockets. Front compartment with bungee cord and side mesh pockets. Padded back and shoulder straps.

Poliestere Ripstop 210D | 210D Ripstop Polyester

26 x 40 x 19 cm



COOLER BACKPACKS

With side mesh pockets.



.04

.08

.07



51028
Lambda



Borsa termica per 6 lattine. Interno isotermico. Cerniera e maniglia colorate coordinate. | Cooler bag of 6 cans. Isothermal inside. Matching color zipper closure and handles.

TNT No-woven RPET, Alluminio | TNT No-woven RPET, Aluminium

21 x 15 x 15 cm



.23



.03



.03



.05



.05



51025
Ittrio



Borsa termica finitura melange. Scomparto principale con zip. Tasca frontale aperta. Dotata di tracolla regolabile. | Thermal bag with vigore design. With isothermal front and inner pocket

Poliestere riciclato RPET | RPET recycled polyester

25 x 15,5 x 14,5 cm



51026
Kappa



Borsa termica extra large finitura melange. Doppio scomparto termico con chiusura zip. Tasca frontale aperta. Interno isotermico. Dotata di tracolla regolabile. | Extra large thermal bag with vigore design. Double compartment and front pocket.

Poliestere riciclato RPET | RPET recycled polyester

30 x 20 x 25 cm



.03



.03



51023
Fluoro



Borsa termica con interno isotermico, ampio scomparto principale con chiusura a zip. Tasca frontale con rivestimento termico, con chiusura zip. | Cooler bag with isothermal interior, large main compartment with zip closure. Front pocket with thermal lining, with zip closure.

RPET 600D, Alluminio, PEVA | RPET 600D, Aluminium, PEVA

26 x 22 x 11 cm



51020
Fieno



Borsa termica con rivestimento interno termico. Scomparto superiore molto capiente con chiusura a U con zip. Scomparto inferiore con chiusura zip. Tasca frontale con zip. Tracolla regolabile. | Thermal bag with thermal lining. Very large upper compartment with U-shaped zipped closure.

RPET 600D, Alluminio, PEVA | RPET 600D, Aluminium, PEVA

28 x 27,5 x 21,5 cm



RPET ISOTHERMAL BAGS AND BACKPACKS

Very large upper compartment with U-shaped zipped closure.

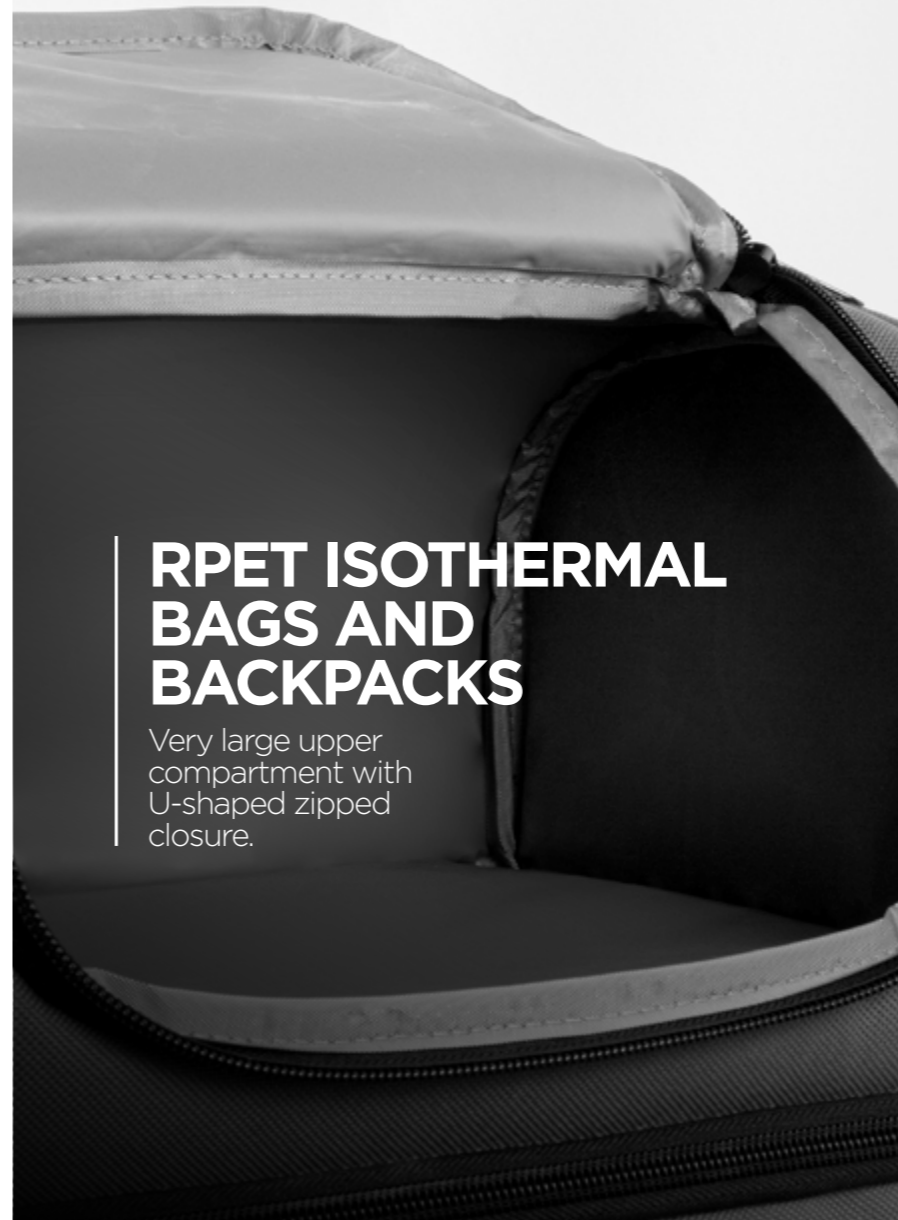



.13



75057
Nano



Borsa termica con chiusura in velcro e interno in PEVA laminato. | Thermal bag with velcro closure

65% Poliestere RPET, 35% Cotone, PEVA | 65% Polyester RPET, 35% Cotton, PEVA

18 x 13 x 33 cm



.13

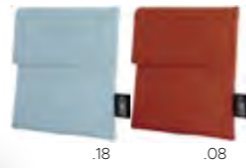

75056
Fosforo



Borsa termica con chiusura in velcro e interno in PEVA laminato. | Thermal bag with velcro closure

65% Poliestere RPET, 35% Cotone, PEVA | 65% Polyester RPET, 35% Cotton, PEVA

17 x 17 cm



.04 .02 .08 .23



75059
Chiarano



Porta sandwich riutilizzabile con chiusura in velcro. Facile da pulire. Etichetta RPET all'esterno. | Reusable sandwich holder with velcro closure. Easy to clean. RPET label on the outside.

Poliestere riciclato RPET, Peva isothermico | RPET recycled polyester, isothermal Peva

18 x 18 cm



75058
Chies



Porta sandwich realizzato in carta laminata con chiusura zip. Interno in alluminio isothermico. Dotato di pratico manico per il trasporto. | Sandwich holder made of laminated paper with zip closure. Isothermal aluminum interior. Equipped with a practical carry handle.

Carta Laminata, Alluminio | Laminated Paper, Aluminum

21 x 8 x 7,5 cm



.13



.02 .01 .08
.04 .06 .23



75060
Costermano



Porta sandwich con chiusura con zip. Dotato di pratico manico per il trasporto. | Sandwich holder with zip closure. Equipped with a practical carry handle.

Pvc, Alluminio isothermico | PVC, isothermal aluminium

21 x 8 x 7,5 cm





.13



51014
Buba



Borsa Frigo realizzata in iuta laminata resistente all'umidità, cerniera in tinta. Manici in cotone. Tasca esterna in cotone. | Cooler bag made of moisture resistant laminated jute and matching zip. Cotton handles and outer pocket made in cotton

Juta Laminato, Cotone, Alluminio | Laminated Jute, Cotton, Aluminum

21 x 23 x 16 cm



.13



51785
Belsk



Borsa termica. Interno isotermico. Tasca esterna, chiusura in velcro. | Thermic bag, isothermal inside, with outside pocket and velcro closure.

Carta, Alluminio | Paper, Aluminum

19 x 32 x 12 cm



.13



51013
Bruno



Borsa termica con interno in alluminio isotermico. Manico da 60 cm e 3 l di capacità. Patta con chiusura a zip e pratica maniglia per il trasporto. | Cool box with isothermal aluminium lining . 60 cm long handle and 3 l. capacity. Flap with zip fastening and practical carry handle.

Carta kraft, alluminio, schiuma - 130 gr/m2 | Kraft paper, aluminium, foam - 130 gr/m2

19 x 14 x 13,5 cm



.13



51021
Flerovio



Borsa termica con interno isotermico, tasca frontale con chiusura con velcro | Thermal bag with isothermal interior, front pocket with velcro closure.

PP, Juta Laminata, Cotone, Alluminio - 320 gr/m2 | PP, Laminated Jute, Cotton, Aluminum - 320 gr/m2

43 x 20 x 34 cm



.13



51022
Sirena



Borsa termica con interno isotermico, tasca frontale con chiusura con velcro | Thermal bag with isothermal interior, front pocket with velcro closure.

PP, Juta Laminata, Cotone, Alluminio - 320 gr/m2 | PP, Laminated Jute, Cotton, Aluminum - 320 gr/m2

25 x 15 x 22,5 cm

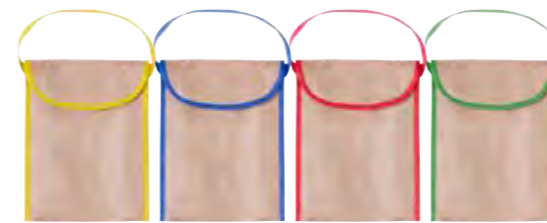

.06

.23

.08

.04



51169
Este



Borsa termica con dettagli colorati. Interno isotermico con finitura in alluminio, con manico colorato coordinato. | Cooler bag, with coloured details. Isothermal inside in aluminium finish, with matching colour carrying handle.

Carta Laminata, Alluminio | Laminated Paper, Aluminum

20 x 25 x 10 cm



BEACH BAG

Made of jute and cotton.
Magnetic button closure.



.13



54063
Crinum

Sacca con base in Jute e corpo in cotone naturale. Chiusura a strozzo con corda. | Bag with Jute base and natural cotton body. Choke closure with rope.

Juta, Cotone | Jute, Cotton

44 x 42 x 12,5 cm



.18



.19



.08



64536
Speziell

Sacca zaino con coulisse e tasca frontale in cotone. | Drawstring bag in jute with cotton front pocket.

Juta, Cotone | Jute, Cotton

39,5 x 37,5 cm



.19



.08



.18



55089
Sprutt

Sacca mare con tasca frontale aperta, chiusura con coulisse e tracolla regolabile. | Beach bag with open pocket on front, drawstring closure and adjustable shoulder strap

Juta, Cotone | Jute, Cotton

37 x Ø 28 cm



55790
Stabil

Sacca mare, manici lunghi rinforzati in cotone. Chiusura con bottone magnetico. | Beach bag with long reinforced handles in cotton material in natural colour. Magnetic button closure

Juta, Cotone | Jute, Cotton

53 x 39 x 19,5 cm



.13



54045
Meolo



Borsa in juta con manici lunghi e interno laminato. | Jute bag with long handles and laminated interior.

Juta | Jute

32 x 16 x 39,5 cm



54046
Moriago



Borsa con manici lunghi in corda. | Bag with long rope handles.

Cotone Fairtrade - 280 gr/m² | Fairtrade cotton - 280 gr/m²

45 x 10,5 x 38 cm

280 gr/m²



54047
Pastrengo



Borsa da spiaggia con doppi manici, corti e lunghi, dotata anche di coulisse per la chiusura. | Beach bag with double handles, short and long, also equipped with a drawstring closure.

Tela naturale - 220 gr/m² | Natural canvas - 220 gr/m²

35 x 30 x 34 cm

220 gr/m²



54066
Roncà



Borsa mare color natural, ampio scomparto principale, tasca frontale aperta. Manici lunghi rinforzati. | Beach bag in natural color, large main compartment, open front pocket. Reinforced long handles.

Cotone riciclato - 140gr/m² | Recycled cotton - 140gr/m²

50 x 38 x 15 cm

140 gr/m²



54070
Sarego



Borsa mare con frange decorative sui bordi, ampio scomparto principale con chiusura con zip, tasca interna con zip, manici rinforzati in contrasto. | Beach bag with decorative fringes on the edges, large main compartment with zip closure, internal zip pocket, contrasting reinforced handles.

Cotone Canvas - 450gr/m² | Cotton Canvas - 450gr/m²

36 x 32 x 19 cm

450 gr/m²



54065
Ponzano



Borsa mare finitura solida, ampio scomparto principale, tasca frontale aperta. Manici lunghi rinforzati. | Beach bag in solid finish, large main compartment, open front pocket. Reinforced long handles.

Cotone riciclato - 140gr/m² | Recycled cotton - 140gr/m²

38 x 42 cm

140 gr/m²



BEACH BAGS

With internal pocket and velcro closure.



678



54061
Ferro

Borsa shopper/mare con manici in cordura, tasca portatutto interna e chiusura a velcro | Shopping/beach bag with polyester handle, internal pocket and velcro closure

Poliestere | Polyester

60 x 36 cm

.19



.19

.23



54006
Mirl

Borsa da spiaggia con ampio scomparto principale con zip. Comprende piccolo borsellino con zip. Manici lunghi. | Beach bag with large main compartment with zipper closure. With zippered purse. Long handles.

Poliestere 600D | 600D polyester

62 x 18 x 40 cm



.07



17085
Rodew

Borsa shopping double face con chiusura a nodo. Manici lunghi | Double-sided shopping bag with knot closure. Long handles

Poliestere | Polyester

65 x 46 cm



.17

.04

.02

.23

.07

.08



54034
Rikkel

Borsa con ampio scomparto principale con chiusura zip, manici a contrasto, con borsellino con chiusura zip, colorato e coordinato. | Bag with large main compartment with zip closure, contrasting handles, with purse with zip closure, colored and coordinated.

Poliestere 600D | 600D polyester

47 x 34 x 12,5 cm



679



FANS WITH RIBS

Fans with plastic or wooden ribs and polyester fabric.



50047
Eta

NEW

Ventaglio con stecche in legno lunghezza 23cm, con tela con motivo floreale. | Fan with wooden slats length 23cm, with floral pattern canvas.

Legno, poliestere | Wood, polyester

41 x 23 cm



50057
Maden

Ventaglio con stecche in legno e tessuto in poliestere. | Fan with ribs in natural wood and polyester fabric.

Stecche In Legno | Wooden slats

43 x 23 cm



50068
Ramon

Ventaglio con stecche in plastica e tessuto in poliestere. | Fan with plastic ribs and polyester fabric.

Stecche in Plastica | Plastic slats

41 x 23 cm



50112
Cosizza

Ventaglio | Hand Fan with wooden ribs and RPET fabric.

Legno, Poliestere Rpet | Wood, Polyester Rpet

42,5 x 23 cm



50116
Palù

NEW

Ventaglio con bacchette in legno | Fan with wooden sticks

Legno, tessuto | Wood, fabric

42,5 x 23 cm



50115
Montorso



Ventaglio con bacchette in legno | Fan with wooden sticks

Legno, Cotone | Wood, Cotton

42,5 x 23 cm



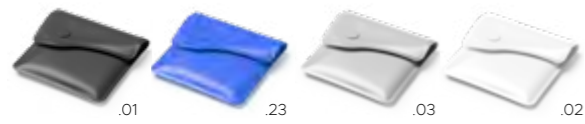

.01 .23 .03 .02



.08



59023
Columnea

Posacenere tascabile con chiusura con bottone. Interno in alluminio ignifugo. | Pocket ashtray with button closure. Fireproof aluminium inside.

Pvc, Alluminio | Pvc, Aluminum

8 x 8 x 1,1 cm



.01 .04

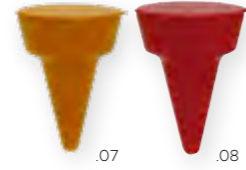

.07 .08



.05



59007
Rappi

Posacenere da spiaggia | Resistant portable ashtray.

Plastica | Plastic

Ø 6 cm



.06 .02 .08 .05



.02 .07 .01 .17 .06 .04 .05



41123
Gamalero

Pochette con chiusura zip colorata. | Large PVC Toiletry bag, transparent PVC with coloured zipper closure.

Pvc | pvc

23 x 5 x 23 cm



.08



50049
Fermio

Custodia impermeabile con cordino con stopper per la regolazione, adatta ai dispositivi touch screen. | Waterproof case with drawstring with stopper, suitable for touch screen devices.

Pvc | pvc

21 x 13 cm



.02 .01 .06 .07 .05 .08 .17



50083
Sosny

Custodia impermeabile, con superficie touch screen e doppia chiusura di sicurezza. | Waterproof bag with tactile, surface and double safety system to preserve watertightness.

Pvc | pvc

23 x 9,5 cm



.04

WATERPROOF BAGS IN PVC

PVC bag with tactile surface and double safety system to prevent water tightness.

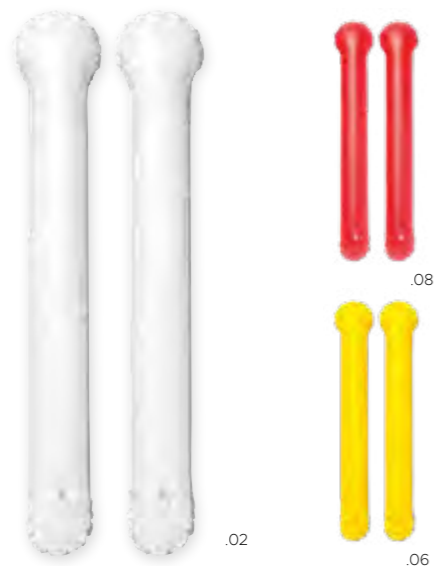

 50064
Lisbona
Bastoni gonfiabili click clack gonfiabili, a coppia | Inflatable Clack sticks, 2pcs
Pvc | pvc
9,5 x 55 cm



 50099
Tommy
Poltrona portacellulare gonfiabile | Armchair shaped inflatable mobile phone holder
Pvc | pvc
12 x 12 cm



 50098
Kipling
Cuscino gonfiabile | Inflatable pillow
Pvc | pvc
33 x 18 cm

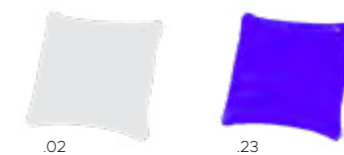

 50037
Greve
Cuscino gonfiabile | Inflatable pillow
Pvc | pvc
30 x 30 cm



 50202
Kyle
Gonfiabile 'tartaruga' | Inflatable 'turtle'
Pvc | pvc
50 cm



 50052
Jinan
Sottobicchiere gonfiabile. Realizzato per contenere i tuoi drink mentre sei al mare o in piscina. | Inflatable coaster. Made to hold your drinks while you are at the beach or in the pool.
Pvc | pvc
10,5 cm



 13008
Aneris
Cuffia da piscina. | Swimming pool cap.
Poliestere | Polyester
22 x 18 cm

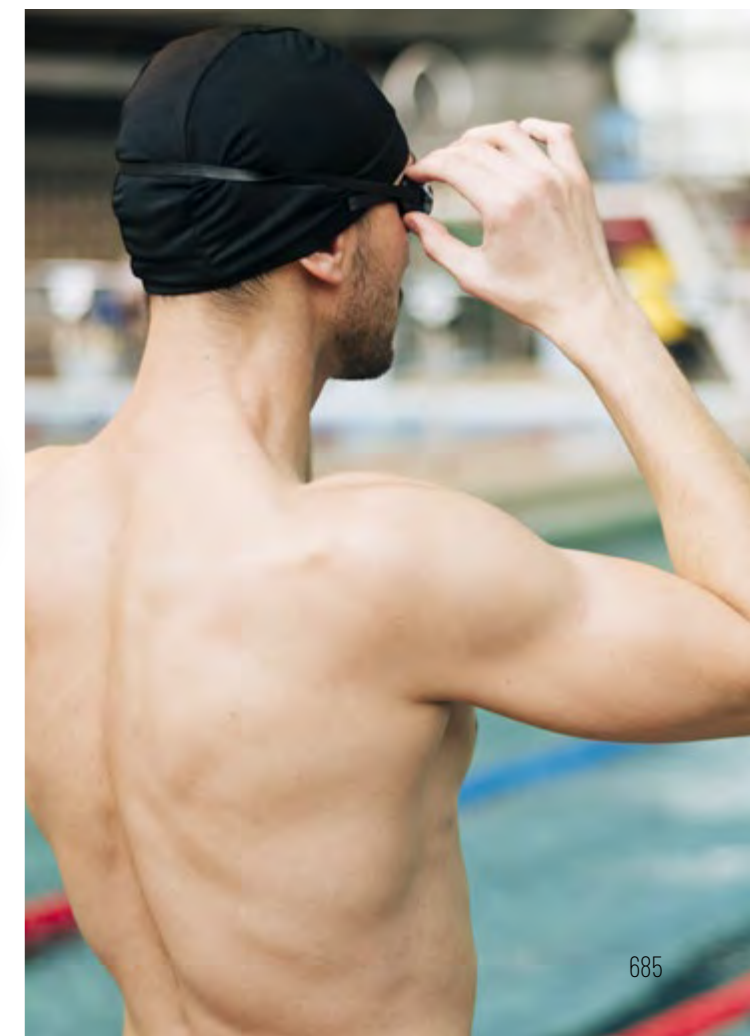

SOLID



.06

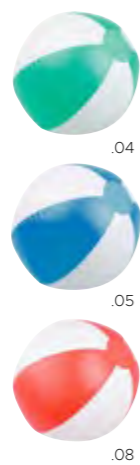

.04

.05

.08



50071

Record

Palla da spiaggia gonfiabile | Inflatable beach ball

Pvc | pvc

Deflated 37 cm - Inflated 28 cm



TRANSPARENT



.06

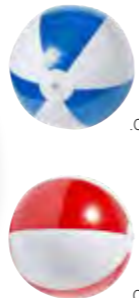

.05

.08



50547

Bjursta

Pallone gonfiabile, design bicolore, pannelli bianchi e colorati. | Inflatable balloon with bicolour design, white and transparent panels in bright tones.

Pvc | pvc

Deflated 37 cm - Inflated 28 cm

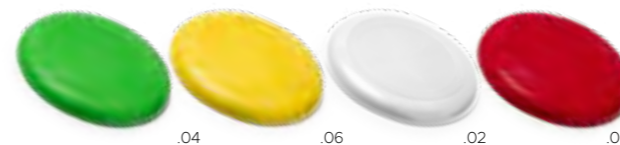

.04

.06

.02

.08



.05



50085

Downi

Frisbee | Frisbee

Plastica PP | PP plastic

Ø 23,2 cm



.40

.58

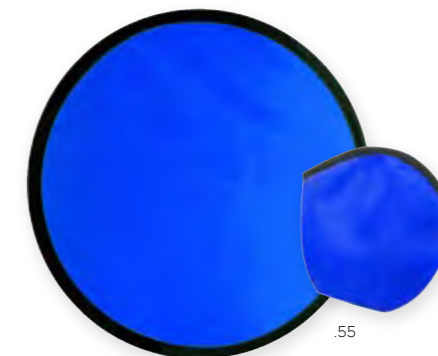

.55



50077

Flinger

Frisbee pieghevole. Fornito con pouch | Foldable frisbee. Presented in individual case.

Poliestere | Polyester

Ø 25 cm

SOLID



.06

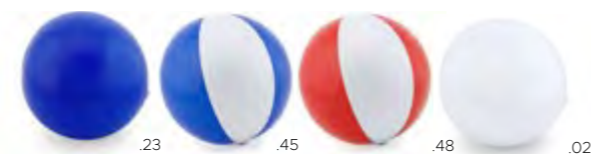

.23

.45

.48

.02

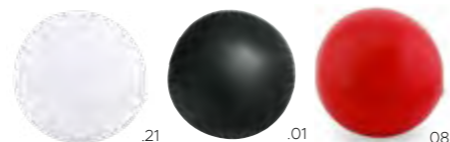

.21

.01

.08



50070

Domus

Palla da spiaggia gonfiabile | Inflatable beach ball

Pvc | pvc

Deflated 37 cm - Inflated 28 cm

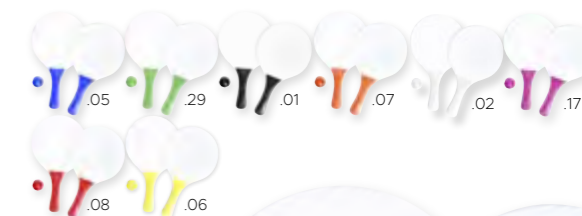

.05

.29

.01

.07

.02

.17

.08

.06



50056

Jacob

Racchette da spiaggia in legno naturale, con manici rinforzati. Fornite in borsa a rete con pallina colorata | Pair of beach rackets in natural wood with reinforced handle. Presented in a mesh bag with matching colour ball.

Legno | Wood

19 x 33 x 0,6 cm





Pets

and

Accessories

Pets and Accessories

Ciotole per cani, pieghevoli e portatili, ideali per i viaggi. Guinzagli e bandane per i nostri amici a quattro zampe.

Foldable & portable dog feeders, ideal for travel. Leashes & bandanas for our four-legged friends.



50018
Doc

NEW

Frisbee per cani con corda resistente in cotone e parte centrale in poliestere. | Frisbee for pets with resistant cotton rope and polyester core in bright tones.

Cotone, Poliestere | Cotton, Polyester

📏 Ø 19,7 cm



46941
Aden

Portachiavi riflettente giallo fluorescente, che garantisce un'elevata visibilità. Con ampio spazio di personalizzazione | Fluorescent yellow reflective key ring, which guarantees high visibility. With ample space for customization

Pvc | pvc

📏 5,5 x 4,9 cm



19010
Eket

Bandana riflettente per animali, per un'alta visibilità. Con banda riflettente, chiusura con fibbia regolabile e anello in metallo per guinzaglio. | Reflective bandana for pet in resistant and soft polyester of high visibility. With reflective band, adjustable buckle closure strap and metal accessory for belt.

Poliestere | Polyester

📏 20 x 14 cm



50048
Europio

Pallina per cani in gomma resistente e tessuto rinforzato | Dog ball made of durable rubber and reinforced fabric

Gomma, tessuto | Rubber, fabric

📏 Ø 6,4 cm



49125
Erbio

Collare regolabile per animali. Fibbia con chiusura a scatto. Include un anello di metallo per il guinzaglio da passeggio. | Pet collar made of durable, soft polyester. Adjustable strap and buckle with snap closure.

Poliestere | Polyester

📏 51 x 2,5 cm



64143
Yelshanka

Borsa shopper pieghevole con scomparto principale aperto. Ripiegabile a forma di osso. | Foldable shopping bag with open main compartment. Foldable in a bone shape.

Poliestere | Polyester

📏 35,5 x 38,7 cm





.23 .19



.08



59021
Benwld

Ciotola pieghevole per animali. Adatta a cibi solidi o liquidi, moschettone in metallo | Folding bowl for pets. Designed for solids and liquids, with metal carabiner

TPR | TPR

☐ 12,9 x 5,2 cm



.00



59025
Treviso

Ciotola richiudibile per animali domestici. Adatta per solidi e liquidi. | Resealable bowl for pets. Suitable for solids and liquids.

RPET | RPET

☐ 10 x 17 cm



.08 .23 .02



59005
Ory

Dispenser di sacchetti per animali a forma di osso. Moschettone colorato. Include 15 sacchetti. | Pets bag dispenser with bone design. Matching colour carrying carabiner and 15 bags included.

Plastica | Plastic

☐ 8,5 x 4,5 x 4,5 cm



.01 .02 .08 .18



59017
Aman

Sacchetti di ricambio per dispenser a forma di osso. 15 sacchetti. | Spare bags for bone shape dispenser. Includes 15 bags.

Plastica | Plastic

☐ 6 x 2,2 cm



.08



52046
Cycas

Borraccia con ciotola per cani. Borraccia con tappo a vite con beccuccio a pressione e cappuccio. Con gancio. 250ml | Dog water bottle with bowl. Bottle with screw on cap and push and pull spout with safety hood. With hook. 250 ml

Plastica, Pet | Plastic, Pet

☐ 21 x 5 x 5 cm



.86 .01 .88 .40
.87 .84 .85



59024
Rame

Dispenser di sacchetti per animali con moschettone coordinato. Include 15 sacchetti. | Pet bag dispenser with matching carabiner. Includes 15 bags.

Pvc | pvc

☐ 8,2 x 5,4 x 4,1 cm





Fitness and Wellness

Smartwatch multifunzione, asciugamani da palestra, attrezzi da bici e accessori sportivi, pettorine, luci riflettenti, zaini e borsoni sportivi.

Multifunctional smartwatches, gym towels, bike gear and sports accessories, bibs, reflective lights, backpacks and sports bags.



.03



57001
Veronica

Tappetino per yoga e altre attività, con manico per trasportarlo. | Mat for yoga and other activities, with handles for easy carrying.

Eva | Eve

60 x 174 cm

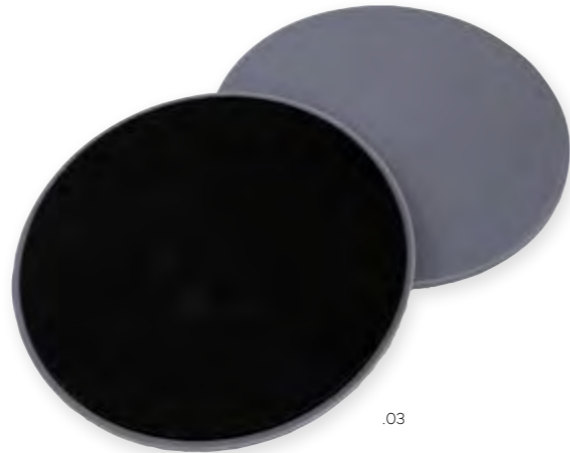

.03



57006
Rafano

Coppia di dischi scorrevoli per ginnastica per allenare diversi muscoli. | Pair of sliding gymnastics discs for training different muscles.

Abs, EVA | ABS, EVA

17,5 x 0,75 cm



.08



57102
Larry

Tappetino da yoga con pratica borsa per il trasporto. | Yoga mat with practical carrier pouch.

Pvc | pvc

60 x 180 cm



MATS FOR YOGA

Made of
natural cork

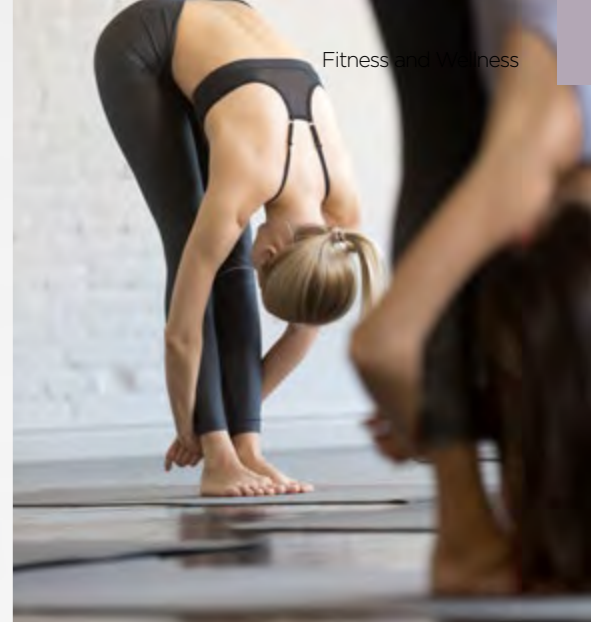

Fitness and Wellness



.00



57002
Violetta

Tappetino per yoga e altre attività, con maniglia per un facile trasporto. | Mat for yoga and other activities, with handles for easy carrying.

Sughero | Cork

61 x 183 cm





YOGA ACCESSORIES

Block for Yoga, Pilates, flexibility and balance exercises.



.00



57004
Zampa

Step per esercizi di yoga, pilates, flessibilità ed equilibrio. | Block for Yoga, Pilates, flexibility and balance exercises.

Sughero | Cork

23 x 15 x 7,5 cm



.03



57003
Ylang

Step per esercizi di yoga, pilates, flessibilità ed equilibrio. | Block for yoga, pilates, flexibility and balance exercises.

Eva | Eve

23 x 14,5 x 8 cm



.23

.04



.08



95750
Sissi

Corda per saltare con manico in legno, lunghezza adatta per adulti e per bambini. | Jump rope with a wooden handle and length suitable for both adults and children.

Legno, poliestere | Wood, polyester

260 cm



.00



95117
Tulio

Corda per saltare con manici in legno liscio. | Cotton jump rope with smooth wooden handles

Cotone, legno | Cotton, wood

17 x 13 x 5,5 cm



.01



18078
Officinalis

Attrezzo elastico per allenamento braccia, morbida impugnatura. | Elastic arm training tool, with soft grip.

TPE, NBR | TPE, NBR

35 x 10,5 cm



.01



95118
Uranio

Corda tecnica per saltare regolabile. Fornita in pouch con coulisse. | Adjustable technical jump rope. Includes a drawstring bag.

Acciaio (e altre leghe in metallo) | Steel (and other metal alloys)

300 x 14,5 cm

YOGA GAME AND ELASTIC BANDS

Yoga game made of pine wood, with 4 dices showing 5 different yoga postures each, plus a symbol. Includes cotton bag.

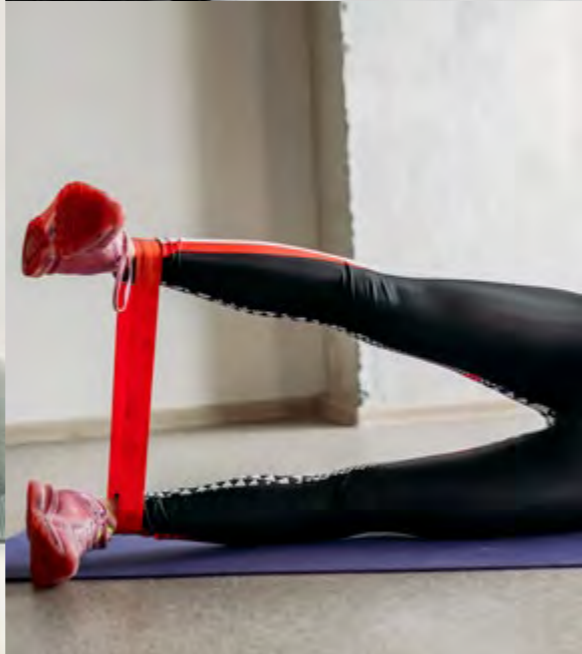
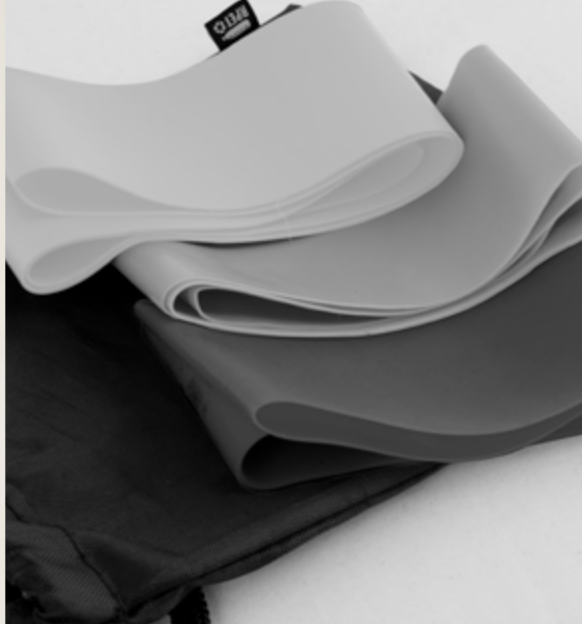

95113
Acmea



Set dadi, composto da 4 dadi che rappresentano ciascuno 5 diverse posture yoga, più un simbolo. Include un sacchetto di cotone. | Yoga game, with 4 dice showing 5 different yoga postures each, plus a symbol. Includes cotton bag.

Legno di pino | Pine wood

5 x 5 x 2,5 cm



.00

RECYCLED PLASTIC



.03



18081
Omicron



Set di 3 fasce elastiche, di diversa resistenza, leggera, media e forte. Fornito in una pouch con chiusura con bottone a pressione. | Set of 3 elastic bands of light, medium and strong resistance.

TPE, Poliestere RPET | TPE, Polyester RPET

Fasce: 30 x 5 cm / Borsa: 12 x 19 cm

RECYCLED PLASTIC



.03



18080
Olmio



Fascia elastica di media resistenza, fornita in una pouch in rpet con chiusura con coulisse. | Elastic band of medium resistance, presented in a bag with adjustment closure.

TPE, Poliestere RPET | TPE, Polyester RPET

Fascia: 150 x 15 cm / Borsa: 12 x 19 cm

LIGHT MEDIUM STRONG



.09



18069
Cola

Set di elastici sportivi. Comprende 3 bande 30x5 cm realizzate in TPE resistente con 3 livelli di resistenza. Fornito con custodia con coulisse. | Set of elastic bands, includes 3 bands, 3 levels of resistance, in a polyester pouch with a drawstring closure

TPE | TPE

9 x 22 x 1 cm



18077
Noce

Fascia elastica per saltare, 4 metri di lunghezza. Fornita in pouch di cotone. | Elastic band to jump, 4 meters length. Presented in a cotton bag.

Gomma, cotone | Rubber, cotton

Borsa: 8 x 13 cm / Gomma: 4 m



.13



18086
Cork

Asciugamano multisport. Leggero, compatto e facile da trasportare. Asciugatura rapida. Elastico per la chiusura. | Multisport towel. Lightweight, compact and easy to carry. Quick drying. Elastic for closure.

90% poliestere, 10% poliammide - 190 g/m² | 90% polyester, 10% polyamide - 190 gr/m²

70 x 120 cm

190 gr/m²

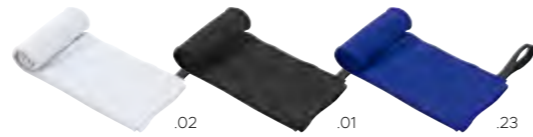

18062
Cleopatra

Asciugamano in microfibra con pratica custodia con moschettone. | Refreshing microfiber towel. Presented in a practical case with carabiner.

Poliestere | Polyester

Towel: 30 x 30 cm - Case: 5,5 x 7 x 3 cm



**SPORT TOWELS
FOR ALL KIND
OF ACTIVITIES**

Microfiber towel with elastic band for an easy folding. Made of recycled plastic



18074
Agapetes

Asciugamano in microfibra con elastico per una facile piegatura. | Microfiber towel with elastic for easy folding.

Poliestere 65% RPET | Polyester 65% RPET

80 x 130 cm





18052
Poltsamaa

Asciugamano, fornito in pratica custodia a rete con chiusura regolabile. | Towel presented in a practical mesh bag with adjustable accessory.

Microfibra - 185 gr/m2 | Microfibre - 185 gr/m2

100 x 50 cm

185 gr/m²

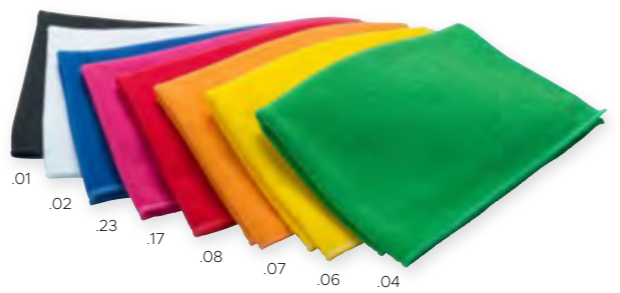
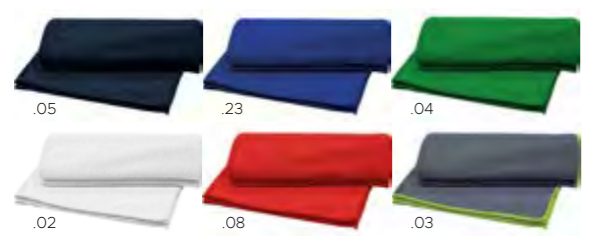

18085
Noemi

Piccolo telo realizzato con cucitura decorativa sui bordi. Elastico di chiusura | Small towel with decorative stitching on the edges. Elastic closure

80% Poliestere / 20% Poliammide - 280 gr/m2 | 80% Polyester / 20% Polyamide - 280 gr/m2

38 x 68 cm

280 gr/m²



18049
Poipet

Piccolo asciugamano. Fornito in custodia in pvc. | Hand towel presented inside a PVC bag.

Microfibra - 345 gr/m2 | Microfibre - 345 gr/m2

45 x 30 cm - Bag: 17,5 x 14,5 cm

345 gr/m²

SPECIAL TOWEL FOR SUBLIMATION

One side polyester and the reverse in terry cotton.



18079
Oganessio

Asciugamano bianco particolarmente adatto per la sublimazione. Un lato in poliestere e un lato in spugna di cotone. | Special white towel for sublimation. One side polyester and the reverse in terry cotton.

45% Poliestere, 55% Cotone | 45% Polyester, 55% Cotton

140 x 70 cm

300 gr/m²



ELASTIC SPORT HEADBAND

Made of soft microfiber.



.01 .02 .06 .17 .19 .16



49128
Noland

Fascia tecnica da running in doppio tessuto | Technical running band in double fabric

Poliestere | Polyester

22,5 x 8 cm

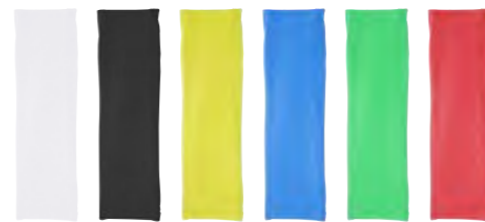

.02 .01 .06 .23 .04 .08



49112
Nogarole

Fascia elastica sportiva realizzata in morbida microfibra. | Elastic sport headband made of soft microfiber

Microfibra | Microfiber

23,5 x 6 cm



.5796 .5501 .1501 .0157
.0201 .0202 .0503 .014702
.12001 .6001 .9801 .0156
.016005 .0155 .010355



R8320
Nadal

Scarpa casual in stile retrò con punta stretta e suola in gomma. Chiusura con lacci e bande laterali decorative | Casual trainers in retro style with narrow toe, rubber sole, laces and side decorative stripes.

40% Oxford, 60% Poliestere | 40% Oxford, 60% Polyester

26/46



R8300
Biles

Classica scarpa in tela con suola in gomma bianca decorata con linee colorate. Occhielli di ventilazione laterali, punta in gomma e chiusura con lacci. | Classic canvas trainers with white rubber sole and colour stripes. Side vent eyelets, rubber toe and lace fastening.

100% Cotone | 100% Cotton

36/46



CHIUSURA CON LACCI IN TAGLIA DALLA 36 ALLA 41
LACE-UP STYLE IN SIZES FROM 36 TO 41



.01216
.0155
.0160

CHIUSURA CON VELCRO IN TAGLIA DALLA 25 ALLA 35
VELCRO FASTENING IN SIZES FROM 25 TO 35



.01216
.0155
.0160



R8315
Owens

Scarpa sportiva in stile classico, molto comoda e ideale per l'uso quotidiano. | Comfortable sports shoes in a classic design, ideal for everyday use.

Poliestere | Polyester

25/41



Crea la tua divisa su misura e personalizza il tuo sport!

Calcio, pallavolo, basket, tennis, bicicletta, rugby e molto altro...

Create your bespoke uniform and personalize your sport!

Football, volleyball, basketball, tennis, bike, rugby and much more...

BESPORTIVE

La linea SPORT BESPOKE offre ad appassionati e sportivi il massimo del comfort con il vantaggio di un capo completamente personalizzato.

Il kit nasce da un rotolo di tessuto 100% poliestere che viene prima personalizzato in sublimazione, poi tagliato a laser ed infine cucito in sartoria.

Grazie a questo processo, è possibile realizzare capi unici che grazie al tessuto 100% poliestere a fibra elastica avranno colori sgargianti e duraturi (anche dopo diversi lavaggi), ma anche una perfetta aderenza al corpo, per movimenti fluidi e funzionali.

The BESPOKE SPORT line offers passionate sportspeople maximum comfort with the great advantage of a completely customized garment.

The kit comes from a roll of 100% polyester fabric that is first personalized in sublimation, then laser cut and finally carefully sewn.

Thanks to this process, it is possible to create unique garments that, thanks to the 100% polyester fabric and elastic fiber, will have bright and long-lasting colors (even after several washes), but also a perfect adherence to the body, for fluid and functional movements.

bespoke
expert in special productions



FOOTBALL UNIFORM



CREWNECK SWEATSHIRT



TENNIS UNIFORM



HOODED SWEATSHIRT



RUGBY UNIFORM



BASKETBALL UNIFORM



RUNNING



BICYCLE



HOODED SWEATSHIRT WITH ZIPPER



Verifica modelli e disponibilità sul sito web!
Check out our models and their availability on the website!





.01 .23 .08



38085
Villamar

Smartwatch multifunzione, con connessione bluetooth 4.0, ricaricabile con connettore micro USB, integrato nel cinturino. Cinturino in TPU e schermo integrato da 0,96 | Multifunction smart bracelet, with Bluetooth® 4.0 connectivity and rechargeable via micro USB connector. TPU body and built-in 0,96 inches. With heart rate monitoring and several functions.

TPU | TPUs

24 x 2,1 x 1,4 cm



.02



.01



38000
Alaister

Smartwatch multifunzione bluetooth. Ricaricabile tramite connettore microusb. Display TFT da 1,3. Controllo del battito cardiaco e molte altre funzioni. | Multifunction smart watch with Bluetooth® 4,0 connectivity. Rechargeable via micro USB connector. TPU body and built-in 1,3 inches, colour TFT display. With heart rate monitoring and several functions.

Cinturino In Tpu | Tpu strap

27,5 x 3,6 x 1,3 cm



.01



38047
Grazia

Smartwatch multifunzione, connessione Bluetooth® e ricaricabile tramite cavo USB -incluso. Cinturino in TPU e touch screen IPS. Funzione "BT calling. Cardiofrequenzimetro, la pressione sanguigna e l'ossigeno nel sangue e altre funzioni. | Multifunctional smart watch, Bluetooth® connection and rechargeable via USB cable -included-. With TPU strap and integrate IPS touch screen. With "BT calling" function. Other functions such as heart rate monitor, blood pressure and other function.

Cinturino In Tpu | Tpu strap

27 x 4 x 1,3 cm



MULTIFUNCTIONAL SMARTWATCHES

Multifunctional smartwatches with bluetooth connection and USB recharging cable included





88047
Mare

Pettorina sportiva da adulto, con fasce elastiche laterali. | Sporty adult bib in resistant non-woven with elasticated sides.

TNT No-woven | TNT No-woven

53 x 63 cm



88017
Maina

Pettorina sportiva da adulto, con fasce elastiche laterali. | Sporty bib for adult in polyester with elastic side.

Poliestere 190T | 190T polyester

52 x 63 cm



14056
Sospirolo

Coperta termica per attività sportive. Resistente all'acqua e al vento. | Thermal blanket for sports activities. Water and wind resistant.

Alluminio | Aluminum

210 cm



65071
Michi

Luce per lo sport con fascia elastica per il braccio o la testa, luci bianche 8 COB con 3 modalità di accensione (2 fisse e una lampeggiante). | Sporty line torch with adjustable elastic band for arm, head... 8 COB white lights with 3 lighting modes (2 direct modes + 1 flashing light).

6,1 x 1,7 x 4 cm



41150
Fredrick

Polsino con tasca con zip coordinata. | Wristband with zipper pocket in matching colour and firm fit.

Microfibra | Microfiber

10 x 9 cm



86009
Juuka

Kit di riparazione di emergenza per bicicletta. Comprende chiavi a brugola, chiave inglese e chiave per raggi. Chiave per dadi. Cacciavite a stella e piatto, 2 leve per pneumatici. 7 patch (3 circolari, 3 rettangolari e 1 rettangolare extra-large). 1 tube | Emergency repair set for your bike. Includes: Allen wrenches, Wrench and 14GE SPEAKED. 8, 9 and 10 TAKES. Star and flat screwdriver. 2 levers for tires. 7 patches (3 circular, 3 rectangular and 1 extra-large rectangular). 1 can of glue.

Poliestere 600D | 600D polyester

9,5 x 12 x 3,6 cm



WAISTBAG

With main zipped compartment.



.01



65088
Vescovana



Marsupio con scomparto principale con chiusura con cerniera. | Waist bag with main compartment with zip closure.

RPET 210D | RPET 210D

38 x 12 cm



65520
Aspio

Marsupio con due scomparti con zip colorata coordinata. Vita regolabile con fibbia. | Waist bag with two matching colour zipper pockets and adjustable buckle closure waist.

Poliestere 600D | 600D polyester

25 x 17 x 8 cm



.18 .01 .17 .07



60163
Marathon

Cintura multiuso, in tessuto elastico. Cerniera riflettente. Passante per auricolari. Taglia unica. | Multi-purpose belt, in elastic fabric. Reflective zipper. Loop for earphones. One size.

Poliestere | Polyester

23 x 5,5 cm

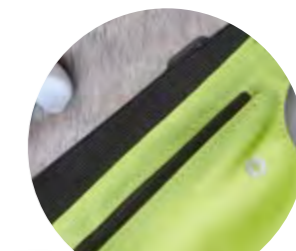

60151
Mel

Marsupio da running con chiusura zip, dettagli riflettenti, passante per auricolari, chiusura con fibbia regolabile, elastica. | Running waist bag with zipper closure, reflective details, headphone outlet and elastic adjustable buckle closure waist.

Poliestere | Polyester

22 x 22 x 7 cm



SPECIAL SIZE



65082
Sodio

Zaino classico in tessuto resistente. Ampio scomparto principale con tasca frontale con cerniera. Cerniere, tirazip e maniglia a contrasto, spallacci imbottiti regolabili. | Classic backpack in durable fabric. Spacious main compartment with zippered front pocket. Contrasting zippers, pulls, handles and adjustable padded straps.

Tessuto resistente | Durable fabric
30 x 40 x 18 cm, 20 L.



MELANGE FINISH



64291
Rutenio

Zaino classico con finitura melange. Tasca frontale con passante per cavi. Schienale e spallacci imbottiti. Dettagli in nero. Etichetta removibile. | Classic backpack in blend of colors. Main compartment with front pocket with zipper and cable outlet. Zippers, zipper pullers, contrasting handles. Adjustable padded straps.

Poliestere 300D | 300D polyester
30 x 40 x 12 cm, 14 L.



64170
Horel

Zaino chiusura con zip, tasca frontale con zip. Angoli rinforzati, tirazip con inserti in tessuto Schienale imbottito e spallacci regolabili imbottiti. | Backpack in polyester, with zipper closure and front pocket. With reinforced corners, handles with strap. Padded back and adjustable shoulder straps with padding.

Poliestere 600D | 600D polyester
27 x 37 x 12 cm



64199
Skogaby

Zaino con due scomparti principali con chiusura zip. Una tasca frontale con zip e una aperta. Tasca laterale in rete. Spallacci regolabili. | Backpack with 2 main compartments with zipper closure. One front pocket with zip and one open. Side mesh pocket. Adjustable straps.

Poliestere 600D | 600D polyester
45 x 30 x 16 cm



64236
Chica

Zaino dotato di due scomparti principali con chiusura a cerniera e tasca frontale. Tasche laterali a rete ed accessori neri. Schienale imbottito e spallacci regolabili con imbottitura. | Backpack with two main compartments with zipper closure and front pocket. Padded back and adjustable shoulder straps with padding.

Poliestere 600D | 600D polyester
31 x 41 x 16 cm



.08

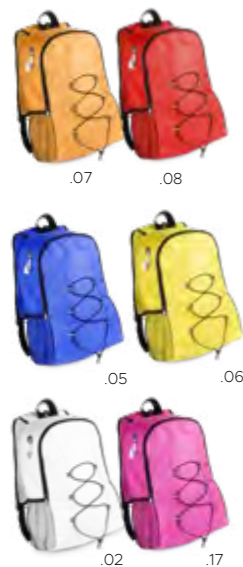

Zaino con chiusura zip, passante per auricolari, inserto elastico nella parte frontale, tasche laterali elastiche in rete. Schienale e spallacci imbottiti. | Backpack with zipper closure, exit for headphones, elastic string set in front and elastic net pockets on the sides. With padded back and adjustable shoulder straps with padding.

Poliestere 600D | 600D polyester
43 x 15 x 29 cm



Zaino con chiusura zip, inserto elastico sul fronte, tasche laterali elastiche in rete. Con spallacci regolabili. | Backpack with zipper closure, elastic string set in front, elastic net pockets on the sides. With adjustable shoulder straps.

Poliestere 600D | 600D polyester
42 x 25 x 16 cm



Zaino multifunzione. Spallacci imbottiti. Apertura centrale estendibile. Tasca frontale con cerniera e soffietto. Tasche laterali. Tasca interna regolabile. | Multifunction backpack. Double padded handle for shoulder. Extendable central opening. Front pocket with zipper and bellows. Side pockets. Adjustable interior pocket.

Poliestere | Polyester
44 x 30 x 13 cm



Zaino con chiusura con doppia fibbia. Passante per auricolari, tasche laterali elastiche in rete, spallacci regolabili. | Backpack with double buckle closure. Exit for headphones, elastic net pockets on the sides, adjustable straps.

Poliestere | Polyester
42 x 29 x 11,5cm



Zaino sportivo. Tasca principale e frontale con chiusura a cerniera. Scomparto frontale con cordini elastici con tasche laterali in rete. Schienale e spallacci imbottiti. | Sports backpack. Main and front pocket with zip closure. Front compartment with elastic cords with mesh pockets. Padded back and shoulder straps.

Poliestere 600D | 600D polyester
30 x 45 x 14 cm

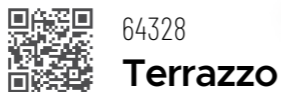

Zaino sportivo ad alta resistenza. Doppio scomparto principale con chiusura a cerniera e tasche interne. Scomparto anteriore con cordino elastico e tasche laterali a rete. Schienale e spallacci imbottiti. Fibbie laterali regolabili. | High resistance sports backpack. Double main compartment with zip closure and internal pockets. Front compartment with bungee cord and side mesh pockets. Padded back and shoulder straps. Adjustable side buckles.

Nylon ripstop 210D | 210D ripstop nylon
32 x 47 x 20 cm



Zaino con chiusura zip. Tasca frontale con zip, manici rinforzati e spallacci regolabili. | Backpack with double buckle closure. Exit for headphones, elastic net pockets on the sides, adjustable straps.

Poliestere | Polyester
39 x 28 x 17,5 cm



Zainetto multifunzione in tessuto resistente ed impermeabile, spallacci regolabili e maniglia speciale in tinta, tasca principale di grande capacità e tasca frontale con cerniera in tinta, tasche interne con spugna estraibile per proteggere la schiena. | Multifunction backpack in resistant and waterproof fabric, adjustable shoulder straps and special handle in the same color, large capacity main pocket and front pocket with matching zip, internal pockets with removable sponge to protect the back.

Poliestere, Cotone | Polyester, Cotton
28 x 36 x 11 cm



BACKPACKS WITH CASUAL DESIGN

With adjustable shoulder straps with padding.



 64194
Skubb

Zaino con chiusura zip. Tasca frontale con zip, manico rinforzato e spallacci regolabili. | Backpack with zipper closure, exit for headphones, elastic string in front with reflective support and elastic mesh side pocket. With padded back and adjustable shoulder strap.

Poliestere | Polyester
38 x 21 x 10 cm



.23



 64183
Giaglione

Zaino con chiusura zip e tasca frontale. Dettagli grigi, con schienale e spallacci imbottiti. | Backpack with zipper closure and front pocket. Accessories in grey, with padded back and shoulder straps.

Poliestere 600D | 600D polyester
23 x 40 x 12 cm

145 gr/m² 7l



.07 .05 .01 .02 .04



.17 .70 .23 .08

 64100
Tangerino

Zaino, con chiusura zip, passante per auricolari, tasca frontale, tasche elastiche in rete laterali. Spallacci regolabili imbottiti. | Backpack with zipper closure, headphones outlet, front pocket and elastic webbing pockets on the sides. With adjustable shoulder straps with padding.

Poliestere 600D | 600D polyester
30 x 40 x 16 cm

340 gr/m² 12l



.08



.06



.19 .23 .01 .08



55791
Skådis

Sacca zaino con chiusura con coulisse, tasca frontale con zip, spallacci regolabili. | Backpack with drawstring closure, front pocket with zipper closure, adjustable straps.

Poliestere | Polyester

42,5 x 40 x 10 cm



.08 .01 .23 .05



64295
Seborgio

Zaino sportivo con ampio scomparto principale con chiusura zip. Piccola tasca frontale con zip. Scomparto inferiore porta scarpe con zip. Cerniere a contrasto. Spallacci regolabili. | Sporty backpack with large main compartment and zipper closure.

Poliestere 900D | 900D polyester

34 x 65 x 33 cm



.19



.05



.08



64147
Loksa

Zaino con manici regolabili | Backpack with adjustable straps and zip

Poliestere 600D | 600D polyester

40 x 28,5 x 17,5 cm



.01 .19 .18



64541
Onice

Zaino con due scomparti principali con zip. Interno imbottito per portatile. Chiusura con fibbia ai lati. Tasca frontale con zip. Tasche laterali elastiche in rete. Manico imbottito. Spallacci regolabili. | Backpack with 2 main zippered compartment. Inside padded compartment for laptop. Buckle closure at sides. Zippered front pocket. Sides lateral elastic mesh pockets. Padded handle. Adjustable straps.

Poliestere | Polyester

30 x 17 x 47 cm



NEW



.05 .08 .01 .23



64294
Santoreggia

Zaino sportivo con due scomparti con chiusura zip. Scomparto inferiore porta scarpe con zip. Cerniere colorate coordinate. Spallacci regolabili. | Sports backpack with two compartments with zip closure. Bottom compartment for shoes with zip. Coordinated colored hinges. Adjustable shoulder straps.

Poliestere 900D | 900D polyester

32 x 46 x 20 cm





.01



65086

Lamon



Borsone da viaggio, molto capiente e resistente. Ampio scomparto principale. Manici lunghi per un facile trasporto. Tracolla regolabile. | Travel bag, very large and resistant. Large main compartment. Long handles for easy carrying. Adjustable shoulder strap.

Poliestere RPET 300D | 300D RPET polyester

48 x 25,5 x 19,5 cm



.13



65091

Leguzzano



Borsone con ampio scomparto principale con chiusura con zip, con manici e tracolla regolabile. | Duffel bag with large main compartment with zip closure, with handles and adjustable shoulder strap.

Cotone riciclato - 280 gr/m² | Recycled cotton - 280 gr/m²

56 x 27 x 45 cm



.13



65092

Masi



Borsa con ampio scomparto principale con chiusura con zip, con manici. | Bag with large main compartment with zip closure, with handles.

Cotone riciclato - 280 gr/m² | Recycled cotton - 280 gr/m²

42 x 25 x 28 cm



.03

.23

.01



65089

Zevio



Borsone sportivo con finitura mélangé. Ampio scomparto principale con chiusura con zip. Tasca frontale con chiusura con zip. Tasca laterale a rete. Manici con chiusura in velcro. Tracolla regolabile inclusa. | Sports bag with a mélangé finish. Large main compartment with zip closure. Front pocket with zip closure. Side mesh pocket. Handles with velcro closure. Adjustable shoulder strap included.

RPET 300D | RPET 300D

50 x 28 x 24 cm



.05



65093

Mozzecane



Borsa weekend con ampio scomparto principale con chiusura con zip, con manici e tracolla regolabile. | Weekend bag with large main compartment with zip closure, with handles and adjustable shoulder strap.

Cotone riciclato - 280 gr/m² | Recycled cotton - 280 gr/m²

56 x 27 x 45 cm



.05



65094

Pederobba



Borsa con ampio scomparto principale con zip, con manici. | Bag with large main compartment with zip, with handles.

Cotone riciclato - 280 gr/m² | Recycled cotton - 280 gr/m²

42 x 25 x 28 cm



BAG IN RECYCLED COTTON

Multipurpose bag with mélange finish. Equipped with a comfortable adjustable shoulder strap.



65087
Casalserugo



Borsone multiuso con finitura mélange. Capacità 24L. Ampio scomparto principale con chiusura zip. Dotato di confortevole tracolla regolabile | Multipurpose bag with mélange finish. 24L capacity. Large main compartment with zip closure. Equipped with a comfortable adjustable shoulder strap

Cotone riciclato - 320 gr/m2 | Recycled cotton - 320 gr/m2

49 x 24 x 26 cm



65090
Foza



Borsone sportivo, ampio scomparto principale con chiusura zip, manici rinforzati, tracolla regolabile. | Sports bag, with large main compartment with zip closure, reinforced handles, adjustable shoulder strap.

Cotone riciclato - 300gr/m2 | Recycled cotton - 300gr/m2

49 x 24 x 26 cm



64299
Ponso



Borsone sportivo color natural, ampio scomparto principale, manici rinforzati, tracolla regolabile. | Sports bag in natural color, large main compartment, reinforced handles, adjustable shoulder strap.

Cotone riciclato - 300gr/m2 | Recycled cotton - 300gr/m2

49 x 24 x 26 cm



64322
Casier



Zaino con finitura mélange, ampio scomparto principale, tasca frontale con zip, spallacci regolabili | Backpack with mélange finish, large main compartment, front zip pocket, adjustable shoulder straps

Cotone riciclato - 320 gr/m2 | Recycled cotton - 320 gr/m2

43 x 34 x 9 cm





.55



.03

.23



.83

.08



.08



65068
Chicco

Borsa multiuso, base e dettagli in grigio. Scomparto principale e tasche laterali con chiusura a cerniera. Manici in nylon resistente, con chiusura in velcro abbinata. Include tracolla regolabile con chiusura a moschettone e tracolla abbinata. | Multipurpose bag of high capacity. Two-colour design, with grey base and details. Main compartment and side pockets with zip closure. Includes adjustable shoulder strap with carabiner closure and matching shoulder pad.

Poliestere 600D | 600D polyester

☐ 65 x 34 x 33 cm



65125
Rotolo

Borsa sportiva. Ampio scomparto principale, manici rinforzati. Tracolla regolabile. | Heathered sports bag with large inside compartment, and reinforced handles. Adjustable shoulder strap.

Poliestere 600D | 600D polyester

☐ 24 x 52 cm



.23

.05

.08



.07

.17

.04



65022
Reina

Borsone molto resistente, design bicolore, con piping di rinforzo. Scomparto principale e tasca esterna con zip colorata coordinata. Con manici in nylon con chiusura in velcro. Tracolla regolabile, con doppio moschettone. | Bag with reinforcement piping and base in white colour. Main compartment and outside pocket with zipper closure. With resistant nylon handles velcro closure and adjustable shoulder strap.

Poliestere 600D | 600D polyester

☐ 45 x 21 x 25 cm



.01



.23

.05

.08

.01



65077
Silicio

Borsone sportivo con ampio scomparto principale con zip. Scomparto inferiore porta scarpe. Maniglie superiori rinforzate. Tracolla regolabile. Piccola tasca laterale con zip. Cerniere colorate coordinate. | Sports bag with large main compartment with zip. Lower compartment for shoes. Reinforced upper handles. Adjustable shoulder strap. Small side pocket with zip. Coordinated colored hinges.

Poliestere 600D | 600D polyester

☐ 42 x 48 x 26 cm



SPORT BAGS

Sports bag with double handle and a long adjustable carry strap. Shoe pocket with removable compartment.



.17



.01



.03



65080
Nona

Borsa dal design bicolore con doppio manico regolabile. Chiusura principale con cerniera e tasca laterale con cerniera invertita. Tasca frontale con velcro. Base rinforzata. | Two-tone design bag with double adjustable handle. Main zip closure and side pocket with inverted zip. Front pocket with velcro. Reinforced base.

Poliestere | Polyester

42 x Ø 27 cm 20 L

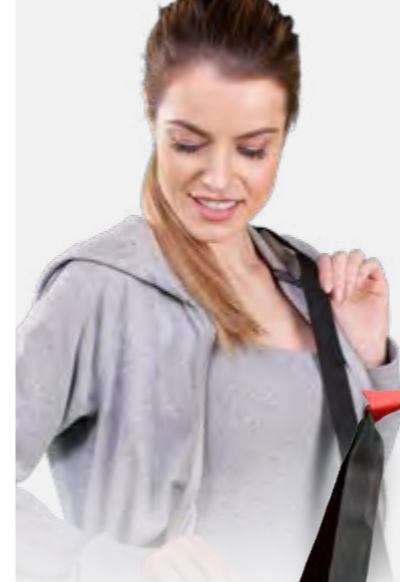

.05



.18



.23



.01



.07



.08



65124
Gissi

Borsone sportivo con ampio scomparto principale con chiusura zip a U. Tasca frontale con zip. Tasca laterale con inserto in rete. Altra tasca laterale aperta. Manici rinforzati e tracolla regolabile. | Sports bag with large main compartment with U-shape zipper closure. Front pocket with zip. Side pocket with mesh detail. Another one side pocket. Reinforced handles and adjustable shoulder strap.

Poliestere 600D | 600D polyester

62 x 28 x 27 cm



.01



.19



.08



.23



.17



65515
Springa

Borsa da viaggio con ampio scomparto principale con chiusura zip e tasca frontale con chiusura in velcro. Manici rinforzati e tracolla regolabile. | Travel bag with large main compartment with zipper closure and front pocket with velcro closure. Reinforced handles and adjustable shoulder strap.

Poliestere | Polyester

45 x 23,5 x 16 cm



.05



65127
Giffenga

Borsone bicolore effetto jeans con inserti in similpelle, ampio scomparto principale con chiusura con zip. Maniglie rinforzate con inserto in similpelle, base in similpelle, etichetta frontale in similpelle, particolarmente adatta per la stampa. | Duffel bag, bicolor design denim look, with faux leather inserts, large main compartment with zip closure. Reinforced handles with leatherette insert, leatherette base, leatherette front label, particularly suitable for printing.

Cotone | Cotton

55 x 39 x 23 cm



.03



65069
Sanning

Borsone weekend con ampio scomparto principale con chiusura zip. Tasca frontale con zip. Manici rinforzati e tracolla regolabile. | Week-end bag with large main compartment with zipper closure. Front pocket with zip. Reinforced handles and adjustable shoulder strap.

Poliestere | Polyester

55 x 28 x 20 cm



.05



64336

Portogruaro



Sacca zaino con chiusura a coulisse. | Backpack bag with drawstring closure.

Cotone, Denim riciclato - 250 gr/m2 | Cotton, Recycled Denim - 250 gr/m2

38 x 42 cm

250 gr/m²



.23 .08 .13 .19



.13



17228

Frido



Sacca zaino con coulisse. | Drawstring bag.

100% Cotone Organico - 120 gr/m2 | 100% Organic Cotton - 120 gr/m2

38 x 42 cm

120 gr/m²



.01



64261

Coriglianeto



Sacca zaino. Con coulisse. | Drawstring bag

100% Cotone Riciclato | 100% Recycled Cotton

38 x 42 cm

120 gr/m²



.01 .23 .02 .08



.05



65129

Portogruaro



Sacca zaino, chiusura con coulisse. Finitura solida. | Backpack drawstring closure. Solid finish.

Cotone riciclato - 140gr/m2 | Recycled cotton - 140gr/m2

38 x 42 cm

140 gr/m²



.13



64335

Pedemonte



Sacca zaino color natural, chiusura con coulisse coordinata. | Natural color backpack, closure with coordinated drawstring.

Cotone riciclato - 140gr/m2 | Recycled cotton - 140gr/m2

38 x 42 cm

140 gr/m²



64096
Rolinka



Sacca zaino. Chiusura con coulisse colorata coordinata | Drawstring backpack. With matching colour self closing strings

100% Cotone | 100% Cotton

38 x 41 cm



.13



65043
Ebast



Sacca zaino con chiusura con coulisse coordinata. | Drawstring backpack. With matching colour self closing strings.

100% Cotone | 100% Cotton

37 x 40 cm



.23

RECYCLED PLASTIC



64229
Oro



Sacca zaino. Chiusura con coulisse. | Drawstring bag

RPET | RPET

32 x 42 cm



RECYCLED PLASTIC



64781
Acquaniti



Sacca zaino con tasca frontale con zip con passante per auricolari. Chiusura con coulisse. | Drawstring backpack with front zippered pocket and earphones output.

RPET | RPET

33 x 41 cm



DRAWSTRING BAGS

Made of recycled plastic.



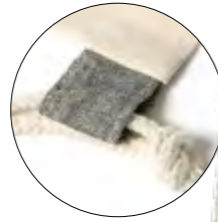

64326
Rubano



Sacca zaino con coulisse, finitura mélange. Cordini in colore naturale. | Backpack bag with drawstring, mélange finish. Lanyards in natural color.

Cotone riciclato, Cotone naturale - 120 g/m2 | Recycled cotton, Natural cotton - 120 gr/m2

38 x 42 cm

120 gr/m²



64333
Massanzago



Sacca zaino con coulisse | Backpack bag with drawstring

Cotone Fairtrade | Fairtrade cotton

38 x 41 cm

180 gr/m²



64331
Fossò



Sacca zaino con coulisse. | Backpack bag with drawstring.

Cotone biologico - 140 g/m2 | Organic cotton - 140 gr/m2

37 x 41 cm

140 gr/m²

100% HEMP FABRIC



100% HEMP FABRIC



64327
Soave



Sacca zaino con coulisse, con cordini abbinati. | Drawstring backpack bag, with matching drawstrings.

Canapa - 200 gr/m2 | Hemp - 200 gr/m2

38 x 42 cm

200 gr/m²



65055
Meithloun



Sacca zaino con coulisse spessa e intrecciata, angoli rinforzati. | Drawstring backpack. With thick, braided strings and reinforced corners.

Juta, Cotone | Jute, Cotton

34 x 43 cm

120 gr/m²





SPORT DRAWSTRING BAGS

With elastic string.



.70

.17



.03



.05



64300 Tosterö

Sacca zaino effetto denim, con chiusura coulisse, e cordoncini spessi in cotone. | Drawstring backpack in polyester with a denim look with thick cotton handles.

Poliestere | Polyester

34 x 42 cm

350 gr/m²



64314 Odetta

Sacca zaino effetto denim, chiusura con coulisse in cotone. Design semplice e moderno. | Drawstring backpack with denim look with thick cotton handles. Simple and modern design.

Poliestere | Polyester

34 x 42 cm

350 gr/m²



.02

.01

.06

.23

.08

.17

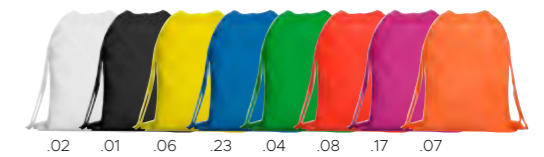

.02

.01

.06

.23

.04

.08

.17

.07



.05



.02

.23

.08

.01



64293 Samario

Sacca zaino sportiva con chiusura con coulisse. Coulisse piatta coordinata, tasca interna. | Sports drawstring bag in plain design. Matching flat drawcords.

Poliestere 600D | 600D polyester

42,5 x 35,5 cm

150 gr/m²



64208 Clématite

Sacca zaino. Tasca frontale con zip e passante per auricolari. Chiusura con coulisse, zip coordinata, angoli rinforzati in PU con occhielli metallici. | Drawstring backpack with zippered front pocket and headphones output. Self closing strings, matching colour zipper, and corners with metal eyelets and PU leather reinforcement.

Poliestere 210D | 210D polyester

34,5 x 45 cm



70 gr/m²



64292 Rutherfordio

Sacca zaino con coulisse da 8mm di spessore | backpack with thick adjustable laces.

Poliestere 210T | 210T polyester

35 x 45 cm

70 gr/m²

DRAWSTRING BAGS

With high-visibility front band.



64188
Gavorrano

Sacca zaino con tasca frontale in rete con zip. | Drawstring bag with front mesh pocket with zip.

Poliestere 210D | 210D polyester

33 x 41,7 cm



64053
Mirtel

Sacca zaino con tasca frontale con zip e passante per auricolari. Tasca in rete, con occhielli metallici di rinforzo sugli angoli, chiusura con coulisse. | Drawstring backpack, with zippered front pocket and headphones output. Includes mesh pockets, with metal eyelet reinforced corners and black self-closing cords.

Poliestere 210D | 210D polyester

34 x 43 cm



64332
Legnago

NEW

Sacca zaino con coulisse e inserto ad alta visibilità | Backpack bag with drawstring and high visibility insert

Poliestere 210D | 210D polyester

36 x 41 cm



64102
Camden

Zaino sacca, con angoli rinforzati. Disponibile in 3 varianti: calcio, basket e tennis. | Drawstring backpack with reinforced corners and available in 3 designs: football, basketball and tennis.

Poliestere 210D | 210D polyester

43 x 43 cm





BACKPACKS DESIGNED FOR SUBLIMATION

With drawstring fastening.



.08 .07 .06 .04 .24 .17 .16 .05 .23 .02 .01



64310
Socrate

Sacca zaino con chiusura con coulisse | Backpack with drawstring fastening

Poliestere 210D | 210D polyester

34 x 42 cm

70 gr/m



.08 .07 .06 .11 .19



.23 .24 .01 .05 .02



64088
Gott

Sacca zaino. Con chiusura con coulisse nera e occhielli metallici di rinforzo sugli angoli. | Drawstring backpack with black self closing strings and reinforced corners with metal eyelets.

TNT No-woven | TNT No-woven

37 x 40,5 cm

80 gr/m



.18



.13



64221
Vaasa



Sacca con coulisse, ideale per sublimazione | Drawstring bag especially designed for sublimation.

Poliestere | Polyester

34 x 40 cm

450 gr/m



.01 .02 .24 .05 .23 .18



.03 .08 .07 .04 .29 .06

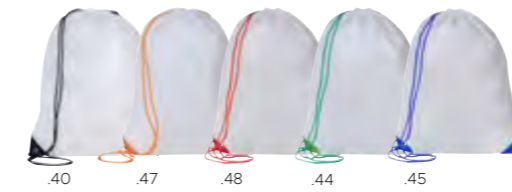

.40 .47 .48 .44 .45

FLUO!



.90 .17 .16



.33



64093
Nella

Sacca zaino. Chiusura con coulisse, angoli in PU colorati coordinati con occhielli metallici di rinforzo. | Drawstring backpack with self closing strings and corners with metal eyelets and PU leather reinforcement in matching colour.

Poliestere 210T | 210T polyester

34 x 42 cm



Tools and Torches

Tools and Torches

Set utensili, coltelli multifunzione, guanti, torce, metri, portachiavi, raschia ghiaccio, giacche ad alta visibilità e altri accessori di sicurezza.

Tool sets, multi-function knives, gloves, torches, meter measures, keychain, high-visibility jackets and other safety accessories.

TOOLS KITS

Tool set of 20 accessories in resistant case with wheel design.



20 ACCESSORIES



82708
Askholmen

Set attrezzi 20 pz in custodia a forma di ruota. Fornito in confezione singola | Tool set of 20 accessories in resistant case with wheel design. Presented in an individual box.

Abs | Abs

11 x 12,9 x 4,9 cm



.01



6 ACCESSORIES



81027
Silene

Attrezzo multifunzione con 6 accessori. Include sei punte per cacciavite, piatte e a stella. | Multitool with 6 accessories. With non-slip body and metal clip. Includes 6 flat and cross-head screwdriver heads.

Alluminio | Aluminum

11 x 1,3 cm



4 ACCESSORIES

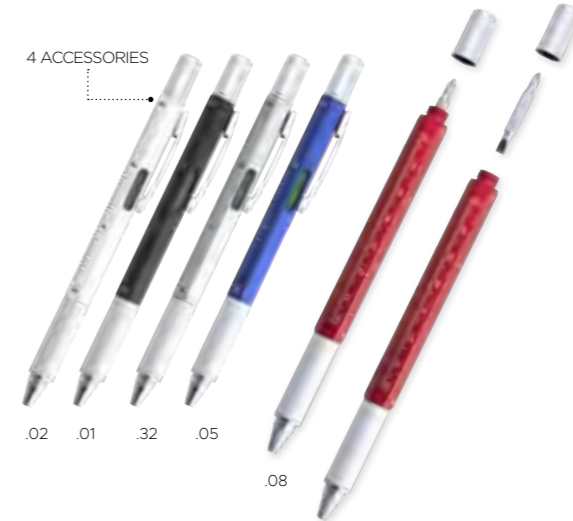

22131
Picos

Penna a sfera multi funzione 4 in 1, meccanismo a torsione, impugnatura morbida. Livella incorporata, righello con sistema metrico in centimetri e pollici, e doppio cacciavite. | Multi-tool ball pen 4-in-1 with twist mechanism, with soft grip. With built-in level in body, ruler with metric system in centimetres/inches and double-head screwdriver -flat and star-shaped.

Plastica | Plastic

14,9 x 1 cm



8 ACCESSORIES



81007
Miane

Utensile multiuso a forma di penna. 8 teste di cacciavite, a stella e piatte, incluse. | Pen-shaped multipurpose tool. 8 screwdriver heads, star and flat, included.

Alluminio | Aluminum

11 x 1,3 cm



NEW



.23

.08

.04

.01



.32



82058
Berchidda

Attrezzo multifunzione, con 11 funzioni. Fornito in custodia | Multi-tool with resistant stainless steel body with 11 functions. Presented in resistant leather case.

Acciaio Inossidabile | Stainless steel

8 x 5,5 x 0,30 cm



.05

.06

.02

.04

.08



86133
Galant

Taglierino con lama larga e manico ergonomico. Cappuccio rimovibile per regolazione della lama. | Cutter with wide blade and ergonomic handle. Removable hood for blade cutting adjustment.

Plastica | Plastic

15,5 x 1,4 cm



.05

.01

.08



.02



47135
Apatite

Portachiavi con metro pieghevole da 50cm. Con retro liscio per la stampa. | Original 50 cm folding ruler keychain. With smooth back side for printing.

Plastica | Plastic

3 x 6,5 x 1,5 cm



.02

.08



81039
Vien

Doppio metro pieghevole. 2 mt | Foldable meter. 2mt.

Fibrosina, Plastica | Fiberglass, Plastic

23 cm



.02

.05

.08

.04



25401
Benitez

Matita in legno da carpentiere, con corpo piatto. Mina nera. | Wooden carpenter pencil type with flattened body with black coloured lead.

Legno | Wood

18 x 1 cm



.21



47008
Cant

Portachiavi trasparente con livella | Spirit level with keychain

Plastica | Plastic

4 x 1,5 x 1,5 cm



1MT

.02



47097
Tungar

Flessometro 1 mt. | Measuring tape 1 mt.

Plastica | Plastic

5,5 x 4 x 1 cm



1MT

.02



46940
Bereguardo

Portachiavi con metro (1mt). | Keyring with measuring tape, 1 meter

Plastica | Plastic

4,5 x 5,2 cm



1MT
┌───┐



47018
Alanez

Portachiavi con metro e livella | Level measuring tape with keyring

Plastica | Plastic

┌───┐ 4,3 x 4,2 x 0,9 cm



1MT
┌───┐



83100
Askvoll

Portachiavi con flessometro da 1m, con blocco di sicurezza. Misurazione in centimetri, pollici e piedi. | 1 metre keychain flexometer with metal blade and locking mechanism. Measuring system in centimetres, inches and feet.

Abs | Abs

┌───┐ 4,3 x 4,1 x 1,5 cm



5MT
┌───┐



81000
Peperoncino

Metro da 5m con finitura gommata in colore nero. Dotato di clip per appenderlo alla cintura. | 5m tape measure with black finish

Abs | Abs

┌───┐ 9 x 7 x 3 cm



2MT
┌───┐



81042
Fantig 2

Flessometro con bottone di arresto e clip per cintura. 2 mt. | Measuring tape with stop button and belt clip. 2mt.

Plastica, Metallo | Plastic, Metal

┌───┐ 6,5 x 5,5 x 2,5 cm



3MT
┌───┐



3MT
┌───┐



81008
Mussolente

Flessometro da 3 m con meccanismo di bloccaggio e nastro metallico. Clip in metallo, laccetto, inserto frontale in bambù. | 3m measuring tape with locking mechanism and metal tape. Metal clip, lanyard, bamboo front insert.

Plastica, Bamboo | Plastic, Bamboo

┌───┐ 6,5 x 6,5 cm



81789
Knoppäng

Flessometro da 3 metri con rivestimento in gomma, clip in metallo per la cintura e laccettino. | 5 metre flexometer with metal blade and locking mechanism, coated rubber, metallic clip for belt and carrying belt.

Plastica | Plastic

┌───┐ 6 x 6 x 3 cm

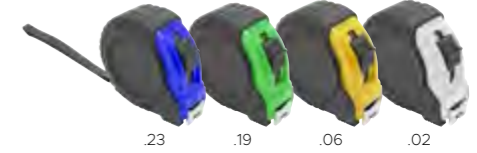

5MT
┌───┐



81001
Pskov

Flessometro da 5 metri con meccanismo di bloccaggio e nastro in metallo. Corpo gommato, clip in metallo e maniglia. | 5 m flexometer with blocking mechanism and metallic strip hook. Body in colour rubber, metallic clip and carry strap.

Plastica | Plastic

┌───┐ 7 x 7 x 3,5 cm



MULTIPURPOSE JACKKNIFE

In stainless steel with 6 functions.



82070
Bacopa

Coltello multiuso in acciaio inossidabile. con 6 funzioni: coltello, apriscatole, apribottiglie, cavatappi, cacciavite e portachiavi. | Stainless steel multipurpose jackknife with 6 functions: knife, bottle opener, can opener, corkscrew, screwdriver and keyring.

Acciaio Inossidabile | Stainless steel

7,6 x 0,7 x 21 cm



71048
Changsha

Utensile multifunzione. Pieghevole, comprende pinza, cacciaviti, coltellini e molte altre funzioni. Fornito con pouch. | Multifunction tool. Foldable, includes pliers, screwdrivers, pocket knives and many other functions. Supplied in a pouch.

Acciaio Inossidabile, Plastica | Stainless Steel, Plastic

10 x 3 cm



.01



82076
Pernumia

Utensile multiuso. Design compatto. 11 funzioni, tra cui cacciavite e attrezzo per catene. | Multipurpose tool. Compact design. 11 functions, including screwdriver and chain tool.

Acciaio Inossidabile | Stainless steel

9,1 x 1,8 cm



11 FUNCTIONS



71038
Buio

Coltello multiuso realizzato in bambù e acciaio inossidabile, con 9 funzioni. Include coltello, apriscatole, forbici, lima, cacciavite, cavatappi. | Multipurpose knife, in combination of bamboo and stainless steel materials, with 9 functions. With strap for transport in PU leather.

Acciaio Inossidabile, Bambù | Stainless Steel, Bamboo

9,4 x 2,5 x 1,4 cm



12 FUNCTIONS



71047
Buona

Multiattrezzo 12 funzioni con corpo in acciaio inox e impugnatura in bambù. Include coltelli e lame; cacciaviti, lime, apriscatole e pinze | Multi-tool with resistant stainless steel body and bamboo handle, 12 functions. Includes knives and blades; screwdrivers, files; openers and pliers. With PU leather carrying strap.

Acciaio Inossidabile, Bambù | Stainless Steel, Bamboo

5 x 10,5 x 1,7 cm





.00



.11



.13

A



71039
Genzone



Coltellino in confezione | Creek knife in gift box
Legno, Acciaio | Wood, Steel
9 x 2,6 x 1,2 cm



B



86036
Sedico



Coltello a serramanico. Blocco di sicurezza. | Switchblade knife. Security lock.
Acciaio Inossidabile, legno | Stainless steel, wood
9,1 x 2,4 cm



C



86035
Enego



Coltellino tascabile realizzato in acciaio e bambù. Dotato di laccetto in similpelle | Pocket knife made of steel and bamboo. Fitted with imitation leather strap
Acciaio Inossidabile, Bamboo | Stainless Steel, Bamboo
9,7 x 2,3 x 1,1 cm

POCKET KNIVES

Made of steel and bamboo





.13



.11



86032
Oliva



Coltellino tascabile con manico in legno e lama in acciaio inox | Stainless steel compact pocket-knife of a single use with a natural wooden handle.

Acciaio Inossidabile, legno | Stainless steel, wood

Open: 13 x 2 cm / Close: 7,5 x 2 cm



86033
Onorio



Coltellino tascabile con manico in legno e lama in acciaio inox | Pocket knife with wooden handle

Acciaio Inossidabile, legno | Stainless steel, wood

Open 16 cm / Close 9,5 x 1,5 x 3 cm



85060
Zibo

Lantern da campeggio. Dotata di led potenti, manico a gancio per poterla appendere. Dotata di pulsante di accensione e spegnimento. | Camping lantern. Equipped with powerful LEDs, hook handle for hanging. Equipped with on and off button.

Abs | Abs

18 cm



.02



85048
Cerfoglio

Lampadina LED con sistema intelligente ON/OFF che si attiva tirando il portalam-pada. | Ceiling lamp with LED technology and ingenious on/off system by pulling the lamp holder.

Plastica | Plastic

Ø 5,5 x 15,4 cm



.19

.08

.05

.02



.03



85810
Krugerbo

Lantern da campeggio in plastica, estraibile, maniglie in metallo, 6 LED | Camping lantern made of plastic, pull-out, metal handles, 6 LEDs

Plastica, Metallo | Plastic, Metal

Ø 8,7x12,3 cm, (closed) Ø 8,7x18 cm, (open)





65071
Michi

Luce per lo sport con fascia elastica per il braccio o la testa, luci bianche 8 COB con 3 modalità di accensione (2 fisse e una lampeggiante). | Sporty line torch with adjustable elastic band for arm, head... 8 COB white lights with 3 lighting modes (2 direct modes + 1 flashing light).

6,1 x 1,7 x 4 cm



85007
Maxwell

Torcia tascabile con laccettino da polso. Batterie incluse. Fornita in custodia singola. | Pocket torch with carrying belt, batteries included, presented in an individual case.

Metallo | Metal

17,5 x 6,4 x 3,5 cm



83002
Brandon

Torcia con 2 LED, con carica manuale, corpo semitrasparente. Laccetto da polso. Confezione individuale. | 2 LED flashlight of manual charging with body in translucent finish. With carrying belt and individual box.

Plastica | Plastic

10 x 5 x 2,5 cm

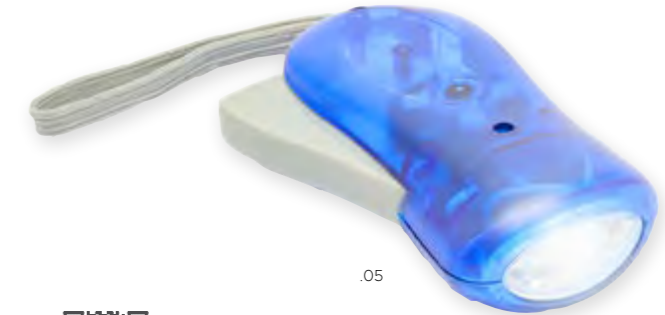
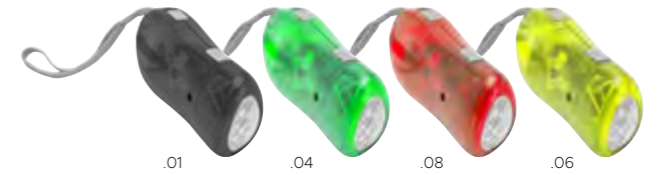

83016
Chandler

Torcia con 3 LED, con carica manuale, corpo semitrasparente. Laccetto da polso. Confezione individuale. | 3 LED flashlight of manual charging with body in translucent finish. With carrying belt and individual box.

Plastica | Plastic

10 x 5 x 2,5 cm



83000
Ghilarza

Torcia 9 led con laccettino da polso. 3 pile AAA escluse | Flashlight with 9 LED light with carrying belt. Batteries not included (3 AAA).

Alluminio | Aluminum

Ø 2,6 x 9 cm



85053
Diletto

Penna a sfera con torcia a luce LED, finitura metallizzata e pulsante nero. Moschettone integrato nel cappuccio. | Ball pen with LED flashlight, metal finish colours and push button in black. In-built carabiner in cap.

Plastica | Plastic

11 x Ø1



85014
Sailil

Torcia Led con moschettone | LED flashlight with carabiner

Alluminio | Aluminum

6 x Ø 1,5 cm





.08 .23 .02



.23 .19 .08 .21



.21



.06



47113
Campanula

Profumatore per auto all'aroma di limone | Lemon scent air freshener for automobile grid.

Plastica | Plastic

4,2 x Ø 5,2 cm



47159
Paese

Profumatore per ambienti, con diverse profumazioni in un contenitore di vetro con tappo in legno e cordoncino regolabile abbinato. Capacità 5 ml. | Air freshener for rooms, with different fragrances in a glass container with wooden cap and matching adjustable cord. Capacity 5ml.

Vetro | Glass

4,8 x 2,3 cm



47160
Ponte

Profumatore per ambienti in vasetto di vetro da 10 ml, con cordino e tappo in legno. Include liquido profumazione oceano. | Air freshener in 10 ml glass jar, with string and wooden cap. Includes ocean fragrance liquid.

Vetro, Legno | Glass, Wood

2,5 x 2,5 x 4,5 cm



.01



.01



85057
Acetosa

Luce di emergenza a LED impermeabile. Approvato e conforme alle normative DGT. Con base magnetica e batteria ricaricabile USB. | Waterproof LED emergency signal light. Approved and compliant with DGT requirements

Plastica, Litio | Plastic, Lithium

8,6 x 6 cm



85055
Columnea

Luce emergenza portatile magnetica a 9 led, omologata, applicabile su diverse superfici. | 9 LED portable and magnetic emergency light homologated for use on various surfaces.

Abs | Abs

5 x Ø 8,3 cm



.02



.02



88076
Gordona

Supporto smartphone da macchina con sistema di fissaggio alla presa d'aria, con rompivetro. | Phone holder for car with air ventilation grille and with glass breaker

Plastica | Plastic

10 x 3 x 5 cm



45000
Gaiola

Portachiavi con misuratore battistrada pneumatici. | Keyring with tires tread check

Plastica | Plastic

10 x 3,2 x 0,5 cm



83057
Ecom

Batteria singola AA/R06 da 1,5V venduta a blister da 4 pezzi. Prezzo per singola batteria | Single 1.5V AA/R06 battery sold in blister packs of 4. Price for single battery

8,5 x 11,5 x 1,6 cm



.00



83055
Emay

Batteria singola AAA/R03 da 1,5V venduta a blister da 4 pezzi. Prezzo per singola batteria | Single 1.5V AAA/R03 battery sold in blister packs of 4. Price for single battery

8,4 x 11,4 x 1,2 cm



.00

YOUR BESPOKE MICROFIBER CLOTH

Clean, dry, dust, scrub, wipe down, polish and more. A versatile cleaning tool that offers high absorbency, and powerful cleaning abilities. Safe for any surface.



MOQ
100 pcs

- 1 Seleziona la misura più adatta alle tue esigenze !**
Select the size based on your needs
- 2 Applica la tua grafica full color...**
Put your CMYK printing



MADE IN ITALY

bespoke
expert in special productions

30 x 20 cm

MADE IN ITALY



CLOTH-20



Panno adatto alla sublimazione. Bordo zigzag | Soft microfiber cleaning cloth designed for sublimation printing. Side cut in zigzag.

Microfibr, Poliestere | Microfibre, Polyester

30 x 20 cm

40 x 30 cm

MADE IN ITALY



CLOTH-21



Panno adatto alla sublimazione. Bordo zigzag | Soft microfiber cleaning cloth designed for sublimation printing. Side cut in zigzag.

Microfibr, Poliestere | Microfibre, Polyester

40 x 30 cm

50 x 40 cm

MADE IN ITALY



CLOTH-22



Panno adatto alla sublimazione. Bordo zigzag | Soft microfiber cleaning cloth designed for sublimation printing. Side cut in zigzag.

Microfibr, Poliestere | Microfibre, Polyester

50 x 40 cm

60 x 40 cm

MADE IN ITALY



CLOTH-23



Panno adatto alla sublimazione. Bordo zigzag | Soft microfiber cleaning cloth designed for sublimation printing. Side cut in zigzag.

Microfibr, Poliestere | Microfibre, Polyester

60 x 40 cm

bespoke
expert in special productions



YOUR BESPOKE CAR AIR FRESHENER

Over 50 different fragrance compositions

1 **Crea il tuo design preferito**
(200 misure standard disponibili)

Create your favourite design
(200 standard sizes)

2 **Scegli la fragranza**
Oltre 50 diverse composizioni di fragranze

Choose your fragrance
Over 50 different fragrance compositions

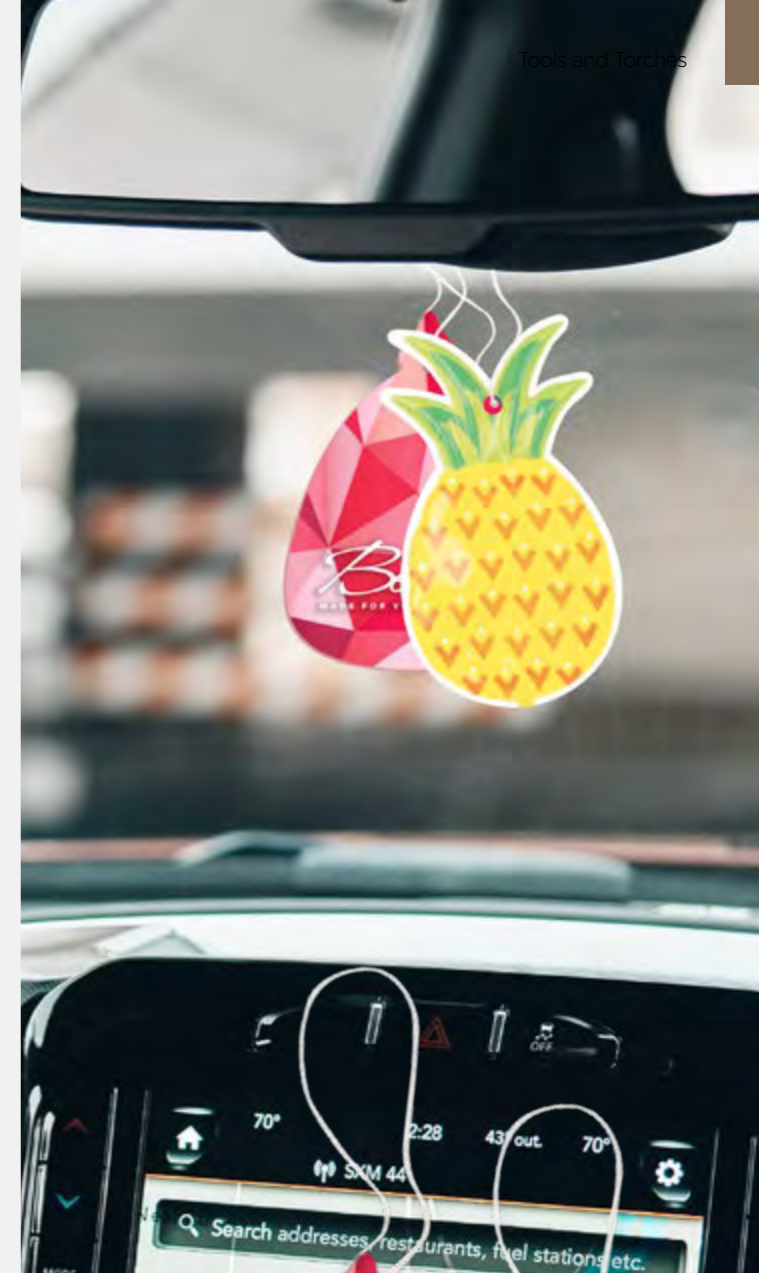

88058
Olimpia

Deodorante per auto con fragranza personalizzata. Stampa a colori su entrambi i lati | Car air freshener with custom fragrance. Full colour printing on both sides.

Carta | Paper



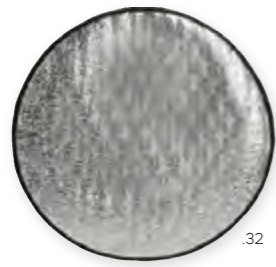

.32



88010
Car

Coprivolante, retro in schiuma. Fornito steso. | One-sided aluminium steering wheel cover. Presentation unfolded for easy printing.

Alluminio | Aluminum

☐ 43 cm

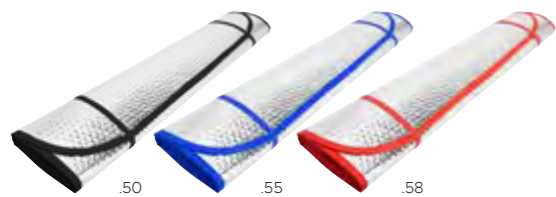

.50

.55

.58



.32



88038
Grisa

Parasole per auto. Due fori in entrambi gli angoli superiori per l'introduzione di ventose per fissare al vetro del veicolo. Bordi ed elastici a colorati. Fornito steso. | Car sun shield. Two eyelets in both upper corners for suction cups. Edging and elastic straps for its folding. Presentation in flat format.

Due lati in alluminio con bolle | Double sided foil with bubble wrap

☐ 130 x 80 cm



88000
Grinch

Parasole per auto. Due fori in entrambi gli angoli superiori per ventose. Bordo nero ed elastici per arrotolare. Fornito steso. | Car sun shield with two eyelets in both upper corners for suction cups. Presentation in flat format.

Alluminio, Plastica - 250 gr/m2 | Aluminium, Plastic - 250 gr/m2

☐ 130 x 80 cm



.32



88061
Amat

Parasole con un lato in alluminio, con finitura silver metallizzata, retro in schiuma. | Sunshade in aluminium on one side in silver metallic finish with polyester edges. Size 130x60cm and foam on the back.

Alluminio | Aluminum

☐ 130 x 60 cm



.32



88059
Cajun

Parasole pieghevole con pratica custodia coordinata inclusa. | Foldable sun block. Includes a handy matching cover.

Poliestere 170T | 170T polyester

☐ 150 x 70 cm



.32



88060
Calamo

Grande parasole ideale per camion e furgoni. Entrambi i lati in alluminio con bolle e bordatura nera. Include anelli di metallo con ventose ed elastici fissarlo quando ripiegato. Fornito piatto | Large sunshade ideal for trucks and vans. Double-sided bubble, made of aluminium with metal finish

Alluminio a bolle d'aria 2 lati | Bubble-wrapped aluminium 2 sides

☐ 180 x 90 cm





.01



88009
Kun

Set di 2 tendine parasole per auto, con corpo in retina. Con ventosa a T, fornita in confezione in PVC | Set of 2 folding window sunshades with mesh body in bright and varied colours. With suction cups t and PVC cover with hooks closing.

Poliestere | Polyester
44 x 37 cm



.02



88029
Olivia

Set composto da due tendine parasole per finestrino, particolarmente adatte alla stampa in sublimazione. | Set of two sunshades in window size, suitable for sublimation in full color.

Poliestere | Polyester
44 x 37 cm



.02



88084
Krusiduller

Etilometro tascabile con schermo LCD e corpo bianco liscio. Dotato di laccetto. | Pocket Breathalyzer with built-in LCD screen and plain white smooth finishing. Includes carrying belt. Presented in an attractive design box.

Plastica | Plastic
3,6 x 9,5 x 1,7 cm



.02



88062
Nanchang

Taglierino di sicurezza leggero e compatto. Ha una lama orizzontale che crea un effetto doppia lama, posizionando un bordo su ciascun lato per una maggiore facilità d'utilizzo. | Lightweight and compact safety cutter. It has a horizontal blade that creates a double blade effect, placing an edge on each side for greater ease of use.

Abs, Metallo | Abs, Metal
13 x 4 cm



.05



88052
Fundres

Disco orario, orario 12/24 | Parking disc, 12/24 hours display

Similpelle | Leatherette
11 x 14,7 x 0,2 cm



.05



88053
Gadera

Disco orario, orario 12/24 | Parking disc, 12/24 hours display

Cartone, Pu | Cardboard, Pu
10 x 12,5 x 0,2 cm



.01



17300
Angitola

Organizer pieghevole per il bagagliaio della macchina. Manici rinforzati e base rigida per un fissaggio sicuro. | Folding organizer for the boot of the car in resistant non-woven. With reinforced carrying handles, side handle, front pocket and a rigid base for a firm fitting.

TNT No-woven | TNT No-woven
34 x 28 x 25 cm

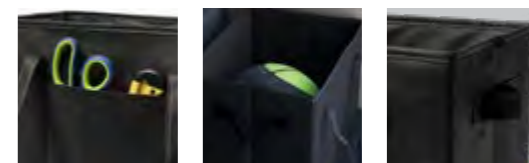



ICE SCRAPERS

Ice scraper with protective mitten in resistant polyester.

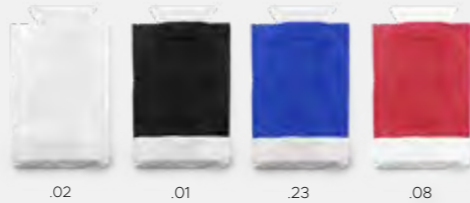

88005
Pralfio

Raschiaghiaccio con guanto protettivo | Ice scraper with protective mitten

Poliestere 210T | 210T polyester

25 x 17 x 1,5 cm



88083
Gorno

Raschia ghiaccio con gettone, luce LED e misuratore battistrada pneumatici. | Ice Scraper with coin, LED light and tyre tread calculator.

Plastica | Plastic

21 x 9,7 x 1,5 cm

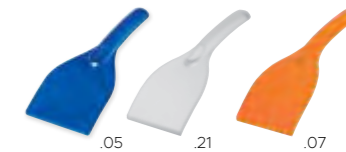
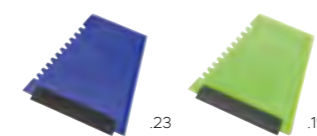

88023
Satya

Raschiaghiaccio con seghetto integrato e inserto per la pulizia. | Ice scraper with integrated saw and cleaning accessory.

Plastica | Plastic

12 x 11 x 0,3 cm



88001
Tomas

Raschiaghiaccio con materiale resistente. | Ice scraper in resistant material.

Plastica | Plastic

22 x 10,8 x 1 cm



88004
Fragana

Pratico raschia ghiaccio triangolare, con un lato dentellato e due lisci. | Practical triangular ice scraper, with one notched and two smooth sides.

PP | PP

11 x 10,5 x 0,2 cm



88067
Arre

Raschia ghiaccio con un lato dentellato e uno liscio | Ice scraper with one jagged and one smooth side

Bamboo, silicone | Bamboo, silicon

11 x 11,7 cm



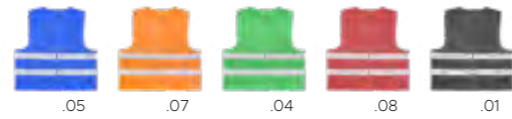

.06



88049
Taku

Gilet riflettente con chiusura in velcro. | Reflective vest with velcro closure.

Poliestere | Polyester

60 x 69 cm



CERTIFIED EN20471



88035
Patri

Gilet catarifrangente con due bande riflettenti. Certificato | Polyester reflective jacket in fluorescent colour with two reflective bands and large printing area. Certificate obtained in Europe available.

Poliestere | Polyester

65 x 70 cm



.06



45001
Saba

Portachiavi riflettente con moschettone modello gilet | Gilet shaped reflective tog with carabiner

Plastica | Plastic

4,5 x 5,6 cm



.07



88021
Paddington

Fascia da braccio riflettente | Reflective snap armband

Plastica | Plastic

30 x 3 cm

CERTIFIED EU/CE R27



.08



88024
Denza

Kit soccorso stradale | Emergency car kit

Poliestere, Plastica, Metallo | Polyester, Plastic, Metal

45 x 4,5 x 3,5 cm





Events and Festivals

Events and Festivals

Porta badge e cordini colorati, gadget per eventi formali, ma anche braccialetti, palloncini gonfiabili per feste e concerti, bandierine, palline da golf e medaglie per eventi sportivi.

Colorful badge holders and lanyards, gadgets for formal events, as well as wristbands, inflatable balloons for parties and concerts, flags, golf balls and medals for sporting events.

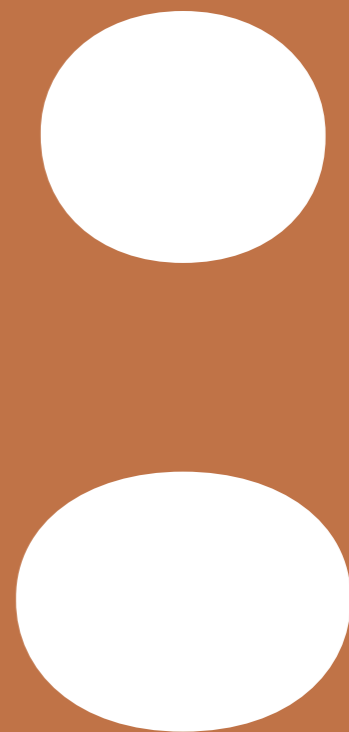



.02 .01 .23 .04

.17 .08 .07 .06



49016
Gregor

Lanyard con moschettone, fibbia in plastica, sgancio di sicurezza antisoffoco e laccetto portacellulare. | Lanyard with metal hook, plastic buckle, breakaway closure and phone holder.

Poliestere, Plastica | Polyester, Plastic

2 x 55 cm



.06 .07 .17 .16

.02 .01 .08 .03

.23 .04 .19



49032
Robert

Lanyard con moschettone in metallo | Lanyard with metallic carabiner closure.

Poliestere | Polyester

2 x 90 cm



.01 .06 .05 .04

.07 .17 .08

.02



49373
Chiaro

Lanyard con moschettone in metallo. | Lanyard with metal hook.

Poliestere RPET | RPET polyester

2 x 50 cm

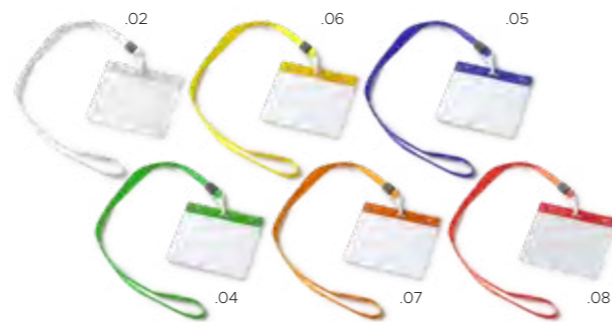

.02 .06 .05

.04 .07 .08



49055
Torsten

Lanyard con porta badge, con moschettone. | Identifier in PVC with matching colour lanyard with carabiner closure

Poliestere, Pvc | Polyester, PVC

11,2 x 48,5 x 0,5 cm



.13



49993
Bobbio

Lanyard con moschettone in metallo. | Lanyard with metal carabiner.

100% Cotone | 100% Cotton

2 x 50 cm



.13



49111
Brisa

Lanyard in cotone. Fibbia e chiusura di sicurezza sul collo in fibra di grano/PP. Con moschettone rotante in metallo. | Lanyard in cotton material. Buckle and neck safety lock in wheat straw/PP. With metallic rotating carabiner.

100% Cotone, Fibra di grano, PP | 100% Cotton, Wheat Fiber, PP

2 x 52 cm





49137
Istrana

NEW

Portachiavi rollerclip con moschettone. | Rollerclip keychain with carabiner.

Plastica | Plastic

12,5 x 1,5 cm



49136
Fior

NEW

Lanyard con rollerclip e moschettone | Lanyard with rollerclip and carabiner

Plastica | Plastic

55 x 1 cm



.32



49133
Tezze

NEW

Targhetta portanome. Spilla di sicurezza a doppia chiusura. | Name plate. Double locking safety pin.

Plastica, Alluminio | Plastic, Aluminum

6,8 x 3,4 cm



49021
Norga

Portabadge/Portaskipass con clip e cordino di 80 cm | Badge/ski pass holder with clip and 80 cm cord.

Plastica, Metallo | Plastic, Metal

3,2 x 1,5 x 8 cm



.02

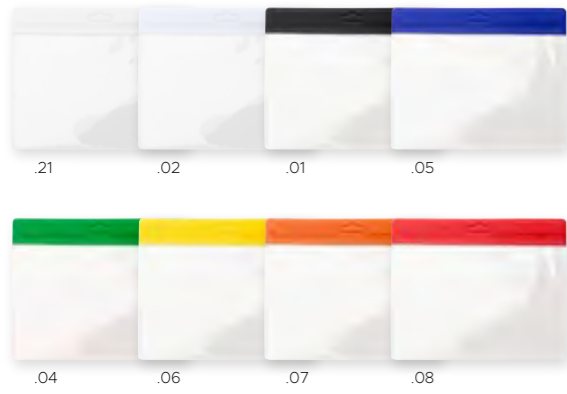

 49061
Arturo
 Portabadge | Badge holder
 Plastica | Plastic
 11 x 9,5 x 0,3 cm



 49179
Ricca
 Porta badge. | Badge holder.
 Pvc | pvc
 11,5 x 17,5 cm

 **NEW** 49000
Riyad
 Porta badge. | Badge holder.
 Pvc | pvc
 10,6 x 15 cm

YOUR BESPOKE LANYARD

RECYCLED COTTON
 ORGANIC COTTON
 BAMBOO FIBER
 TYVEK
 R-PET
 PLA

CHOOSE MATERIAL

CHOOSE COLOR

MULTI TOOLS



bespoke
 expert in special productions



.21



49135

Volpago

Lanyard portabicchiere, regolabile. | Cup holder lanyard, adjustable.

Poliestere, Silicone | Polyester, Silicone

45 x 6 cm

NEW



74276

Pettorazza

Bicchieri riutilizzabile | Reusable cup

PP | PP

11,6 x 9,2 cm



NEW



WINE GLASS HOLDER

With necklace.



.05 .01 .10



17110

Fabinho

Porta calice con tracollina. | Wine glass holder with necklace.

TNT No-woven | TNT No-woven

18 x 22,5 cm

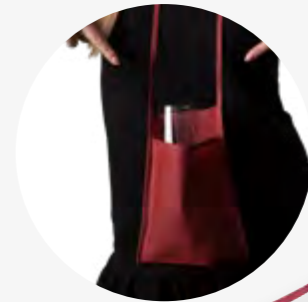

YOUR BESPOKE SILICONE BRACELET

bespoke
expert in special productions

ALTO E BASSO RILIEVO | EMBOSSY AND DEBOSSY



SILICONBRAC-1

Braccialetto in silicone | Silicone braccialet

Silicone | Silicone

20,2 x 1,2 x 0,2 cm

SERIGRAFIA | SCREEN PRINTING



SILICONBRAC-2

Braccialetto in silicone | Silicone braccialet

Silicone | Silicone

20,2 x 1,2 x 0,2 cm

ALTO E BASSO RILIEVO COLORATO | EMBOSSY AND DEBOSSY WITH COLOR



SILICONBRAC-3

Braccialetto in silicone | Silicone braccialet

Silicone | Silicone

20,2 x 1,2 x 0,2 cm



YOUR BESPOKE PIN

SIZE



Ø 25mm Ø 45mm
Ø 32mm Ø 56mm
Ø 38mm Ø 76mm



49114

PIN-1

Spilla personalizzata | Printed pin

Latta | Tin

Ø 7,6 cm



bespoke
expert in special productions

.02

YOUR BESPOKE MAGNET

Seleziona la tua forma preferita | Select your favorite shape

SIZE



Ø 38mm
Ø 56mm
Ø 76mm

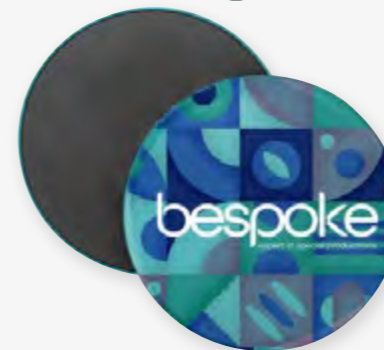

49117

MAGNET-3

Magnete personalizzato | Printed Magnet

Latta | Tin

Ø 3,8 cm

SIZE



Ø 56mm

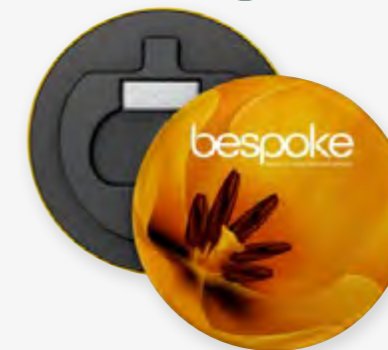

49116

MAGNET-2

Magnete personalizzato con apribottiglia | Printed Magnet with bottle opener

Latta | Tin

Ø 5,6 cm

SIZE



78x53mm



49115

MAGNET-1

Magnete personalizzato 78x53 mm | Printed Magnet 65x65 mm

Latta | Tin

7,8 x 5,3 cm

EVERYTHING FOR YOUR EVENTS

The best types of festivals and events promotional gifts.

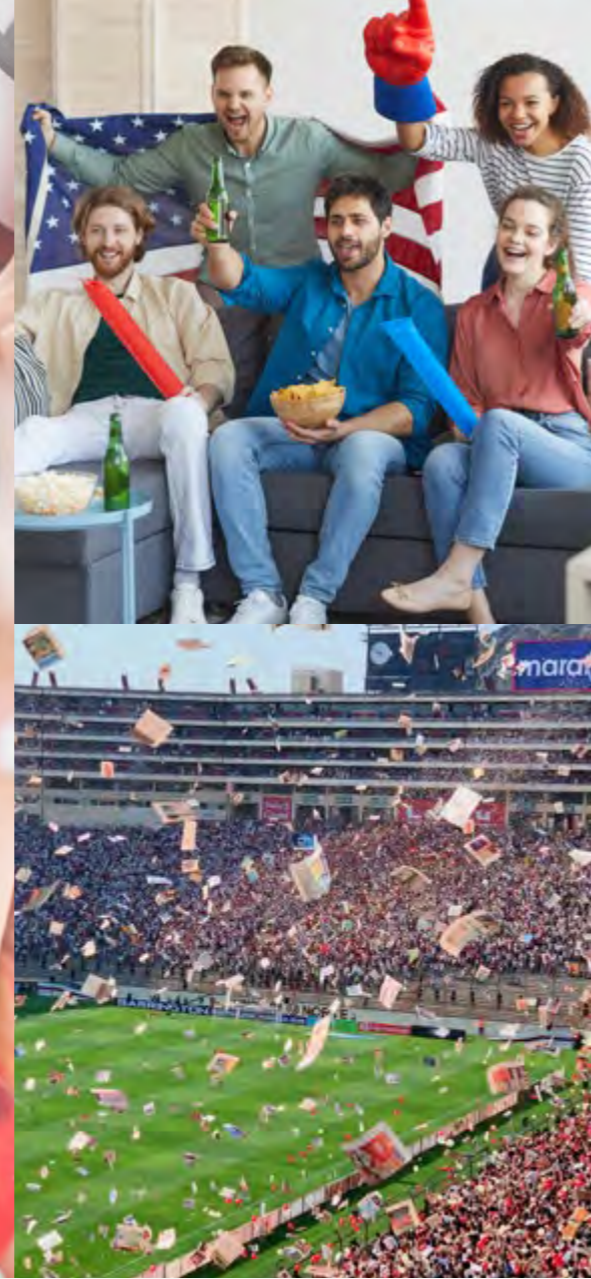

.06 SPAIN



.05 FRANCE



.02 ITALY



56107 Gruaro

Occhiali da sole con montatura colorata nei colori delle bandiere italiana, francese o spagnola. Protezione UV400 | Sunglasses with coloured frame available in different design recalling the colours of italian, french or spanish flag. Black lenses. UV400 protection

Plastica | Plastic

15 x 16,5 x 4 cm

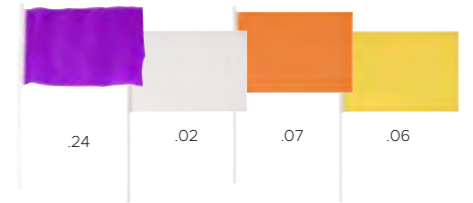

.24 .02 .07 .06

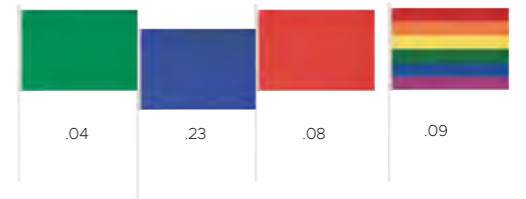

.04 .23 .08 .09



50034 Crispini

Bandierina | Pennant

Poliestere | Polyester

Flag: 21 x 14 cm - Flag pole: 30 cm



96145 Carum

Gessetti per colorare il viso | Cosmetic colours pencils

Plastica | Plastic

6,7 x 1 x 1,7 cm



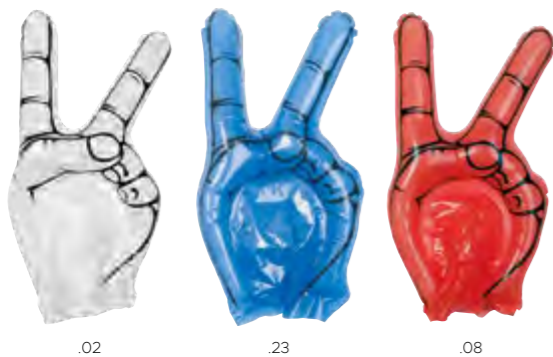

.02 .23 .08



50065
Othon

Mano gonfiabile. Riutilizzabile, con valvola di gonfiaggio | Animation hand. Reusable and with inflation valve included.

Ldpe | Ldpe

33 x 57 cm



.06



.02 ITALY .05 FRANCE .06 SPAIN .60 PORTUGAL



50114
Maserada



Set di bastoni gonfiabili per il tifo, riutilizzabili. Disegni di bandiere assortiti. Dotati di valvola di gonfiaggio. | Set of inflatable reusable cheering sticks. Assorted flag designs. Equipped with inflation valve.

Ldpe | Ldpe

61 x 10 cm



.23



.08 .04 .07



95026
Silo

Mano clapper | Two-colour clapper in the shape of a hand with handle.

Plastica | Plastic

8 x 18 x 2 cm

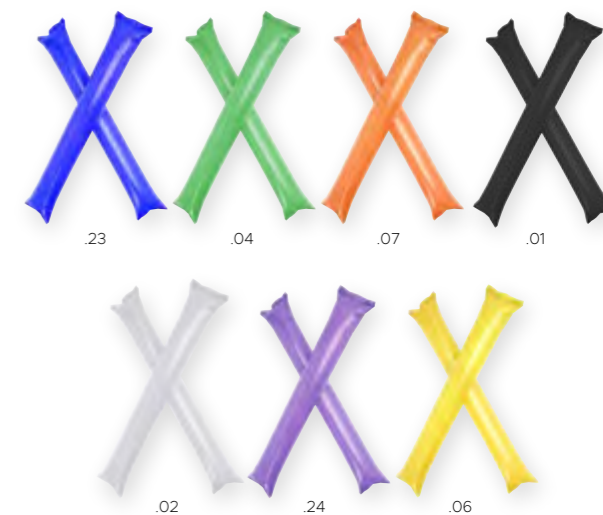

.23 .04 .07 .01
.02 .24 .06



50087
Phil

Coppia di bastoni/clapper. Riutilizzabili e con valvola di gonfiaggio. | Click-clack pair/ noisy clappers. Reusable and with inflation valve included.

Lpde | Lpde

61 x Ø 10 cm





YOUR BESPOKE BALLOON PRINT YOUR LOGO

YOUR BESPOKE BRACELETS SUBLIMATION PRINT

**Your logo
in full color**
starting from
250 pcs



41127
Odette

Bracciale monouso con stampa sublimatica su entrambi i lati | Disposable bracelet with sublimation print on both sides. Black or white plastic closure

Poliestere | Polyester

Unisex

BALLOONS ACCESSORIES



GETC-3
Compressore elettrico
Electric air compressor



GETP-2
Pompa per gonfiaggio
Air pump



GETA-4
Astina con valvole
Stick with valves



GETP-1
Pompa per gonfiaggio
Air pump



GETF-5
Filo
Wire



BALL-12

PALLONCINO BALLOON

Palloncino disponibile in 150 colorazioni, con stampa fino a 6 colori

Balloon available in 150 colors. With prinwork up to 6 colors



Stampa fino a 6 colori, da 1 lato o sull'intera superficie!

Print up to 6 colors on 1 side or all around it!

TYVEK



52007
Sonke

Braccialetto per eventi, misura adulto. Chiusura adesiva, resistente all'acqua, fornito in fogli da 10. | Events bracelet. With adhesive closure, waterproof and presented in 10 pieces die-cut sheet.

Tyvek | Tyvek

26 x 2,5 cm

PVC



52002
Eric

Braccialetto. Regolabile, chiusura autobloccante. | Bracelet with adjustable hook and loop safety lock.

Pvc | pvc

24,3 x 2 cm

SILICONE

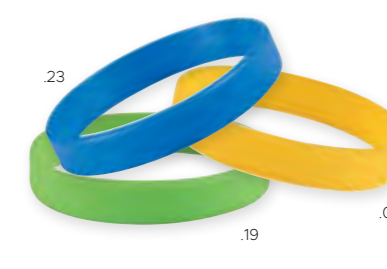

41001
Thore

Bracciale in silicone | Silicone bracelet

Silicone | Silicone

20,2 x 1,2 x 0,2 cm



.13



41136
Alpinia

Braccialetto con chiusura di sicurezza in bambù autobloccante (non riutilizzabile) | Natural cotton bracelet with bamboo safety clasp (not reusable).

Cotone naturale, Bambù | Natural Cotton, Bamboo

34,5 x 1,2 cm



.02



41192
Hortensia

Braccialetto con anellino silver per regolare la chiusura. | Adjustable bracelet in soft polyester with bright silver colour adjustment accessory.

Poliestere | Polyester

34,5 x 1,2 cm



.02



19009
Fraser

Foulard oversize triangolare | Triangle shaped headkerchief

Poliestere | Polyester

100 x 70 x 70 cm

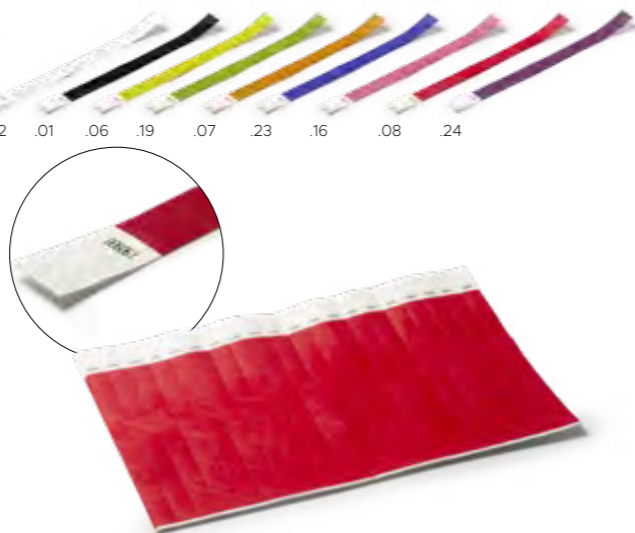

52239
Segusino

Braccialetto con numerazione individuale. Confezione da 20 unità. | Bracelet with individual numbering. Pack of 20 units.

Tyvek | Tyvek

25,4 cm



.13



95130
Illarione

Trofeo rotondo | Round trophy

Legno di pino | Pine wood

13,5 x 2 x 12,5 cm



.13



95131
Lozzo

Trofeo rettangolare | Rectangular trophy

Legno di pino | Pine wood

17 x 9 x 2,5 cm





BALL SHAPED GADGETS

Retro design ball, FIFA 5 size.



50172
Sonni

Pallone da calcio, misura 5. | Retro design ball, FIFA 5 size.

Similpelle, Pvc | Leatherette, PVC

Size 5

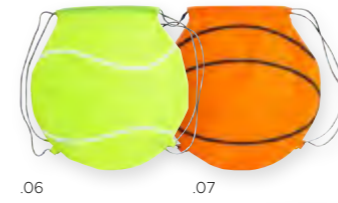

64102
Camden

Zaino sacca, con angoli rinforzati. Disponibile in 3 varianti: calcio, basket e tennis. | Drawstring backpack with reinforced corners and available in 3 designs: football, basketball and tennis.

Poliestere 210D | 210D polyester

43 x 43 cm



47201
Jackson

Portachiavi antistress disponibile in vari temi. | Antistress keychain available in different theme.

Gommapiuma | Foam rubber

Ø 4 cm



50053
Qingdao

Pallone da beach volley con cuciture ad alta resistenza | Beach volleyball ball with high resistance stitching.

Pvc | pvc

20 cm



46072
Orid

Apribottiglia con portachiavi a forma di calciatore | Football player bottle opener with keyring

Plastica, Metallo | Plastic, Metal

8 x 6,5 cm



47201
Jackson

Portachiavi antistress disponibile in vari temi. | Antistress keychain available in different theme.

Gommapiuma | Foam rubber

Ø 4 cm

ANTISTRESS



29038
Enri

Antistress a forma di pallone. | Football shaped antistress.

Gommapiuma | Foam rubber

Ø 6,3 cm



.02



.02

85 x 200 cm

200 x 95 cm



14060
Marostica

NEW

Roll-up per la personalizzazione degli eventi. | Roll-up designed for customizing events.

Alluminio | Aluminum

85 x 200 cm



14062
Ospitale

NEW

Bandiera a goccia personalizzabile con supporto a zavorra | Customizable tear-drop flag with fillable ballast support

Metallo, Pvc, poliestere, fibra di vetro | Metal, PVC, polyester, glass fiber

95 x 200 cm



.02



14061
Nervesa

NEW

Bandiera in tessuto personalizzabile all-over | All-over printable fabric flag

Poliestere | Polyester

On demand

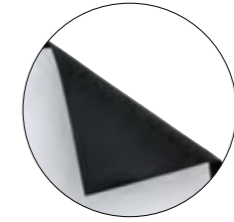

.02



18087
Castelnovo

NEW

Zerbino con superficie in poliestere adatta per sublimazione, base antiscivolo | Doormat with polyester surface suitable for sublimation, non-slip base

Poliestere | Polyester

60 x 40 cm



.02



14055
Cavaion

NEW

Gazebo, dimensioni aperto: 290 x 290 cm. Include struttura in ferro, tela di poliestere. | Gazebo, open dimensions: 290 x 290 cm. Includes iron, polyester canvas.

Ferro | Iron

300 x 300 cm

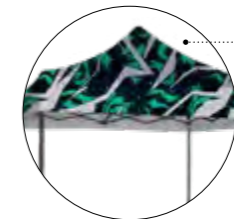

ADD YOUR CMYK
PRINT ON REQUEST



3 X 3 METERS

Packaging and Solution

La prima impressione fa sempre la differenza e per questo il packaging gioca un ruolo fondamentale nella percezione del tuo prodotto. In questo capitolo troverai sacchetti e buste per confezioni regalo, scatole di ogni forma, tipologia, materiale e misura, tutte completamente personalizzabili!

First impressions always make a difference, which is why packaging plays a key role in the perception of your product. In this chapter you will find bags and wrappings for packaging gifts, boxes of all shapes, types, materials and sizes, all fully customizable!

Packaging

and

Solution



KRAFT CARDBOARD BOXES

Perfect for gifts or as food containers.



10x10x13,5 cm



.00



17303
Longarone



Scatola in cartoncino perfetta per i regali, in formato apertura a sorpresa. | Kraft cardboard box perfect for gifts, in surprise opening format.

Cartoncino - 400gr/m2 | Card stock - 400gr/m2

20x20x25 cm

400 gr/m²



.13



29289
Xeno



Scatola regalo in cartoncino, pieghevole e con chiusura decorativa | Gift box made of cardboard, with folding format and decorative closure.

Cartoncino - 1500 gr/m2 | Cardboard - 1500 gr/m2

22,5 x 17,5 x 7 cm

1500 gr/m²



20x20x25 cm



.00



17350
Osanna



Scatola in cartoncino perfetta per i regali, in formato apertura a sorpresa. | Kraft cardboard box perfect for gifts, in surprise opening format.

Cartoncino | Cardboard

20 x 20 x 25 cm

400 gr/m²

YOUR BESPOKE CARTON BOX

Choose your shipping box and customize it with your logo!



 29284
Titano

Scatola in legno cilindrica, ideale per bottiglie, scarpe o regali. Conferisci al tuo regalo un valore aggiunto usando questa confezione regalo. | Wooden box in a cylindrical shape, ideal for storing bottles,

Legno | Wood
 Ø 8 x 32 cm



 29282
Timo

Scatola regalo cilindrica, ideale per piccoli oggetti. Conferisci al tuo regalo un valore aggiunto, usando questa confezione dallo stile moderno realizzata con materiali di qualità. | Wooden box in cylindrical shape, ideal for storing scarves, small objects

Legno | Wood
 Ø 7 x 20 cm



 29297
Fluffy

Scatola adatta per una bottiglia | Box made of MDF with capacity for one bottle.

Mdf | Mdf
 8,5 x 8,5 x 27 cm





.13



29292
Zafferano

Scatola automontante color avana per tazza | Cardboard box in brown
Cartoncino | Cardboard
12 x 9 x 10,6 cm



.02



29293
Zafferanone

Scatola automontante bianca per tazza | White cardboard box, self-assembling, for cup
Cartoncino | Cardboard
12 x 9 x 10,6 cm



.13



29303
Zinco

Scatola color avana, automontante | Cardboard box in brown, self-assembling
Cartoncino | Cardboard
25,3 x 25,9 x 10,1 cm



.02



29304
Zirconio

Scatola bianca, automontante | White cardboard box, self-assembling
Cartoncino | Cardboard
25,3 x 23,9 x 10,1 cm



.13



29294
Zenzero

Scatola automontante color avana per bottiglia/borraccia | Cardboard box in brown color, self-assembling
Cartoncino | Cardboard
8 x 8 x 26 cm



.02



29295
Ortensia

Scatola automontante bianca per bottiglia/borraccia | White cardboard box, self-assembling
Cartoncino | Cardboard
8 x 8 x 26 cm



.13



29305
Oriella

Scatola color avana, automontante | Cardboard box in brown, self-assembling
Cartoncino | Cardboard
39 x 30 x 13 cm



.02



29306
Orso

Scatola bianca, automontante | White cardboard box, self-assembling
Cartoncino | Cardboard
39 x 30 x 13 cm





.13



17512 **Montale**



Borsa con manici corti rinforzati e soffiati. | Bag with reinforced short handles and gussets.

Carta - 100gr/m2 | Paper - 100gr/m2

30x30 11 x 36 x 10 cm

100 gr/m²



.13



17353 **Tosca**
17507 **Tosca Colors**



Borsa con manici corti rinforzati e soffiati. | Bag with reinforced short handles and gussets.

Carta - 100gr/m2 | Paper - 100gr/m2

30x30 25 x 31 x 11 cm

100 gr/m²



.13



17354 **Norråker**
17508 **Norråker Colors**



Borsa con manici corti rinforzati e soffiati. | Bag with reinforced short handles and gussets.

Carta - 100gr/m2 | Paper - 100gr/m2

30x30 41 x 32 x 12 cm

100 gr/m²



.13



17355 **Nockeby**
17509 **Nockeby Colors**



Borsa con manici corti rinforzati e soffiati. | Bag with reinforced short handles and gussets.

Carta - 100gr/m2 | Paper - 100gr/m2

30x30 32 x 40 x 12 cm

100 gr/m²

SHORT HANDLES BAGS

Paper shopper in natural finish.



17322 **Maggiorana**



Borsa in carta color avana. Manici corti piatti rinforzati. Ideale per il settore alimentare (take away) | Paper shopper in natural finish. Reinforced flat short handles. Ideal for hotels and restaurants (take away).

Carta - 80 gr/m2 | Paper - 80 gr/m2

30x30 30 x 18 x 29 cm

80 gr/m²

.13



KRAFT CARDBOARD OF 280 GR/M2



17359
Badia

NEW

Borsa in carta kraft con apertura fustellata per poterla richiudere con il nastro decorativo | Bag with die-cut opening for an easy closure with decorative ribbon

Carta | Paper

22 x 15 x 7,5 cm

280 gr/m²



43252
Bagnoli

NEW



Borsa porta bottiglia realizzata in cotone. Chiusura a coulisse. Ideale per bottiglie e borracce | Bottle bag made of cotton. Drawstring closure. Ideal for bottles

Cotone - 120 gr/m² | Cotton - 120 gr/m²

12 x 33 cm

120 gr/m²



43243
Atestino

NEW



Sacchettino regalo con chiusura con coulisse | Drawstring gift bag

Cotone, velluto | Cotton, velvet

14,5 x 21 cm

140 gr/m²



17304
Delfinio

Busta con chiusura a pressione, realizzata in materiale sostenibile con finitura opaca | Presentation bag made of sustainable material with matte finish

Polipropilene ambientale (BOPP+VMPET) | Environmental Polypropylene (BOPP+VMPET)

19 x 22 cm



69028
Asigliano

NEW

Sacchettino regalo con chiusura con coulisse | Drawstring gift bag

Raso | Satin

12 x 18 cm



43244
Auranzo

NEW



Sacchettino regalo con chiusura con coulisse | Drawstring gift bag

Velluto, Cotone | Velvet, Cotton

15 x 21 cm



43245
Azzano

NEW



Sacchettino regalo con chiusura con coulisse | Drawstring gift bag

Cotone, velluto | Cotton, velvet

25 x 32 cm

140 gr/m²



43246
Eraclea

NEW



Sacchettino regalo con chiusura con coulisse | Drawstring gift bag

Cotone | Cotton

41 x 44 cm

75 gr/m²



.00



17281
Aptenia



Sacchetto in juta naturale. Chiusura con lacci in cotone. | Sack style bag made of natural jute with cotton drawstring fastening.

Juta Naturale | Natural jute

14 x 22 cm



.00



17280
Alloro



Sacchetto in juta naturale. Chiusura con lacci in cotone. | Sack style bag made of natural jute with cotton drawstring fastening.

Juta Naturale | Natural jute

25 x 32 cm



.13



43201
Yago



Bustina regalo dimensione 15x21, in cotone con chiusura con coulisse. | Gift bag size 15x21 cm, made of cotton and string closing.

Cotone - 180 gr/m2 | Cotton - 180 gr/m2

15 x 21 cm



.13



43200
Alicia



Bustina regalo dimensione 20x30, in cotone con chiusura con coulisse. | Gift bag size 20 x 30 cm, made of cotton and string closing.

Cotone - 180 gr/m2 | Cotton - 180 gr/m2

20 x 30 cm



.13



43225
Orgoglio



Sacchettino con chiusura con coulisse | Small bag with drawstring closure

Cotone | Cotton

9 x 10,5 cm



.11



17249
Dora



Sacchetto con coulisse | Drawstring bag.

100% Cotone - 105gr/m2 | 100% Cotton - 105gr/m2

15 x 21 cm



.13



43230
Cartamo



Sacchetta con coulisse, con laminazione interna | Drawstring bag with internal lamination

Cotone, PE | Cotton, PE

22,5 x 22,5 cm



.13



17296
Abutilon



Sacchetto in cotone con chiusura con coulisse. | Bag with drawstring closure.

Cotone | Cotton

27 x 35 cm



YOUR BESPOKE PACKAGINGS

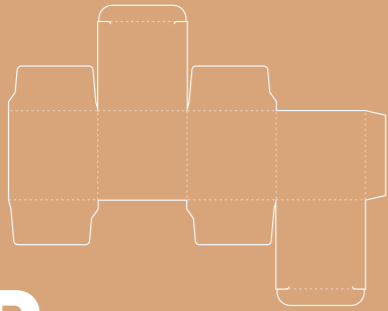

Realizza la tua scatola su misura !
Create you own packaging based on your needs!

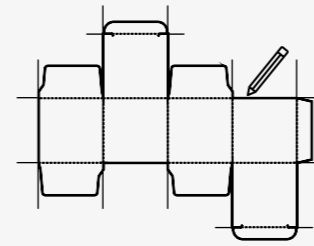

1

Scegli la forma e la misura più adatta...

Choose the shape and size you need

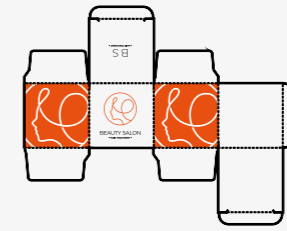

2

Crea la tua grafica per rendere unica la tua scatola..

Create your own design to make your box unique.



3

Ci pensiamo noi a dare vita alla tua idea!

We'll bring your idea to life!



bespoke
expert in special productions



bespoke
expert in special productions

YOUR IDEA TODAY CAN BECOME REALITY



BESPOKE, un brand creato per offrirti un servizio import esclusivo.
Ciò che può essere immaginato, può essere realizzato!

Offre un servizio esclusivo di sviluppo del prodotto, dal design sino alla realizzazione e certificazione dell'intero processo produttivo. Fornire un servizio import completo nello sviluppo di un marchio o nella realizzazione di campagne promozionali richiede una certa professionalità. **BESPOKE**, con più di 40 anni di esperienza nel mercato orientale, rappresenta il partner ideale.

Attraverso i nostri processi produttivi, **BESPOKE** può realizzare qualsiasi tipo di prodotto, dall'abbigliamento promozionale alle divise da lavoro e DPI, così come oggetti promozionali ideali per qualsiasi occasione e/o attività promozionale.

BESPOKE, a new brand for an exclusive import service.
What can be imagined, can be developed!

It offers an exclusive service of product development, from designing and sourcing, to the realization and certification of the whole process.

It requires a well-rounded professional in import to promote ones' brand in an effective manner. That is why **BESPOKE** is the ideal partner to support you through this process, with its more than 40 years' experience in the eastern market.

Through our production processes, **BESPOKE** is able to produce any kind of product, from promotional clotheslines to work uniforms and PPEs - but also promotional items suitable for any occasion and / or merchandising.



REQUEST OUR TEXTILE CATALOGUE

LIMITED COLLECTION
ECO COLLECTION
CASUAL SUMMER
CASUAL WINTER
SPORTS
KIDS
HEADWEAR & ACCESSORIES
FOOTWEAR



Textile Collection











Workwear Collection

































































INDEX

OF OUR ICONS REPRESENTED IN THE CATALOG

- | | | |
|---|--|---|
|  Linea naturale / Natural line |  Radio FM |  Fogli bianchi / White sheets |
|  Linea ecologica / Eco line |  Micro SD |  Fogli quadrettati / Squared sheets |
|  Penne riciclate / Recycled pen |  Usb Tipo C / USB type C |  Fogli con le righe / Striped sheets |
|  Penna inclusa / Pen included |  Carica rapida / Fast charging |  Colore dei fogli / Color sheets |
|  Colore refill / Color refill |  Funzione luce / Light function |  Fogli riciclati / Recycled paper sheets |
|  Matita temperata / Sharped pencil |  Caricatore senza fili / Wireless charger |  Nastro escluso / Ribbon excluded |
|  Matita da temperare / Unsharped pencil |  Accessori auto / Car accessories |  Protezione UV / UV protection |
|  Touch screen |  Indicato per attività sportive / Suitable for sports |  Tasca anti scippo / Anti theft pocket |
|  Capacità (mAh) / Capacity (mAh) |  Resistente all'acqua / Water resistant |  Gancio per trolley / Trolley strap |
|  Capacità (GB) / Capacity (GB) |  Telecamera / Camera |  Con lucchetto / With padlock |
|  Connessione USB / Usb connection |  Per dispositivi Apple / For Apple devices |  Porta computer / PC folder |
|  Connessione senza fili / Wireless connection |  Per dispositivi Android / For Android devices |  Bagaglio a mano / Hand luggage |
|  Connessione Bluetooth / Bluetooth connection |  Doppia parete termica / Thermal double wall |  Scatola singola / Single box |
|  Uscita audio / Earphone output |  Capacità (ml) / Capacity (ml) |  Sublimazione / Sublimation |
|  Protezione RFID / RFID protection |  Grammatura / Fabric weight |  Ideale per computer / Suitable for computers |
|  Batterie incluse / Batteries included |  Pannelli / Panels |  Ideale per dispositivi mobili / Suitable for devices |
|  Batterie non incluse / Batteries excluded |  Taglia bambino / Kids size |  Linea Antibatterica / Antibacterial line |
|  Cavo incluso / Cable included |  Numero di pagine / Number of pages |  Novità di quest'anno / New this year |
|  Cavo escluso / Cable excluded |  Formato fogli / Format sheets |  Fabbricato in Europa / Made in Europe |

COLOR GUIDE

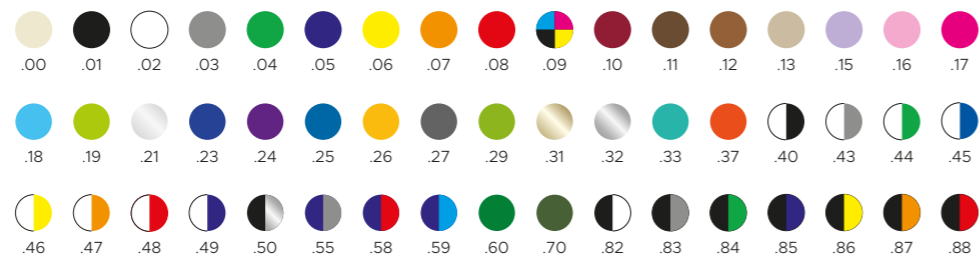

Tramite le pagine del nostro catalogo, intendiamo offrire informazioni a carattere generale in relazione ai nostri prodotti e, resta inteso che il contenuto delle stesse non deve essere considerato né esaustivo né completo. Tutte le immagini, le inserzioni, i colori, le misure e qualsiasi altra informazione in esso contenute hanno finalità meramente indicativa dei prodotti. Ci riserviamo il diritto di effettuare modifiche quando e dove necessario.

Decliniamo qualunque responsabilità in ordine ad errori od omissioni che dovessero eventualmente presentarsi

The pages of our catalogue offer just general information in relation to our products, their content must not be considered exhaustive or complete. All the images, insertions, colors, measures and any other information contained therein are merely indicative. We reserve the right to make changes when and where necessary. We decline any responsibility for errors or omissions that may occur.

The Gifts
Collection